

Section 6

At Grade Intersections

6.1 General

Most highways intersect at grade. To minimize the resulting conflicts and to provide adequately for the anticipated crossings and turning movements, the geometric design of the intersection at grade must be given careful consideration.

Although intersections have many common factors, they are not subject to a set treatment, and must be looked upon on a case by case basis.

In varying degrees, four basic factors enter into the design of an intersection. These factors are traffic, physical, economic, and human.

- Traffic factors to be considered include:
 - Possible and practical capacities
 - Turning movements
 - Size and operating characteristics of vehicles
 - Control of movements at points of intersection
 - Vehicle speeds
 - Pedestrian Activity and movements
 - Bicycle Activity and movements
 - Bicycle operating space
 - Transit operations
 - Crash experience
- Physical factors which control intersection design and application of channelization are:
 - Topography
 - Abutting land use
 - Geometric features of the intersecting roadways
 - Traffic control devices
 - Safety features
- Economic factors, which are important and often controlling, include:
 - Cost of improvements
 - Effect on abutting businesses where channelization restricts or prohibits certain vehicular movements within the intersection area
- Human factors such as:
 - Driving, pedestrian, and bicyclist habits
 - Ability of drivers, pedestrians, and bicyclists to make decisions
 - Effect of surprise events
 - Decision and reaction times
 - Natural paths of movements must be considered
 - Types of pedestrians

An intersection may be extremely simple, or highly developed depending on the proper evaluation of the foregoing factors. In the redesign of an existing intersection, standards sometimes must be compromised due to the high cost of existing development or to the necessity of meeting rigid physical controls. In the design of a new intersection,

however, such controls frequently can be avoided by a shift in line or grade of one or both of the intersecting highways.

For further general discussion and details, see AASHTO – *A Policy on Geometric Design of Highways and Streets*.

6.2 General Design Considerations

6.2.1 Capacity Analysis

Capacity analysis is one of the most important considerations in the design of intersections. This is especially true in the design of at-grade intersections on urban streets and highways. Optimum capacities can be obtained when intersections include auxiliary lanes, proper use of channelization, and traffic control devices. Where these techniques are under consideration, it is necessary to consider pedestrian and bicycle safety and level of service. Reference is made to the *Highway Capacity Manual*, Transportation Research Board, for procedures in performing capacity computations.

6.2.2 Spacing

The spacing of intersections on major arterials is important to the capacity and safety of the roadway. In urban areas, the capacity of the arterial is determined by the capacity of the signalized intersections along the roadway. Ideally, signalized intersections should be located no closer than 1200 feet apart. In rural areas, the minimum spacing of intersections should be one half mile.

6.2.3 Alignment and Profile

Intersections are points of conflict between vehicles, bicycles, and pedestrians. The alignment and grade of the intersecting roads should permit drivers to discern and perform readily the maneuvers necessary to pass through the intersection safely and with minimum interference between vehicles. To these ends, the horizontal alignment should be as straight as possible and gradient as flat as practical. The sight distance should be equal to or greater than the minimum values for the specific intersection conditions. Sight distance is discussed later in this section.

1. Alignment

Regardless of the type of intersection, intersecting highways should meet at or nearly at right angles. Roads intersecting at acute angles require extensive turning roadway areas. Intersection angles less than 60 degrees normally warrant realignment closer to 90 degrees. Intersections on sharp curves should be avoided wherever possible because the superelevation and widening of pavements on curves complicate the intersection design. Furthermore, since traffic stripes are not normally carried through the intersection, there is no visual reference for the guidance of the driver through the intersection curve during adverse weather and visibility conditions.

2. Profile

Combinations of profile lines that make vehicle control difficult should be avoided. Substantial grade changes should be avoided at intersections, although it is not always feasible to do so. Adequate sight distance should be provided along both highways and across corners, even where one or both intersecting highways are on vertical curves.

The grades of intersecting highways should be as flat as practical on those sections that are to be used for storage space for stopped vehicles. A minimum storage space for 2 vehicles, approximately 50 feet, should be provided for minor streets where stop

sign control is employed and the approach grade is up towards the intersection. Such slopes should desirably be less than one percent and no more than 3 percent.

The profile lines and cross sections on the intersection legs should be adjusted for a distance back from the intersection proper to provide a smooth junction and proper drainage. Normally, the profile line of the major highway should be carried through the intersection, and that of the cross road adjusted to it. Intersections with a minor road crossing a multi-lane divided highway with narrow median and superelevated curve should be avoided whenever possible because of the difficulty in adjusting grades to provide a suitable crossing. Profile lines of separate turning roadways should be designed to fit the cross slopes and longitudinal grades of the intersection legs.

As a rule, the horizontal and vertical alignments are subject to greater restrictions at or near intersecting roads than on the open road. Their combination at or near the intersection must produce traffic lanes that are clearly visible to the motorists, bicyclists, and pedestrians at all times and definitely understandable for any desired direction of travel, free from sudden appearance of potential hazards, and consistent with the portions of the highway just traveled.

6.2.4 Cross Section

The cross section of the pavement surface within an intersection should be reviewed on a case-by-case basis. The development of the centerline profiles and edge of pavement profiles should flow smoothly through the intersection.

6.3 Sight Distance

6.3.1 General

There must be unobstructed sight along both roads at an intersection and across their included corner for distances sufficient to allow the operators of vehicles approaching the intersection or stopped at the intersection to observe pedestrians and cyclists and carry out whatever maneuvers may be required to negotiate the intersection. It is of equal importance that pedestrians be able to view and react to potential conflicts with vehicles.

Any object within the sight triangle high enough above the elevation of the adjacent roadways to constitute a sight obstruction should be removed or lowered. Such objects include but are not limited to cut slopes, hedges, bushes, tall crops, signs, buildings, parked vehicles, etc. Also check the vertical curve on the highway to see if it obscures the line of sight from the driver's eye (3.5 feet above the road) to the approaching vehicle (3.5 feet above the road) as per the sight distance determined in the next three sections.

6.3.2 Sight Distance for Bicycle Facilities

In general the sight distance required to see a bicycle is no greater than that to see a vehicle, so bicycle sight distance need not be calculated at intersections also used by vehicles. At locations where a separated bicycle facility crosses the roadway, or elsewhere where cyclists may enter or cross the roadway independent of vehicles, appropriate sight distance should be provided.

Vehicles parked near crosswalks create sight distance problems, and for this reason New Jersey State Statutes prohibit motor vehicle parking "within 25 feet of the nearest crosswalk or side line of a street or intersecting highway, except at alleys," and within 50 feet of a stop sign (Title 39:4-138). These relationships also apply to other locations where pedestrians are likely to cross (mid-block crosswalks, T-intersections, gaps in median barriers).

The parking setback distance can be reduced in locations where curb extensions have been provided to reduce crossing distance and increase the visibility of pedestrians as long as the provisions of Title 39 are also met.

6.3.3 Stop Control on Cross Street

Intersection designs should provide sufficient sight distances to avoid potential conflicts between vehicles turning onto or crossing a highway from a stopped position and vehicles on the through highway operating at the design speed.

As a minimum stopping sight distance must be provided. However, to enhance traffic operations, the recommended sight distance along the major roadway from Figure 6-A for various design vehicles to turn left, right or cross should be provided. Where the median width on a divided highway is 6 feet or greater than the vehicle length, the crossing can be accomplished in 2 steps. The vehicle crosses the first pavement, stops within the median opening, and proceeds when a safe gap in traffic occurs to cross the second pavement. However, when the median width is less than that of a vehicle, the crossing must be made in one step and the median must be included as part of the roadway width (w).

6.3.4 Yield Control

When an intersection is controlled by a yield sign, the sight triangle is governed by the design speed on the main highway and that of the approach highway or ramp.

Suggested approach speeds on the yield controlled approach are 15 mph for urban conditions and 20 mph to 25 mph for rural conditions. Where two major highways intersect and one leg is controlled by a yield sign, the design speed on both highways should be used in determining the minimum sight triangle.

Figure 6-B illustrates the method for establishing the recommended sight triangle for yield controlled intersections.

The table "WITH ACCELERATION LANE" is from Exhibit 9-51 of AASHTO - *A Policy on Geometric Design of Highways and Streets*. The distances shown in this table are less than the stopping sight distance for the same design speed. Since motorists slow down to some extent on approaches to uncontrolled intersections, the provision of a clear sight triangle with legs equal to the full stopping sight distance is not essential.

The recommended distances in the bottom table "WITHOUT ACCELERATION LANE" are from Exhibit 9-64, of AASHTO - *A Policy on Geometric Design of Highways and Streets*. Yield -controlled approaches without acceleration lanes generally need greater sight distance than stop controlled approaches. If sufficient sight distance for yield control is not available, use of a stop sign instead of a yield sign should be considered. Another solution to where the recommended sight distance cannot be provided, consider installing regulatory signs to reduce the speed of the approaching vehicles.

6.3.5 Sight Distance at Signalized Intersections

Intersections controlled by traffic signals presumably do not require sight distance between intersecting traffic flows because the flows move at separate times.

However, drivers should be provided with some view of the intersecting approaches in case a crossing vehicle, bicycle or pedestrian violates the signal indication.

In addition, sight distance requirements for vehicles permitted to turn right on red signal indications must be considered. Line-of-sight should consider the effect of parked vehicles. As a minimum, stopping sight distance should be provided.

SIGHT DISTANCE AT INTERSECTIONS FOR LEFT, OR RIGHT TURNING & CROSSING VEHICLES WITH STOP CONTROL

FIGURE: 6-A

BDC07MR-05

Intersection Sight Distance(d) Stop Control on Minor Road Two Lane Highway						
Design Speed	Left-Turn			Right-Turn or Cross		
	P	SU	WB	P	SU	WB
25	280	350	425	240	315	385
30	335	420	510	290	375	465
35	390	490	595	335	440	540
40	445	560	680	385	500	620
45	500	630	760	430	565	695
50	555	700	845	480	625	775
55	610	770	930	530	690	850
60	665	840	1015	575	750	930
65	720	910	1100	625	815	1005
70	775	980	1185	670	875	1085

For highways with more than 2 lanes or when approach grade on minor road exceeds 3%, the distance (d) must be calculated using the formula: $d = 1.47Vt_g$

Design Vehicle	Time Gap, t_g Left-Turn	Time Gap, t_g Right-Turn & Cross
P	7.5 (See Notes)	6.5 (See Notes)
SU	9.5 (See Notes)	8.5 (See Notes)
WB	11.5 (See Notes)	10.5 (See Notes)

- Notes: 1. For left turn or crossing add 0.5 sec. for P and 0.7 sec. for SU & WB for each additional lane crossed.
 2. For each percent the upgrade on minor road exceeds 3%, add 0.1 sec for right turn or crossing and 0.2 sec for left turn

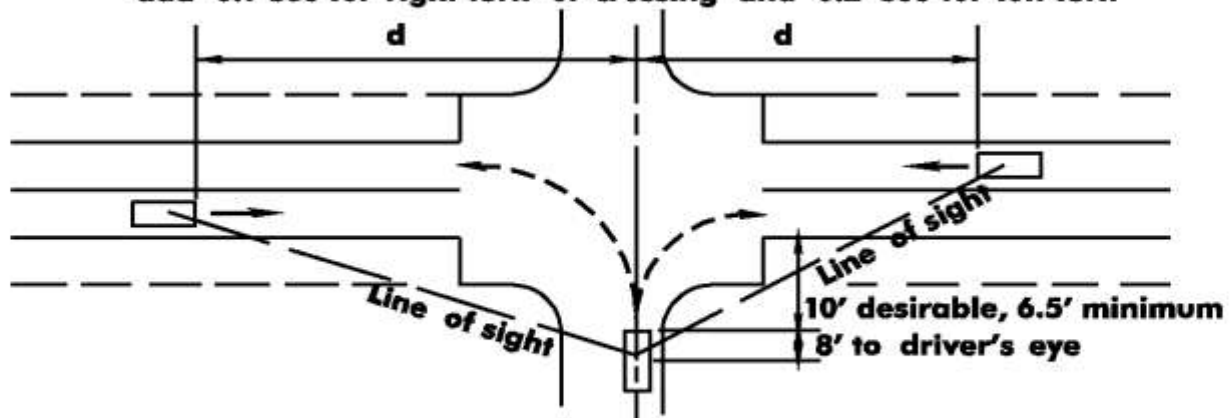

Source: A Policy on Geometric Design of Highways and Streets.

YIELD CONTROL

FIGURE: 6-B

BDC07MR-05

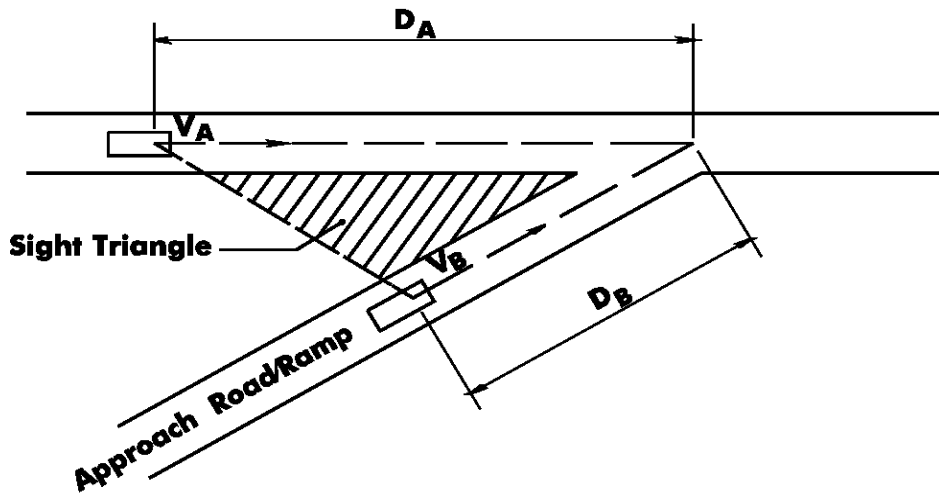

WITH ACCELERATION LANE

DESIGN AND/OR APPROACH SPEED (mph) V_A OR V_B	DISTANCE (ft) D_A OR D_B
20	90
25	115
30	140
35	165
40	195
50	245
60	325
70	405

WITHOUT ACCELERATION LANE (See Note)

DESIGN SPEED (mph) V_A OR V_B	DISTANCE (ft) D_A	DISTANCE (ft) D_B
20	240	115
25	295	155
30	355	200
35	415	250
40	475	305
50	590	425
60	710	570
70	825	730

Note: For ramps and minor roads $D_B=82$ ft. For major roads use D_B from chart.

6.4 Vehicular Turning Movements

6.4.1 General

One of the primary concerns of intersection design is to provide adequately for left and right turning movements. The pavement and roadway widths of turning roadways at intersections are governed by the volumes of turning traffic and the types of vehicles to be accommodated.

6.4.2 Design Vehicles

The overall dimensions of the design vehicles considered in geometric design are shown in Table 2-2 of Section 2, General Design Criteria. The minimum turning radii of design vehicles could be obtained from *Geometric Design of Highways and Streets*, AASHTO. Figure 6-C provides general design guidelines.

The AASHTO figures should be used as guides in determining the turning radii at intersections and the widths of turning roadways. The principal dimensions affecting design are the minimum turning radius and those affecting the path of the inner rear tire, tread width and wheel base. The paths shown for the several design vehicles are established by the outer trace of the front overhang and the path of the inner rear wheel.

Due to the greater usage of the 8.5 foot wide, 48 foot long trailers, the designer should use the WB-62 turning template when designing new intersections or upgrading existing intersections. However, the designer is cautioned not to arbitrarily provide for these larger vehicles in the design of all intersections. For example, if the turning traffic is almost entirely passenger cars, it may not be cost-effective to design for large trucks, provided that an occasional large truck can turn by swinging wide and encroaching on other traffic lanes without disrupting traffic significantly. When selecting the appropriate design vehicle, the designer is encouraged to use vehicle classification counts. Also, the existing land use and/or zoning requirements may be useful in selecting the appropriate design vehicle. However, selection of the design vehicle will depend on the designer's judgment after all the conditions have been analyzed and the effect of the operation of larger vehicles has been evaluated.

It is very possible that the use of more than one design vehicle may be appropriate. As an example, the design of one quadrant of the intersection may warrant the use of a SU truck or passenger vehicle while another quadrant may warrant the use of the WB-62.

It is further recommended that all interstate and freeway ramp terminals be designed to accommodate the WB-62 design vehicle.

The use of the WB-62 design vehicle should also be considered when designing ingress and egress to commercial or industrial buildings along the state highways.

6.4.3 Turning Radii at Unchannelized Intersections

Where it is necessary to provide for turning vehicles within minimum space and slow speeds (less than 10 mph), as at unchannelized intersections, the minimum turning paths of the design vehicles apply.

Large turning radii allow vehicles to turn at higher speeds and increase the pedestrian crossing distance. Both factors affect pedestrian safety and comfort. Large radii consume space that could be used by waiting pedestrians, may make pedestrians less visible to drivers, and make vehicles more difficult for pedestrians to see. However, curbs that protrude into the turning path of vehicles may result in larger vehicles damaging the curb and other street infrastructure, and endanger pedestrians standing at the curb. The design must balance these complex issues.

Turning radii design should be based on the “effective” turning radius of the design vehicle, rather than the actual corner radius see Figure 6-C. Where the travel lane abuts the curb, the effective and actual radius will be similar. Where there are parking lanes, bicycle lanes or a shoulder, the effective turning radius should be measured from the edge of the travel lane.

For most simple intersections with angle of turn of 90 degrees or less, a single circular arc joining the tangent edges of pavement provides an adequate design. Generally, an effective radius of 15 feet to 25 feet is adequate for passenger vehicles. Effective radii of 30 feet should be provided to allow an occasional truck or bus to turn without much encroachment. Larger effective radii should be provided where large truck combinations and buses turn frequently.

When provisions must be made for the larger truck units, and the angle of turn exceeds 90 degrees, a 3-centered compound curve may be used in lieu of a single circular arc with a large radius.

Figure 6-C indicates the minimum treatment at unchannelized intersections. See Traffic Calming Section for information on reduced turning radii as a traffic calming and pedestrian safety measure.

INTERSECTION TURNING RADII

FIGURE: 6-C

BDC07MR-05

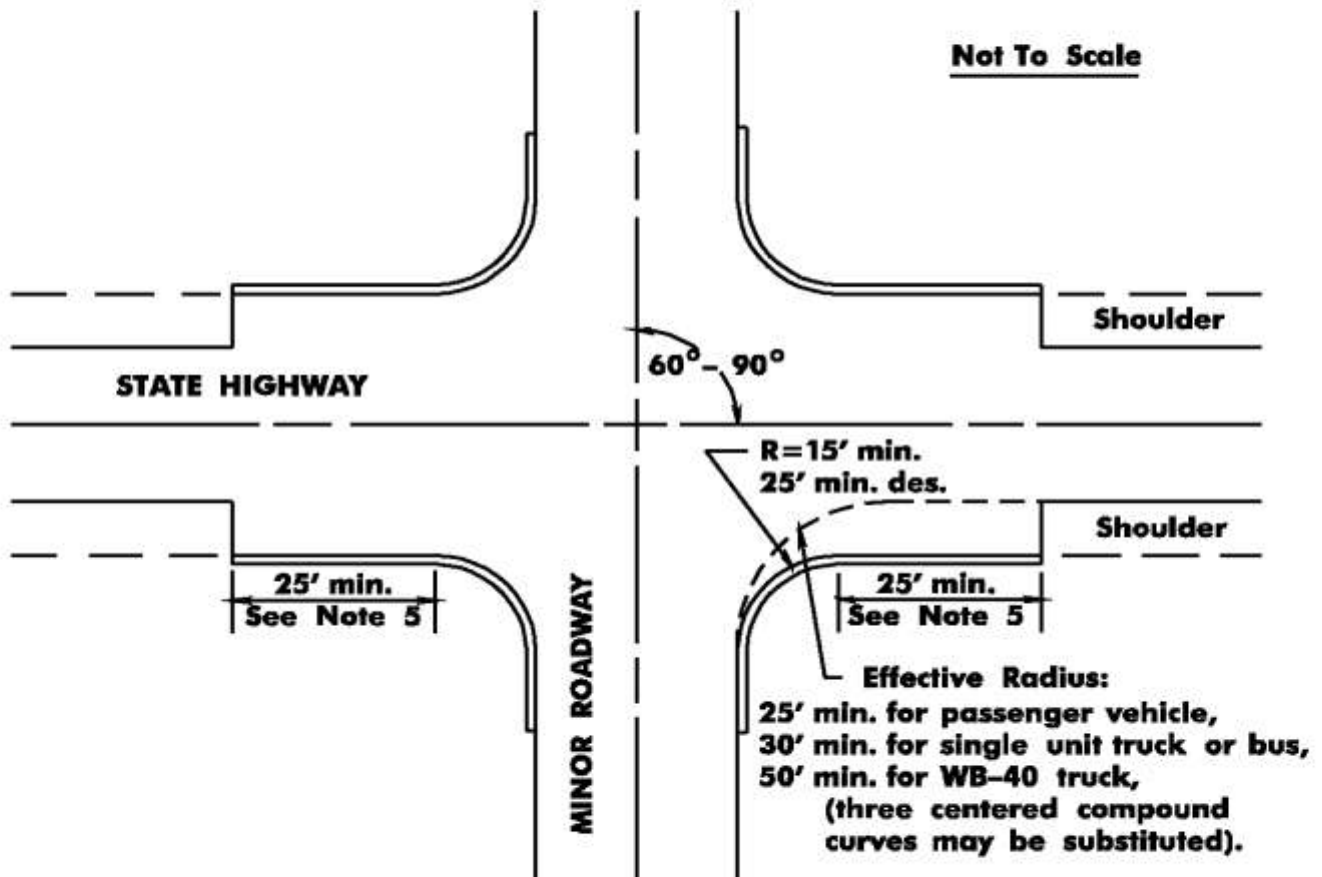

DESIGN GUIDELINES

1. Physical curb return should be clear of effective radius.
2. Truck volumes dictate the theoretical radius to be used. Where truck traffic is light, a SU truck radius should be used where possible.
3. A turning template for the appropriate design vehicle should be used to check the effective turn radii, especially for WB-50 and WB-62 trucks.
4. For intersection skew angles less than 60° , channelization should be provided.
5. Where turning volumes are high, auxiliary lanes through the intersection may be warranted.
6. Check applicable sight distances.

6.5 Channelization

6.5.1 General

Where the inner edges of pavement for right turns at intersections are designed to accommodate semi-trailer combinations, or where the design permits passenger vehicles to turn at speeds of 15 mph or more, the pavement area at the intersection may become excessively large for proper control of traffic. To avoid this condition, a corner island, curbed or painted, should be provided to form a separate turning roadway.

At-grade intersections having large paved areas, such as those with large corner radii and those at oblique angle crossings, permit and encourage undesirable vehicle movements, require long pedestrian crossings, and have unused pavement areas. Even at a simple intersection, appreciable areas may exist on which some vehicles can wander from natural and expected paths. Conflicts may be reduced in extent and intensity by a layout designed to include islands. For the design of 3-centered curves for right angle turns with corner islands and oblique angle turns with corner islands, see *A Policy on Geometric Design of Highways and Streets*, AASHTO, Exhibit 9-41 and Exhibit 9-42 respectively.

6.5.2 Islands

An island is a defined area between traffic lanes for control of vehicle movements. Islands also provide an area for pedestrian refuge and traffic control devices. Within an intersection, a median or an outer separation is considered an island. This definition makes evident that an island is no single physical type; it may range from an area delineated by curbs to a pavement area marked by paint.

Islands generally are included in intersection design for one or more of the following purposes:

- Separation of conflicts;
- Control of angle of conflict;
- Reduction in excessive pavement areas;
- Regulation of traffic and indication of proper use of intersection;
- Arrangements to favor a predominant turning movement;
- Protection of pedestrians;
- Protection and storage of turning and crossing vehicles;
- Location of traffic control devices;
- Traffic calming and speed moderating purposes;

Islands generally are either elongated or triangular in shape, and are situated in areas normally unused as vehicle paths. The dimensions depend on the particular intersection design. Islands should be located and designed to offer little hazard to vehicles and bicycles, be relatively inexpensive to build and maintain, and occupy a minimum of roadway space but yet be commanding enough that motorists will not drive over them. Island details depend on particular conditions and should be designed to conform to the general principles that follow.

Curbed islands are sometimes difficult to see at night because of the glare from oncoming headlights or from distant luminaires or roadside businesses. Accordingly, where curbed islands are used, the intersection should have fixed-source lighting.

When various intersections are involved in a given project and the warrants are sufficiently similar, a common geometric design for each intersection should be used. This design approach will enhance driver expectancy. The designer should also refer to Part V of the *Manual on Uniform Traffic Control Devices for Streets and Highways* (MUTCD) for guidance.

Painted, flush medians and islands may be preferred to the curbed type under certain conditions including the following: in lightly developed areas; at intersections where approach speeds are relatively high; where there is little pedestrian traffic; where fixed-source lighting is not provided; and where signals, signs, or lighting standards are not needed on the median or island.

Islands may be grouped into 3 major functional classes: (1) channelizing islands designed to control and direct traffic movement, usually turning, (2) divisional islands designed to divide opposing or same-direction traffic streams, usually through movements, and (3) refuge islands to provide refuge for pedestrians. Most islands combine 2 or all of these functions:

1. Size

Island sizes and shapes vary materially from one intersection to another. Islands should be large enough to command attention. The smallest curbed island that normally should be considered is one that has an area of approximately 50 square feet for urban streets, and 75 square feet for rural intersections. However 100 square feet is the minimum desirable size for islands used in both urban and rural areas.

2. Approach-End Treatment

The approach end of a curbed island should be conspicuous to approaching drivers and should be physically and visually clear of vehicle paths, so that drivers will not veer from the island.

The nose offset should be 3 feet from the normal edge of through lane. Figure 6-D shows the recommended design details of curbed triangular islands under conditions of no shoulder on the approach roadways.

On highways with auxiliary lanes or shoulders, the corner islands should be offset the full auxiliary lane or shoulder width on both the main highway and the cross road as shown in Figure 6-E.

3. Divisional Islands

The most common type of elongated divisional island is the median island, for which a design guide is illustrated on Figure 6-F.

4. Bicycle Accommodation

Raised channelization islands should be located so as not to interfere with bicycle traffic.

5. Pedestrian Accommodations

Along with their function of controlling and directing traffic movement (usually turns), and dividing traffic streams, islands may serve to enhance the safety and comfort of pedestrians crossing at intersections and midblock locations by providing a refuge. When channelizing islands are designed for this purpose, they are often termed "pedestrian crossing islands" or "median refuges."

ISLANDS WITH NO SHOULDERS

FIGURE: 6-D

BDC07MR-05

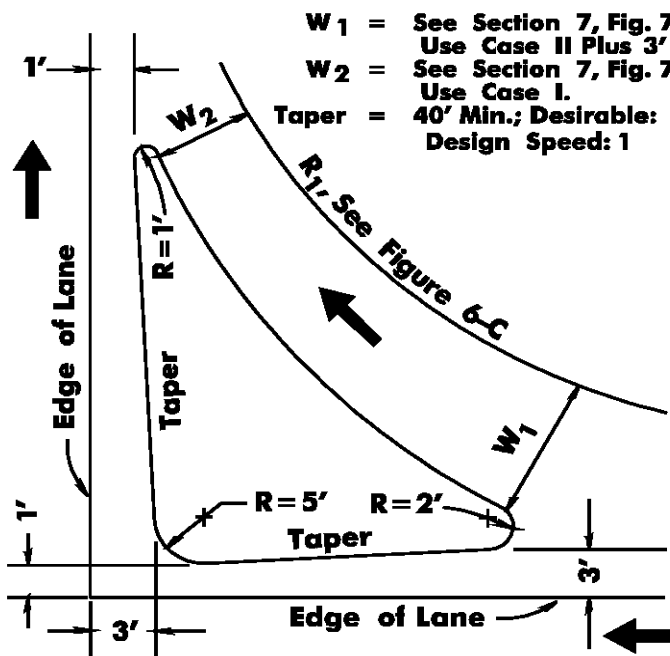

W_1 = See Section 7, Fig. 7-B, Use Case II Plus 3'
 W_2 = See Section 7, Fig. 7-B Use Case I.
 Taper = 40' Min.; Desirable: Design Speed: 1

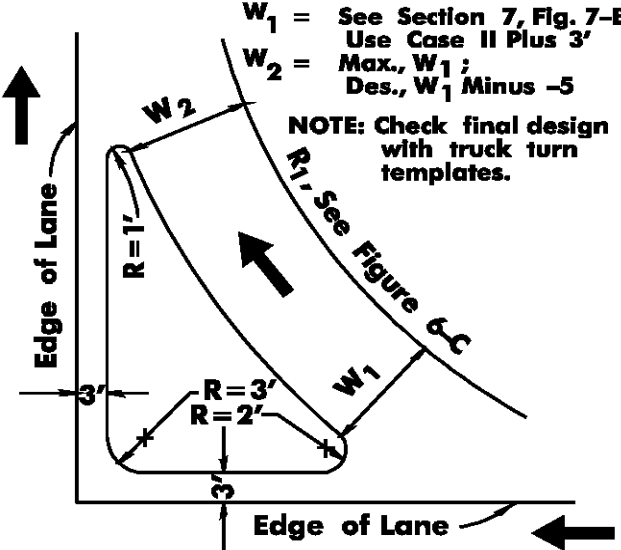

W_1 = See Section 7, Fig. 7-B, Use Case II Plus 3'
 W_2 = Max., W_1 ; Des., W_1 Minus -5
 NOTE: Check final design with truck turn templates.

LARGE ISLANDS

SMALL & INTERMEDIATE ISLANDS

NOT TO SCALE

ISLANDS WITH SHOULDERS OR AUXILIARY LANES

FIGURE: 6-E

BDC07MR-05

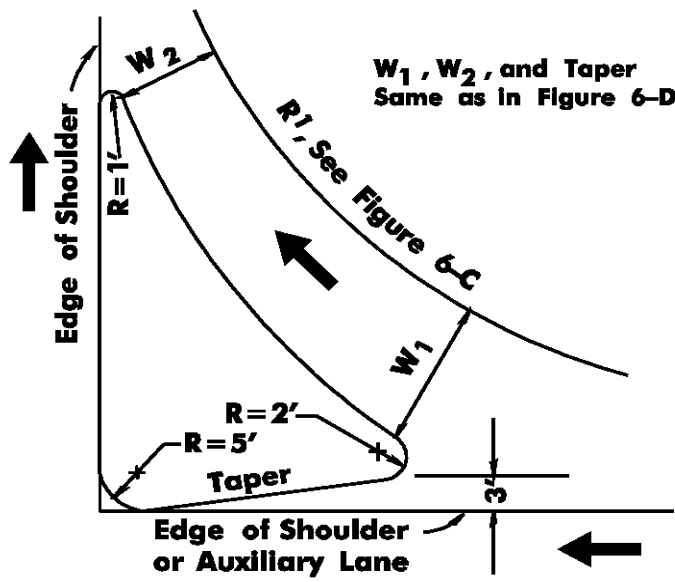

W_1 , W_2 , and Taper Same as in Figure 6-D.

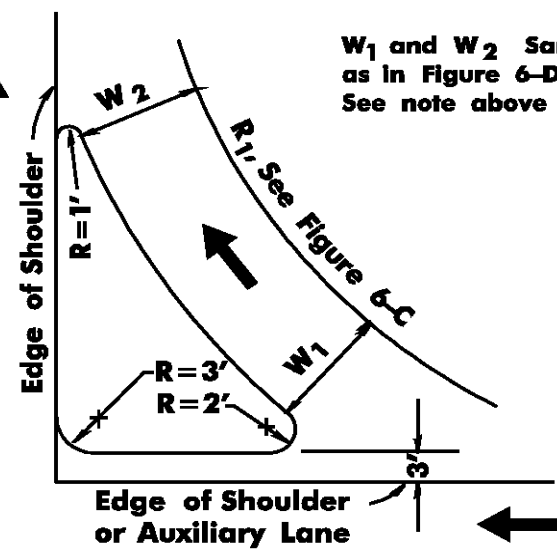

W_1 and W_2 Same as in Figure 6-D. See note above

LARGE ISLANDS

SMALL & INTERMEDIATE ISLANDS

NOT TO SCALE

DIVISIONAL ISLAND TREATMENT

FIGURE: 6-F
BDC07MR-05

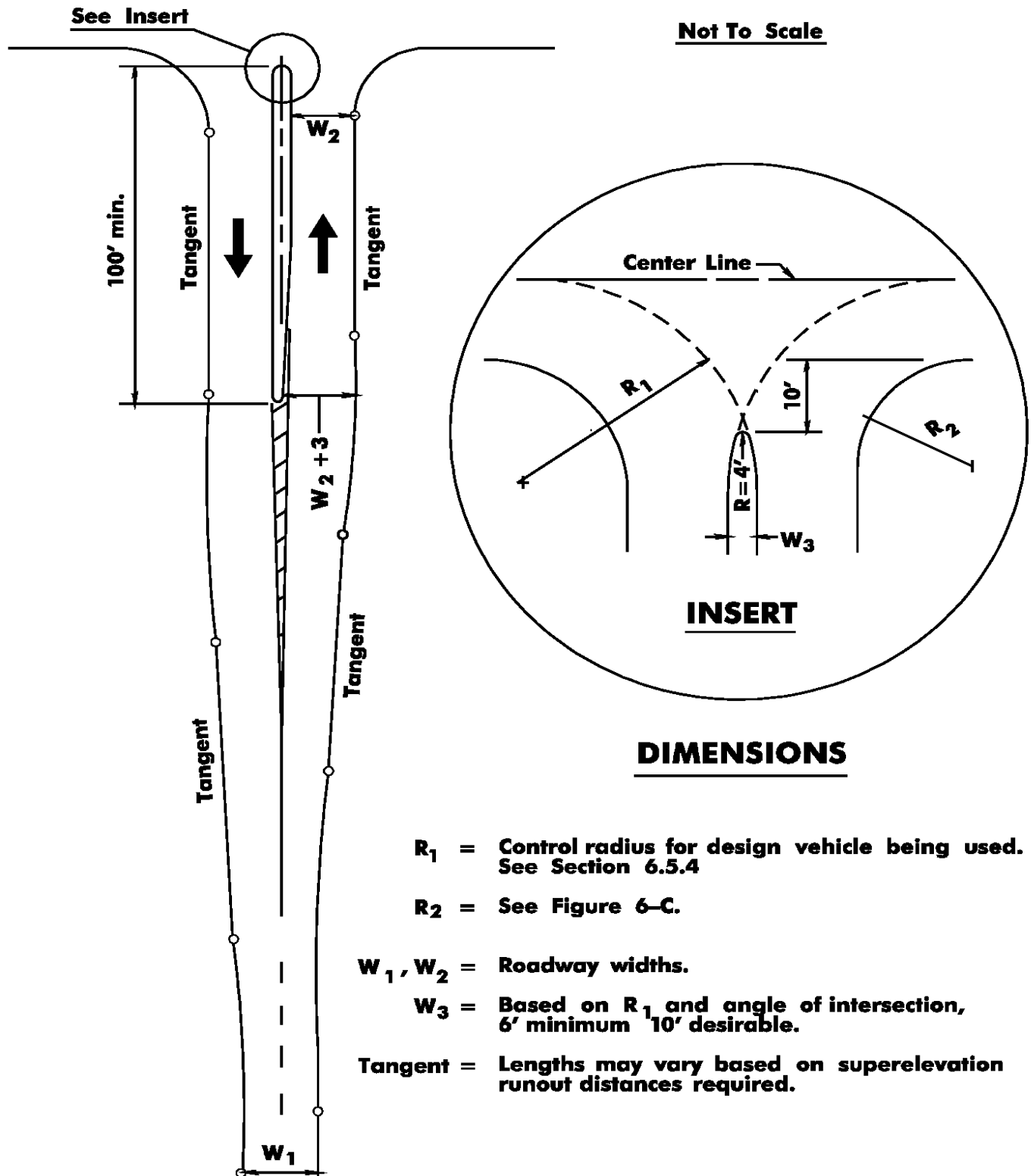

6.5.3 Auxiliary Lanes

Auxiliary lanes at intersections serve a wide range of purposes including space for deceleration and acceleration, bus stops, increased capacity through an intersection, and storage for turning vehicles. The width of the auxiliary lanes shall be in accordance with Section 5.3.

Deceleration lanes are always advantageous, particularly on high speed roads, because the driver of a vehicle leaving the highway has no choice but to slow down on the through-traffic lane if a deceleration lane is not provided. On the other hand, acceleration lanes are not always necessary at stop controlled intersections where entering drivers can wait for an opportunity to merge without disrupting through traffic. Acceleration lanes are advantageous on roads with yield control and on all high volume roads even with stop control where openings between vehicles in the peak-hour traffic streams are infrequent and short.

When practical, an acceleration or deceleration lane should be of sufficient width and length to enable a driver to maneuver a vehicle onto it properly and once onto it, to make the necessary change between the speed of operation on the highway or street and the lower speed on the turning roadway. See Figure 6-H for desirable lengths of acceleration and deceleration lanes.

The capacity of a signalized intersection may be increased by adding an auxiliary lane to accommodate through traffic. The introduction of the auxiliary lane can usually be accomplished easily since it is effectively metered into the auxiliary lane. The merging of traffic from the auxiliary lane back into the through lane beyond the signal requires the auxiliary lane to be carried a distance beyond the stop line at the traffic signal to a point where the merging taper is introduced. The minimum length of the auxiliary lane in advance of and beyond the intersection including tapers shall be in accordance with Figure 6-G. The Bureau of Traffic Signal and Safety Engineering must approve the addition of an auxiliary lane to improve capacity at signalized intersections.

AUXILIARY LANE ADDITIONS AT SIGNALIZED INTERSECTIONS

FIGURE: 6-G

BDC07MR-05

LENGTH OF ADDITIONAL WIDENING IN ADVANCE OF INTERSECTION

L_1 = Length of auxiliary lane:

DESIGN SPEED (mph)	L_1 (Feet)
40 or less	315
45	375
50	435
55	485
60	570

LENGTH OF ADDITIONAL WIDENING BEYOND INTERSECTION

L_2 = Length of auxiliary lane equals the greater of:

DESIGN SPEED (mph)	L_2 (Feet)
40 or less	380
45	560
50	760
55	960
60	1170

OR

$L_2 = 12 \times \text{Minimum green time } G \text{ (sec.) for approach signal. If } G = 40, \text{ then } L_2 = 12 \times 40 \text{ sec} = 480'$

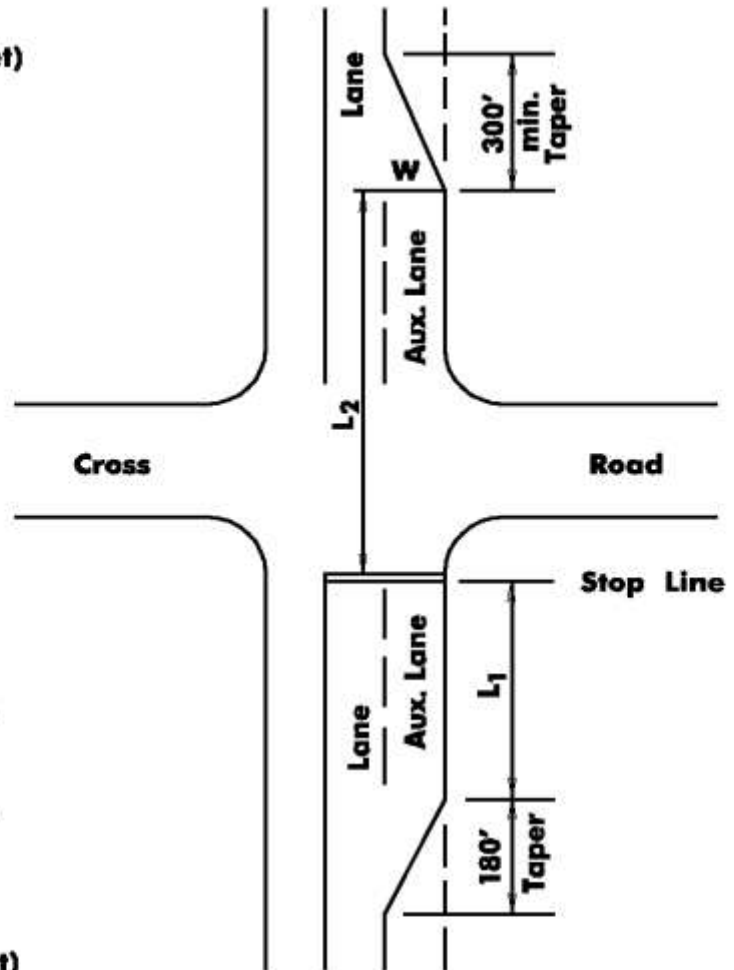

NOT TO SCALE

LAND SERVICE HIGHWAYS AUXILIARY LANE LENGTHS

FIGURE: 6-H
BDC07MR-05

LENGTH OF DECELERATION LANES

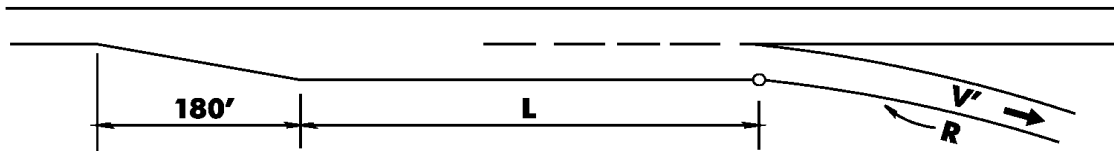

HIGHWAY DESIGN SPEED MPH (V)	L = LENGTH OF DECELERATION LANE - FEET								
	FOR DESIGN SPEED OF EXIT CURVE - MPH (V')								
	STOP CONDITION	15 50' R	20 90' R	25 150' R	30 230' R	35 340' R	40 485' R	45 660' R	50 850' R
	FOR AVERAGE RUNNING SPEED ON EXIT CURVE - MPH (V'a)								
	0	14	18	22	26	30	36	40	44
30	235	200	170	140	—	—	—	—	—
40	320	295	265	235	185	155	—	—	—
50	435	405	385	355	315	285	225	175	—
60	530	500	480	460	430	405	350	300	240
65	570	540	520	500	470	440	390	340	280
70	615	590	570	550	520	490	440	390	340

LENGTH OF ACCELERATION LANES

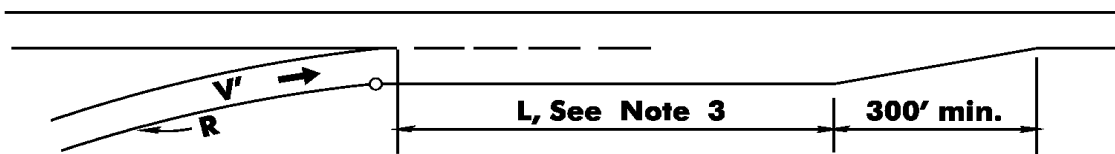

HIGHWAY DESIGN SPEED MPH (V)	L = LENGTH OF ACCELERATION LANE - FEET								
	FOR DESIGN SPEED OF ENTRANCE CURVE - MPH (V')								
	STOP CONDITION	15 50' R	20 90' R	25 150' R	30 230' R	35 340' R	40 485' R	45 660' R	50 850' R
	AND INITIAL SPEED - MPH (V'a)								
	0	14	18	22	26	30	36	40	44
30	180	140	—	—	—	—	—	—	—
40	360	300	270	210	120	—	—	—	—
50	720	660	610	550	450	350	130	—	—
60	1,200	1,140	1,100	1,020	910	800	550	420	180
70	1,620	1,560	1,520	1,420	1,350	1,230	1,000	820	580

- NOTES:**
- 1: Minimum radii shown are for intersection curves. For design speeds of more than 40 mph, use values for open highway curves.
 - 2: These tables apply to flat grades of 2% or less. For grades steeper than 2%, use the adjustments for grade in table Exhibit 10-71 of the source shown below.
 - 3: "L" may start back on the curvature of the ramp where the entrance radius is equal to or greater than 1,000 feet and the motorist on the ramp has an unobstructed view of traffic on the through lanes to his left.

Source: A Policy on Geometric Design of Highways and Streets.

6.5.4 Median Openings

Median openings on divided roadways are provided to permit intended movements only. Figures 6-I and 6-J show the application of grass median and concrete barrier curb median openings, respectively, to control the various types of movements along a divided roadway.

The length of the median opening desirably should equal the full roadway width of the cross road, shoulder to shoulder plus 10 feet on both sides to accommodate a crosswalk, except where the median extends into the sidewalk/crosswalk area as described below. The control radius (R1) should also be considered in determining the minimum length of median opening. The control radius (R1) is determined by the design vehicle as follows:

<u>Design Vehicle</u>	<u>Control Radius</u>
P and SU	40 feet
SU, BUS, WB-40	50 feet
WB-40, WB-50	75 feet

Where possible, medians that are at least 6 feet wide may be designed to provide a safe refuge location for pedestrians. At signalized intersections, where medians are used as a pedestrian refuge, pedestrian push buttons should be used in the median where signal timing does not allow sufficient time for pedestrians to cross the entire roadway in one cycle. Barrier curb medians should not be used as a refuge for pedestrians.

The use of a 40 feet minimum length of opening without regard to the width of median, the cross road width, pedestrian traffic or the control radius should not be considered. The 40 feet minimum length of opening does not apply to openings for U-turns except at very minor crossroads. Consult *A Policy on Geometric Design of Highways and Streets*, AASHTO, current edition, for the design of U-turn median openings.

On urban divided roadways, median openings for U-turns should not be provided. U-turn movements may be permitted at signalized intersections where there is sufficient pavement width to accommodate the movement. Provisions for U-turns should be made on rural divided roadways where intersections are spaced in excess of one half mile apart. Median widths in such cases should be at least 20 feet and desirably 30 feet to provide adequate protection for the vehicle executing the U-turn movement from the median. It is highly desirable to construct a median left-turn lane in advance of the U-turn opening to eliminate stopping on the through lanes.

GRASS MEDIAN OPENING

FIGURE: 6-1
BDC07MR-05

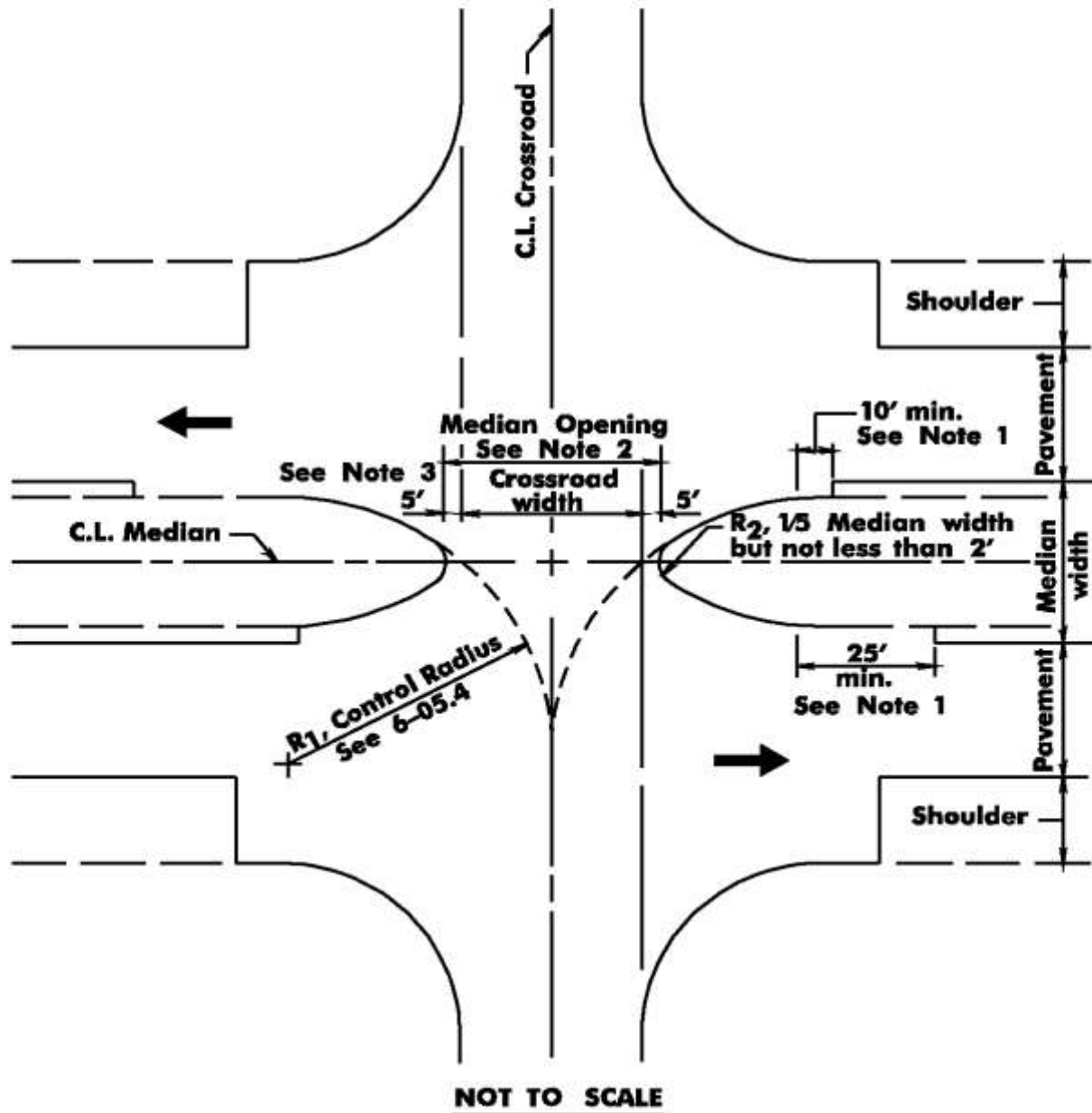

- NOTE 1:** Where lane and shoulder pavement are different, use the minimum offsets shown above.
- NOTE 2:** In no case shall the length of the median opening be less than 40 feet.
- NOTE 3:** Provide 10 feet where there is a marked or unmarked pedestrian crosswalk. As an alternate, provide median cut through for pedestrian traffic.

NEW LOCATIONS OF CONCRETE BARRIER CURB AT MEDIAN OPENING

FIGURE: 6-J
BDC07MR-05

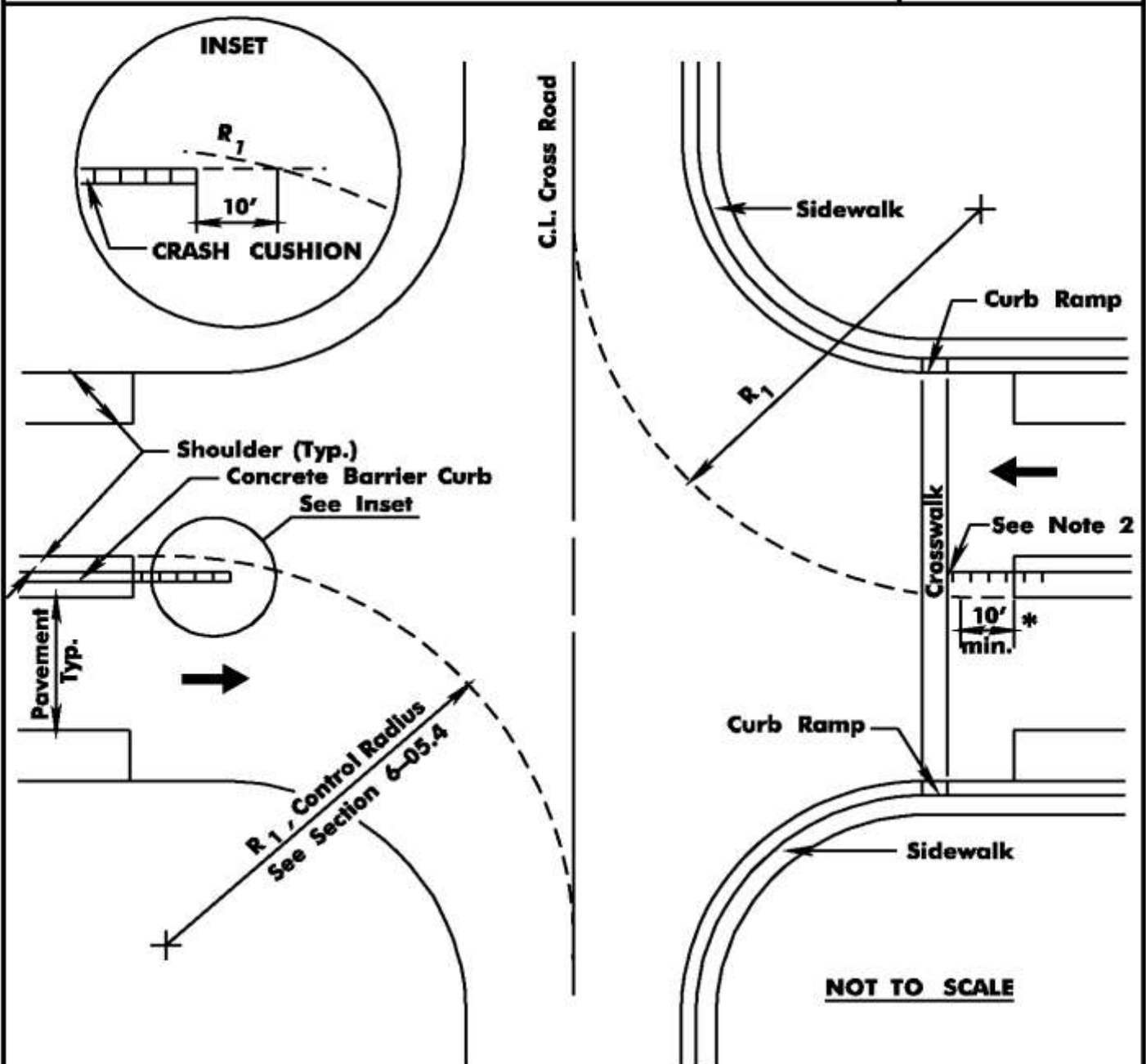

- NOTES**
- 1: Use control radius to set the location of the **CRASH CUSHION**.
 - 2: Adjust the location of the **CRASH CUSHION** so it does not interfere with marked or unmarked crosswalks.
 - * 3: Where lane and shoulder pavement are different, use the minimum offset shown above to set beginning of inside shoulder.
 - 4: Use a **CRASH CUSHION** where posted speed is greater than 40 mph.
 - 5: See Section 8 for discussion of end treatments for concrete barrier curb.

6.5.5 Median Openings for Emergency Vehicles

Although it is desirable to require all U-turns by official vehicles to be accomplished at intersections or interchanges, experience demonstrates that some emergency median openings are necessary for proper law enforcement, fire-fighting apparatus, ambulances and maintenance activities. Where median openings are provided for use by official vehicles only, they shall be limited in number and carefully located in accordance with this section and the needs of local authorities.

On freeways and Interstate highways where the spacing of interchanges is greater than approximately 3 miles, a U-turn median opening may be provided at a favorable location halfway between the interchanges. Where the spacing of interchanges is greater than about 6 miles, U-turn median openings may be provided so that the distance between such openings or interchange is not greater than about 3 miles.

In general, U-turn median openings should not be provided on urban freeways due to the close spacing of interchanges. Due to the close proximity of intersections on divided arterials, emergency U-turn median openings are not normally provided. However when emergency facilities are located between intersections, there may be a need for direct access to the highway.

See Figures 6-K & 6-L for typical emergency median opening treatments.

EMERGENCY MEDIAN OPENINGS ON LAND-SERVICE ROADWAYS

FIGURE: 6-K
BCD07MR-05

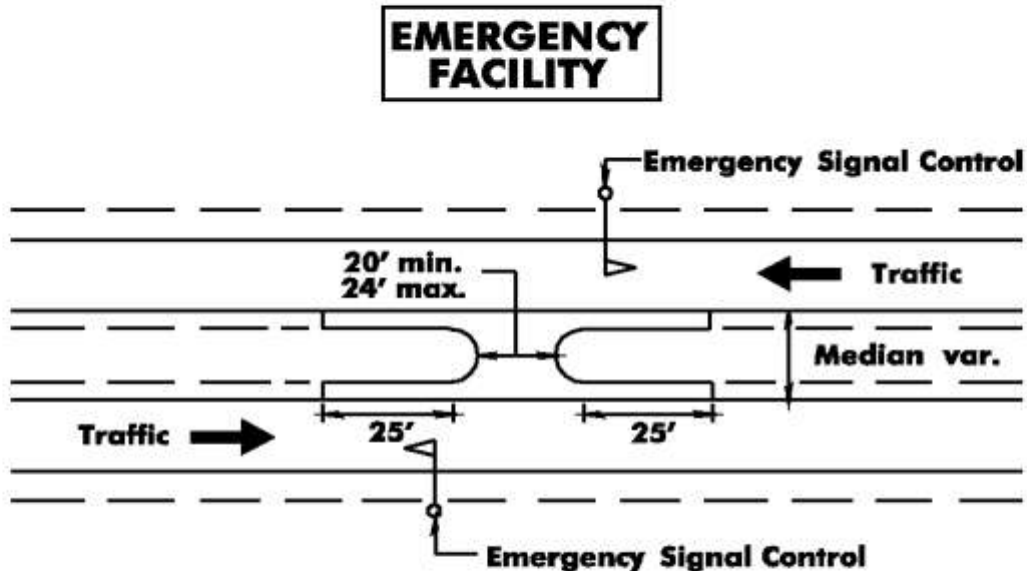

- NOTE**
1. Grading to be done at 8% around median opening.
 2. If necessary, ponding water is to be eliminated by providing an "E" inlet in the median C.L. and connecting to existing drainage line.
 3. Adequate stopping sight distance must be available.

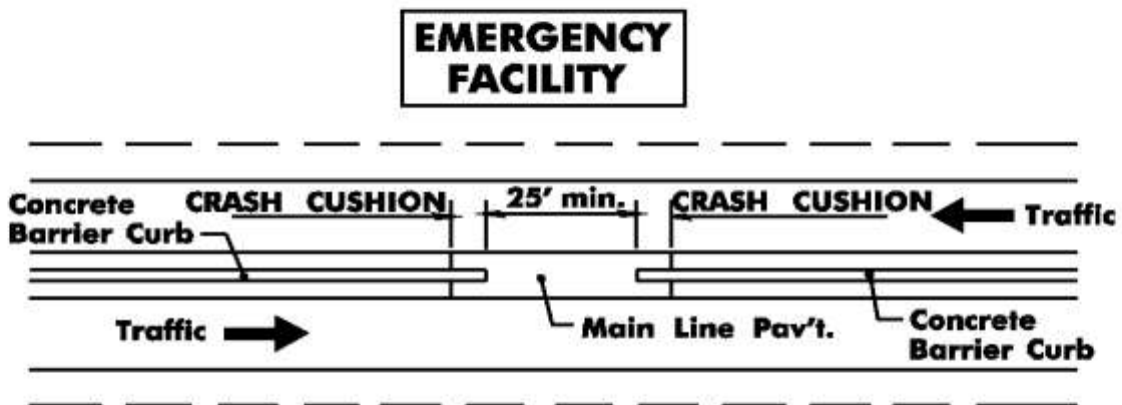

- NOTE**
1. Emergency signal control may be placed in concrete barrier curb, or outside the shoulder area as shown above.
 2. Adequate stopping sight distance must be available.
 3. As an alternative to using a CRASH CUSHION, a remote controlled "Barrier Gate" may be used to provide a 26' or 40' opening in concrete barrier curb during emergency response times.

EMERGENCY MEDIAN OPENINGS ON FREEWAYS OR INTERSTATE HIGHWAYS

FIGURE: 6-L
BDC07MR-05

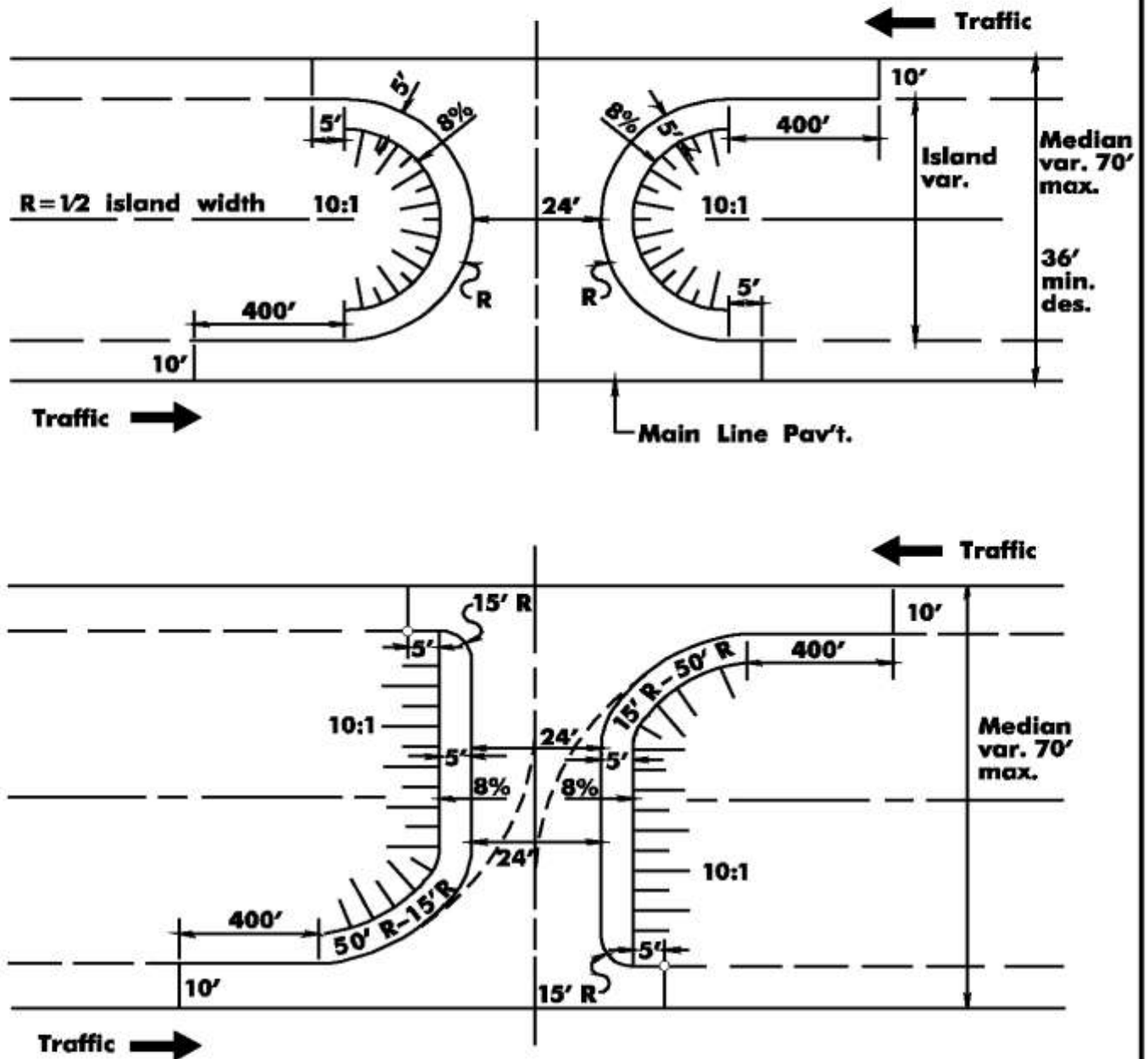

- NOTES:**
1. Ponding of runoff is to be eliminated by conventional means.
 2. The median opening is to be located where adequate stopping sight distance may be provided.
 3. The median opening should be located $\frac{1}{2}$ mile from any freeway underpass and at least one mile from any ramp terminal.

6.6 Median Left-Turn Lane

6.6.1 General

A median lane is provided at an intersection as a deceleration and storage lane for vehicles turning left to leave the highway. Median lanes may be provided at intersections and other median openings where there is a high volume of left-turns, or where vehicular speeds are high on the main roadway. Median lanes may be operated with traffic signal control, with stop signs, or without either, as traffic conditions warrant. Figure 6-M shows a typical median left-turn lane.

6.6.2 Lane Width

Left-turn lanes with median curbing should be 11 feet wide and desirably 14 feet wide. The lane width is measured from the curb face to the edge of through lane. Left-turn lanes without median curbing should be at least 11 feet wide and preferably 12 feet wide.

Median widths of 20 feet to 25 feet or more are desirable at intersections with a single left-turn lane, but widths of 15 feet to 18 feet are acceptable.

6.6.3 Length

The total length of the left-turn lane is the sum of storage length and entering taper.

- **Storage Length**

The median left-turn lane should be sufficiently long to store the number of vehicles likely to accumulate during a critical period. The storage length should be liberal to avoid the possibility of left-turn vehicles stopping in the through lanes (see Figure 6-M).

- **Taper**

The entering taper treatment is illustrated in Figure 6-M.

TYPICAL LEFT-TURN SLOT

FIGURE: 6-M

BDC07MR-05

NOT TO SCALE

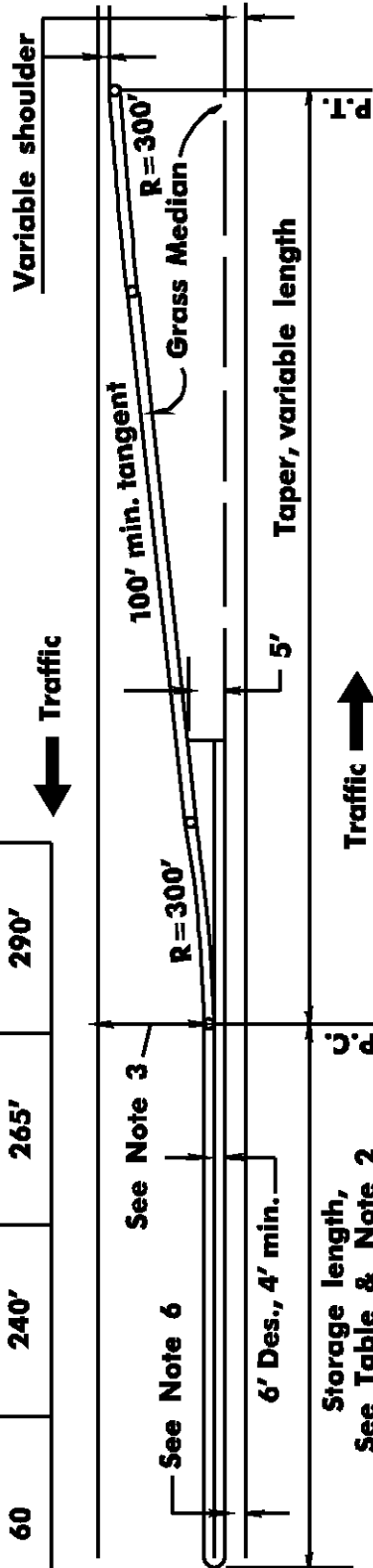

Design Speed (mph)	Storage Length	Taper Length	
		11' Lane	12' Lane
30	100'	130'	145'
40	125'	175'	190'
50	195'	220'	240'
60	240'	265'	290'

DESIGN GUIDELINES

1. Maximum verticle curb size: 9" x 16" or use sloping curb.
2. Increase storage length, shown in table, 100 feet for each 100 DHV (turning vehicles) at unsignalized intersections. For signalized intersections check storage length with the Bureau of Traffic Signals and Safety.
3. Left-turn lane width:
Curbed: 14 feet desirable, 11 feet minimum.
Painted: Desirably same width as adjacent traveled lane, minimum 11 feet. It may be reduced to 10 feet on projects where the posted speed is 40 mph or less.
4. For painted left-turn lanes, a minimum 60 foot taper may be provided.
5. Consult Traffic Signal and Safety Unit (TSSE) for the design of Left-turn lanes adjacent to barrier curb.
6. Where there is a continuous median with shoulders, the offset shall be the same as the approach shoulder. Where there is no continuous median with shoulder, provide a 3 foot minimum offset.

6.7 Continuous Two-Way Left-Turn Median Lane

6.7.1 General

A continuous two-way left-turn median lane provides a common space for speed changes and storage for left-turn vehicles traveling in either direction and allows turning movements at any location along a two-way roadway.

Continuous two-way left-turn median lanes are an effective means of providing an increased level of service on many urban arterials. They are especially effective in locations of strip commercial development and frequent driveway openings experiencing moderate left-turn demands.

Since it is possible for vehicles traveling in opposite directions to enter the two-way left-turn lane simultaneously, sufficient stopping sight distance must be provided to permit vehicles to stop. Table 6-1 provides the desirable stopping sight distance as related to design speeds that are applicable to two-way left-turn lanes.

**Table 6-1
Desirable Stopping Sight Distances for
Two-Way Left-Turn Lanes**

Design Speed (mph)	Stopping Sight Distance (feet)
30	400
35	500
40	610
45	720
50	850
55	990
60	1140

The length of crest vertical curve can be computed by the following formulas. The formulas are based on the height of the driver's eyes of 3.5 feet and of an object 2 feet on the road, which is equivalent to the headlight height above the roadway.

When S is greater than L, $L=2S-(2158/A)$

When S is less than L, $L=AS^2/2158$

S= Stopping sight distance from Table 6-1, in feet.

L= Length of vertical curve, in feet.

A= Algebraic difference in grade, in percent.

If there is adequate roadway lighting present, the object height may be increased to 4.25 feet (top of vehicle), therefore, substitute "3093" for "2158" in the previous formulas. The vertical curve length on the highway should also be checked by Figure 4-I and use the greater of the two "L" values when designing the vertical curve.

Figure 6-N shows a typical two-way left-turn median lane.

6.7.2 Lane Width

Lane widths for continuous two-way left turn median lanes range from 12 feet to 16 feet. The wider pavement width should be used only when raised islands are provided at major intersections with high left-turn demands. A median lane width of 12 feet is desirable where raised islands are not provided at major intersections.

6.7.3 Cross Slope

Generally the crown line should be located in the center of the median turn lane. The slope of pavement from the crown line should be the same as the cross slope on the through lane adjacent to the median lane.

TWO-WAY LEFT-TURN LANE

FIGURE: 6-N

BDC07MR-05

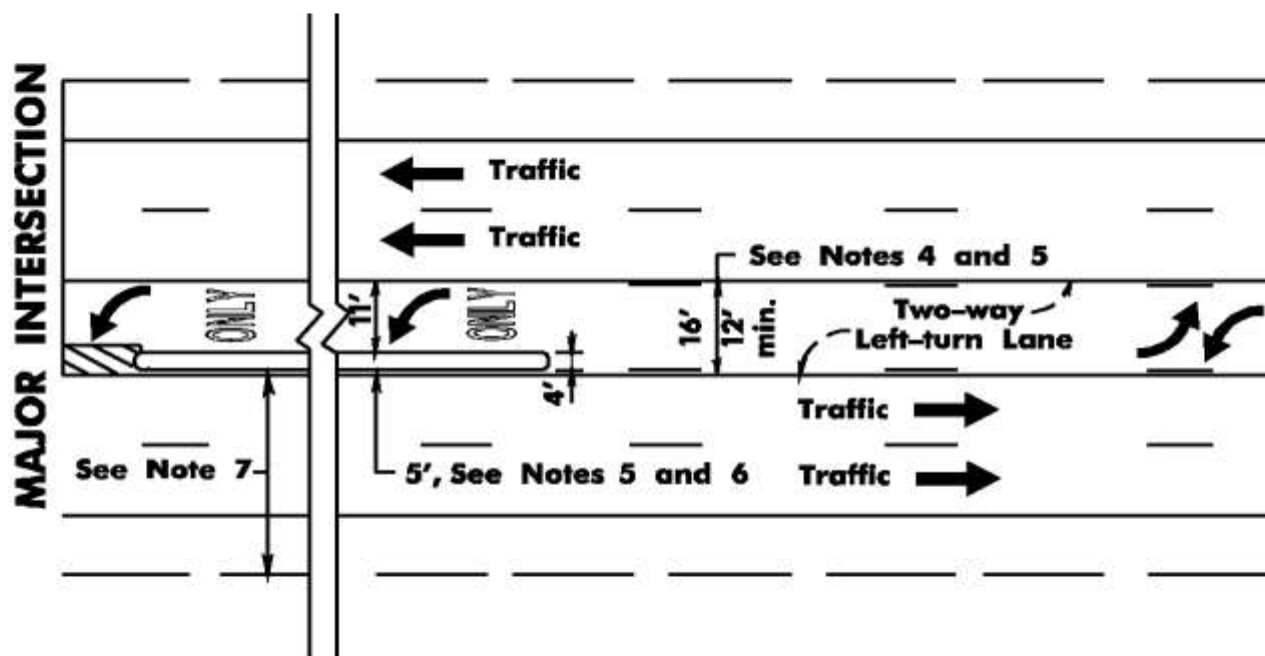

DESIGN GUIDELINES

1. For desirable & minimum stopping sight distance requirements, See Table 6-1.
2. For proper signing and paint striping consult the "Manual On Uniform Traffic Control Devices".
3. Two-way left-turn lanes are not recommended where the number of thru lanes exceeds two lanes in each direction.
4. Divisional Island used only when median width is at least 16 feet wide.
5. Where the design speed is equal to or greater than 50 mph, the recommended paint line offset to divisional island is two feet, which would increase the two-way left-turn lane width by one foot.
6. Divisional Island with a crosswalk opening used as a pedestrian refuge should be 6 feet wide.
7. Where there is only one through lane the minimum width shall be 20 feet (where there is a curbed island).

6.8 Jughandles

6.8.1 General

A "jughandle" is an at-grade ramp provided at or between intersections to permit the motorists to make indirect left turns and/or U-turns. Around-the-block designs that use interconnecting local street patterns to accomplish indirect left turns or U-turns are not considered "jughandles".

These ramps exit from the right lane of the highway in advance of the intersection, or past the intersection and convey traffic across the main highway under traffic signal control. This movement eliminates all turns within active traffic lanes and, in addition to providing greater safety, reduces delays to the through traffic that left turning vehicles usually create.

6.8.2 Ramp Width

Ramp widths are based on Figure 7-B. The minimum width for a one lane ramp should not be less than 22 feet. Ramps may have more than one lane when greater traffic volumes are anticipated.

6.8.3 Access Control

In order to provide safe and efficient traffic operations on land service highways, the interior of all jughandles shall be acquired. In addition, no access is permitted on the outside of all jughandles including the entire length of acceleration and deceleration lanes, excluding the taper length, see Figures 6-O, 6-P, and 6-Q. It is desirable that no access is permitted along the taper length of acceleration and deceleration lanes.

When a deceleration lane extends through an intersection and the deceleration lane accommodates both the right turn move onto the cross street and the right turn onto the jughandle past the intersection; the access restriction that applies in advance of the intersection is "corner clearance", see Figure 6-Q. The deceleration lane following the intersection has no access permitted in accordance with the prior paragraph.

Where access is proposed at new or existing jughandle locations, design waivers (submitted as an attachment to the permit application) to the above paragraph will be granted only after a thorough analysis has been made with respect to the cost of acquisition and impact on safety. For further information on access control, see Section 5.8, "Driveways".

The designer should also reference the *NJ State Highway Management Code* for further information.

6.8.4 Standard Jughandle Designs

Figures 6-O through 6-Q illustrate the basic jughandle configurations. The dimensions and radii shown are recommended, however, social, environmental or economic impacts may make adherence to the basic geometrics impractical. The recommended design speeds for the basic jughandle configurations are shown in Table 6-2. Pedestrian and bicycle accommodations should be added at all proposed jughandles and should be added at existing jughandles whenever feasible.

**Table 6-2
Jughandle Design Speeds**

Jughandle Type	Minimum Design Speed (mph)
A	25
B - one lane	15
B - one lane with T Intersection	20
B - two lane	25
C - loop ramp	15 (20 des.)
C - finger ramp	25

When initially providing jughandles at locations where there are no existing cross streets or there is an intersecting street on only one side, the designer should evaluate the future development potential of the property adjacent to the jughandle. Consideration should be given to designing the jughandle for future expansion to accommodate the access needs of the adjacent property.

The design of Type "B" jughandles should generally be limited to locations where the development of the adjacent land is limited due to topography, environmental constraints, zoning restrictions, etc.

6.8.5 Superelevation and Cross Slope

It is desirable to provide as much superelevation as practical on jughandles, particularly where the ramp curve is sharp and on a downgrade. Table 6-3 provides a suggested range of superelevation rates in percent for various ramp radii. Rates in the upper half or third of the indicated range are preferred. The cross slope on tangent sections of ramps are normally sloped one-way at 2 percent, which is considered a practical minimum for effective drainage across the surface (see Figure 5-J).

**Table 6-3
Jughandle (Ramp) Superelevation (%)**

Design Speed mph	Radius (feet)					
	50	90	150	230	310	430
	Superelevation (%)					
15	2-6	2-6	2-5	2-4	2-3	2-3
20	---	2-6	2-6	2-6	2-4	2-3
25	---	---	4-6	3-6	3-6	3-5
30	---	---	---	6	5-6	4-6

Exceptions to the use of full superelevation are at street intersections where a stop or yield condition is in effect.

The length of superelevation transition should be based on Section 4.3.2.2. With respect to the beginning and ending of a curve on the ramp proper (not including terminals), see Table 4-4 for the portion of the runoff located prior to the curve. This may be altered as required to adjust for flat spots or unsightly sags and humps when alignment is tight. The principal criteria is the development of a smooth-edge profile that does not appear distorted to the driver.

See Section 7.6.2, "Ramp Terminals," for a discussion on development of superelevation at free-flow ramp terminals and the maximum algebraic difference in cross slope at crossover line.

6.8.6 Crosswalks, Pavement Markings and Bike Lanes

Where pedestrian volumes warrant, crosswalk pavement should be placed at the desired crossing location. Supplemental warning signs and lighting may be provided.

Bike lanes may continue through the jughandle if cyclists can be expected to use the jughandle to make a turn (for example, to connect to another bike lane).

Crosswalks, pavement markings and bike lanes should be designed as per the MUTCD.

When crosswalk striping is deemed necessary, design traffic signal and stop sign controlled intersections using standard parallel lines - 6 feet apart. The enhanced diagonal or longitudinal crosshatching is reserved for more atypical, unexpected pedestrian crossing locations, as per MUTCD Section 3B.17.

TYPICAL TYPE "A" JUGHANDLE

FIGURE: 6-O

BDC07MR-05

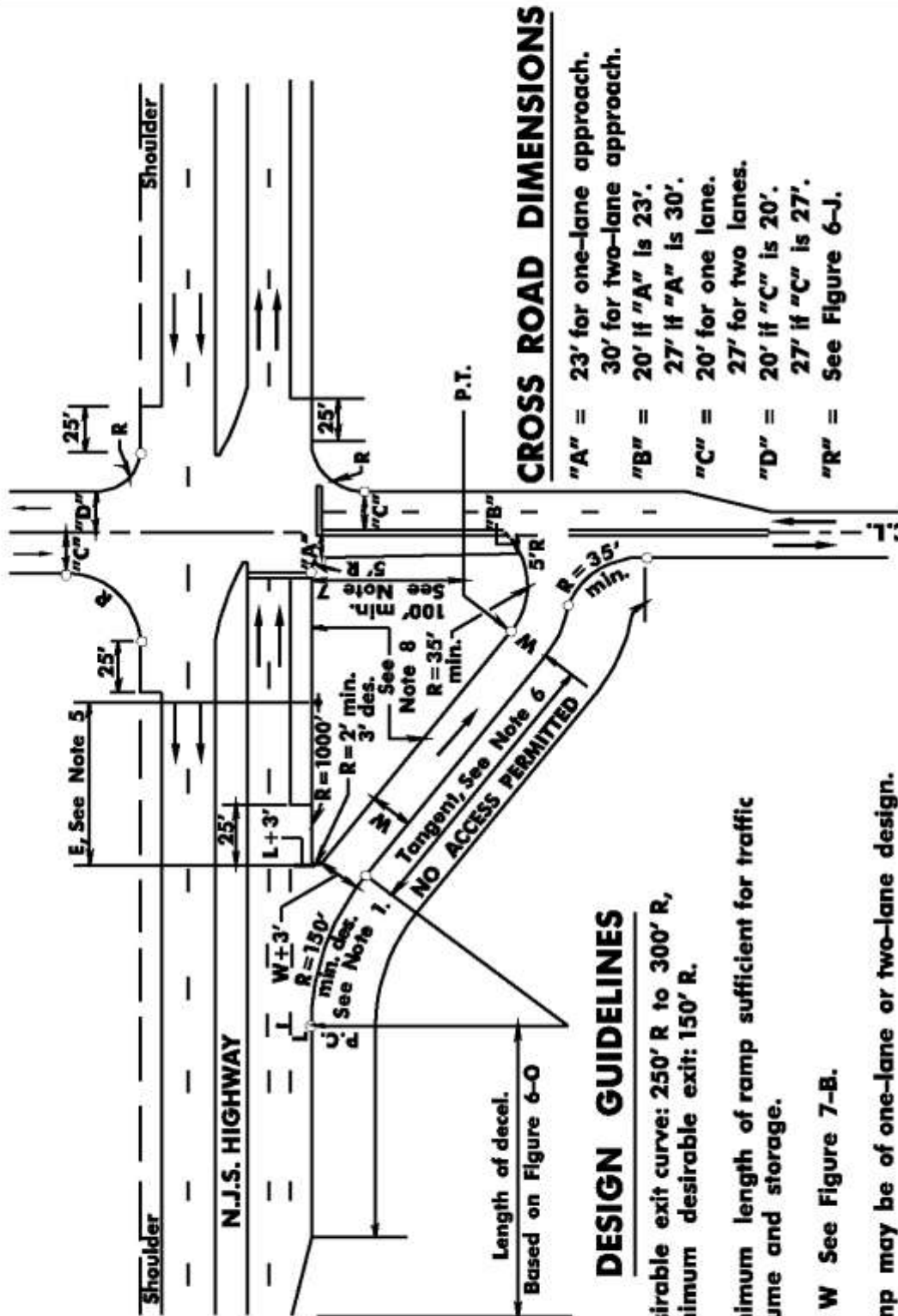

CROSS ROAD DIMENSIONS

- "A" = 23' for one-lane approach.
30' for two-lane approach.
- "B" = 20' if "A" is 23'.
- "C" = 20' for one lane.
27' for two lanes.
- "D" = 20' if "C" is 20'.
- "R" = 27' if "C" is 27'.
- "R" = See Figure 6-J.

DESIGN GUIDELINES

1. Desirable exit curve: 250' R to 300' R, minimum desirable exit: 150' R.
2. Minimum length of ramp sufficient for traffic volume and storage.
3. For W See Figure 7-B.
4. Ramp may be of one-lane or two-lane design.
5. For a longitudinal run of utility poles, E=50'. For a transverse run of utility poles or for a guy pole, E=one-half the distance between exit terminal and cross road inside curbline.
6. Tangent length will be as required for superelevation transition.
7. Length should be sufficient to store vehicles waiting at signal.
8. Infield area may be used as retention or detention basins, but the design water surface elevation should be located outside the clear zone.

TYPICAL TYPE "B" JUGHANDLE

FIGURE: 6-P

BDC07MR-05

NOT TO SCALE

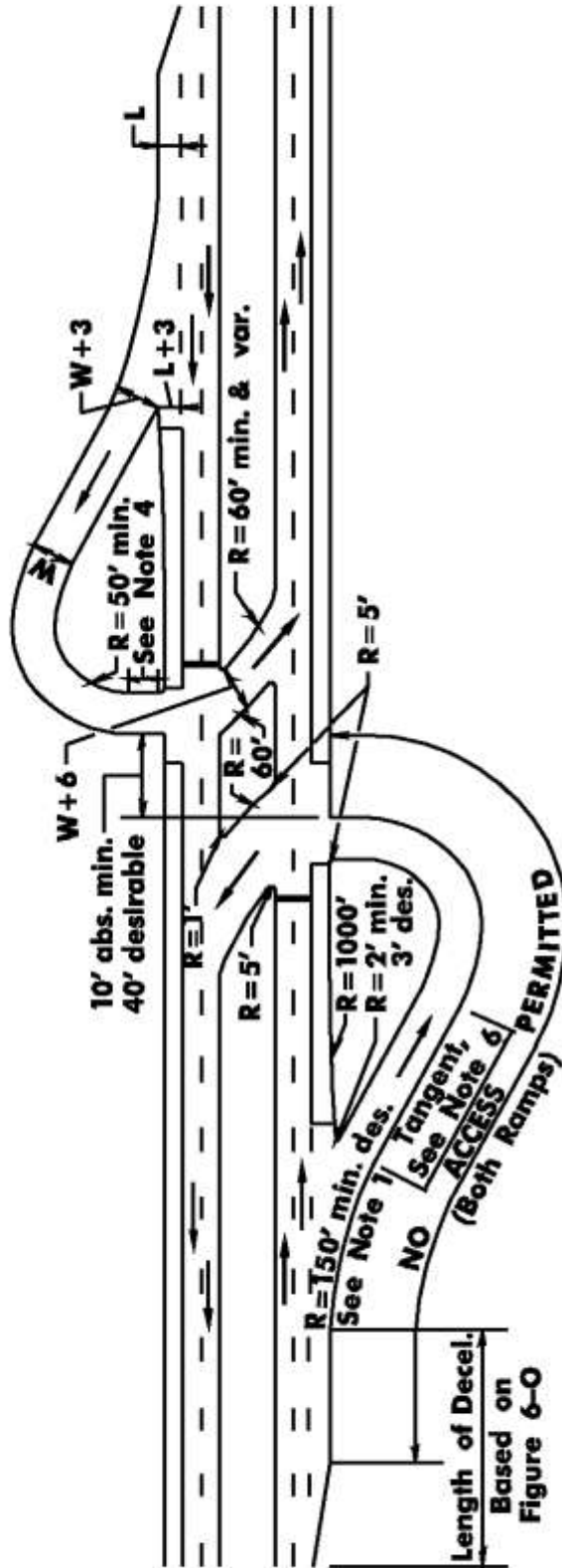

DESIGN GUIDELINES

1. Desirable exit curve: 250' R to 300' R., minimum desirable exit curve: 150' R.
2. Minimum length of ramp sufficient for traffic volume and storage.
3. See Note 5, Figure 6-U.
4. Tangent distance: 25' absolute minimum, 100' desirable.
5. Ramp may be of one-lane or two-lane design.
6. Tangent length will be as required for superelevation transition.
7. For W, See Figure 7-B.
8. The 50' minimum radius is for low volume one-lane U-turns. Where the jughandle is used to provide one-lane access to a T-intersection, it should have a minimum radius of 90'. If a two-lane jughandle is to be provided, a 150' minimum radius shall be used.
9. Infield areas may be used as retention or detention basins, but the design water surface elevation should be located outside the clear zone.

TYPICAL TYPE "C" JUGHANDLE

FIGURE: 6-Q

BDC07MR-05

DESIGN GUIDELINES

1. Desirable exit curve: $250' R$ to $300' R$.
Minimum desirable exit curve: $150' R$.
2. Tangent length will be as required for superelevation transition.
3. For W & W_1 See Figure 7-B.
4. See Notes 2 & 5, Figure 6-V.
5. Similar design ramp and/or ramps may be provided in any quadrant, as directed by traffic volume distribution.
6. See Note 8, Figure 6-V.
7. For a longitudinal run of utility poles, $D=50'$.
For a transverse run of utility poles or for a guy pole, D =one-half the distance between exit to entrance terminals.

Length of Accel.
Based on Figure 6-O

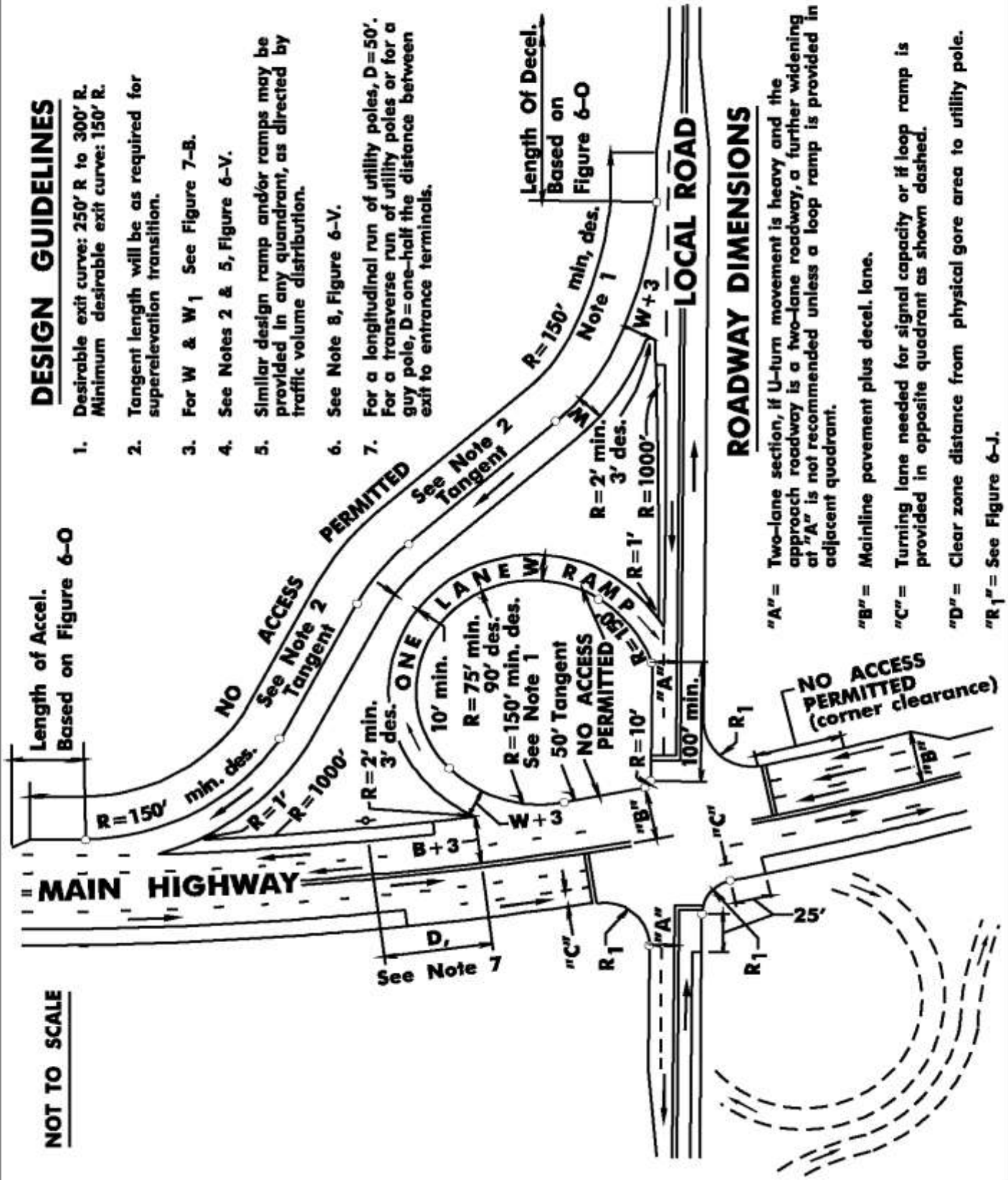

ROADWAY DIMENSIONS

- "A" = Two-lane section, if U-turn movement is heavy and the approach roadway is a two-lane roadway, a further widening at "A" is not recommended unless a loop ramp is provided in adjacent quadrant.
- "B" = Mainline pavement plus decel. lane.
- "C" = Turning lane needed for signal capacity or if loop ramp is provided in opposite quadrant as shown dashed.
- "D" = Clear zone distance from physical gore area to utility pole.
- "R₁" = See Figure 6-J.

NOT TO SCALE

6.9 Other Considerations

6.9.1 Parking Restrictions at Intersections

Vehicular parking should not be permitted within the immediate limits of at-grade intersections; see Section 6.3, "Sight Distance," for sight distance requirements at intersections.

6.9.2 Lighting at Intersections

Lighting affects the safety of highway and street intersections and the ease and comfort of traffic operations. In urban and suburban areas where there are concentrations of pedestrians and roadside and intersection interferences, fixed-source lighting tends to reduce accidents. Whether or not rural at-grade intersections should be lighted depends on the planned geometrics and the turning traffic volumes involved. Intersections that generally do not require channelization are seldom lighted. However, for the benefit of non-local highway users, lighting at rural intersections is desirable to aid the driver in ascertaining sign messages during non-daylight period.

Intersections with channelization, particularly with multiple-road geometrics, should include lighting. Large channelized intersections especially need illumination because of the higher range of turning radii that are not within the lateral range of vehicular headlight beams. Vehicles approaching the intersection also must reduce speed. The indication of this need should be definite and visible at a distance from the intersection that may be beyond the range of headlights. Illumination of at-grade intersections with fixed-source lighting accomplishes this need.

See Section 11, "Highway Lighting Systems," for guidelines in the planning and design of roadway lighting systems.

6.10 Bus Turnouts

6.10.1 Introduction

To reduce conflicts on state highways between through traffic and buses stopped to receive and/or discharge passengers, bus turnouts may be provided on land service highways when the outside shoulders on the highway are less than 10 feet in width. Bus turnouts should be designed to accommodate adjacent pedestrian walking space. The designer shall in conjunction with the transit agency providing service along the highway determine the locations of the bus turnouts.

Bus turnouts are most appropriate along roadways with:

- Vehicle speeds greater than 40 mph
- Moderate to high vehicle volumes
- Bus layover locations
- Wheelchair boarding areas

See Section 5 for further information on pedestrian accommodations at transit stops.

6.10.2 Location Criteria

When it has been determined that bus turnouts are appropriate, the following criteria should be used to select the bus turnout location(s):

1. The location should principally facilitate pedestrian access to the bus and transfers between transit lines. For example, if a housing development is located on one corner of an intersection, the bus stop/pullout should be located on that corner, regardless of

- whether it is a near or far-side turnout. Where two bus lines cross then the stops should be located so that riders have to cross the fewest number of streets to transfer. Note that transfers may be heavier in one direction (peak) than the others
2. The location should be close to the points of origins and/or destinations of the transit rider. Locations convenient to park and ride facilities, intermodal transfer facilities and transfer facilities between bus service are desirable.
 3. The bus turnouts should be located where patrons may park and cross roadways legally and safely. Desirably bus turnouts should be located within 400 feet of an intersection or parking areas used by the bus patrons. Alternatives including review and possible modification of parking regulations may be considered.
 4. Access to and from the bus stop is convenient to well lit pedestrian crossings, crosswalks or signalized crosswalks.
 5. Desirably there should not be any driveways within the bus turnout. As a minimum, there shall be no driveways located within the bus stopping area. Driveways may be located within the acceleration and deceleration portion of the bus turnout including the taper. However, to minimize conflicts between the vehicles using the driveway and the bus, the bus stopping area should desirably be located on the far side of the driveway.
 6. The vertical and horizontal highway geometry meets current stopping sight distance criteria.
 7. There is sufficient right-of-way available, or its acquisition would not involve developed parcels or environmentally sensitive parcels.
 8. A bus turnout may be placed on the far side or near side of an intersection, or at mid-block. When placed at intersections, locating the bus turnout on the far side is preferred. Near side bus turnouts create conflict with right turning traffic, obscure pedestrian view of oncoming traffic and may obscure a driver's view of signs, traffic control devices and pedestrians. Mid-block turnouts may be provided when there is a need to service a major pedestrian traffic generator (i.e., shopping mall, school railroad station, hospital, etc.).
 9. The location of the bus turnouts conform to local ordinances.

6.10.3 Other Considerations

In addition to the location criteria noted in Section 6.10.2, the following features should be considered when selecting bus turnout locations:

1. Utility and signal poles - The relocation of utility poles could require the acquisition of additional right-of-way, and depending upon the type of service provided involve excessive relocation costs. The location of the bus turnouts at intersections could involve costly signal relocations and when placed on the near side of the intersection stopped buses could obscure the signals.
2. Drainage - To avoid splashing of bus riders turnouts should not be located at low points in the vertical alignment. Also, additional inlets may be necessary to limit the spread in the gutter to 3 feet. Grades should be checked to avoid ponding where pavement cross slope exceeds the longitudinal slope in the turnout.
3. Guide rail - Openings in guide rail located along the curblin may not be permitted due to inadequate length of need or the inability to provide the proper end treatment.

4. Signing - The location of the bus turnout could interfere with the visibility of regulatory, warning and/or directional signs. The relocation of existing signs and/or the installation of new signs including bus stop signs shall be coordinated with the Bureau of Traffic Signals and Safety.
5. Handicapped ramps - When the construction of a bus turnout impacts an existing handicapped ramp(s) at an intersection, the designer shall assess the entire intersection to determine if the remaining curb ramps will be compatible. (see section 5.7.4)
6. Curb - Curb shall be provided at all bus turnouts. The curb height shall conform to Section 5.6.
7. The pavement section for widening or reconstruction of shoulders for bus turnouts should be determined by Geotechnical Engineering.

6.10.4 Bus Turnout Design Criteria

Figure 6-R illustrates typical bus turnout designs for a far side and an alternate far side bus turnout. Figure 6-S illustrates a typical mid-block turnout.

The bus stopping areas shall be a minimum of 50 feet in length for each standard 40 feet bus and 70 feet for every 60 feet bus expected to use the bus turnout. When more than one bus is expected to use the turnout simultaneously, the length of the bus stopping area should be adjusted accordingly. Desirably the width of the bus stopping area including the acceleration and deceleration lanes should be 12 feet where it is not practical to provide the 12 feet width, a minimum width of 10 feet may be provided to reduce right-of-way or environmental impacts.

Bus turnouts generally consist of entrance and exit tapers, deceleration and acceleration lanes, and a bus stopping area. The length of the tapers and the deceleration and acceleration lanes vary depending on the posted speed of the highway. Table 6-4 provides the desirable lengths. The use of lengths less than those shown in Table 6-4 may cause delays to the transit service and adversely impact the traffic flow on the highway.

Table 6-4

Posted Speed (mph)	Length of Acceleration Lane (feet)	Length of Deceleration Lane (feet)	Length of Entrance and Exit Tapers (feet)
35	250	185	170
40	400	265	190
45	700	360	210
50	975	470	230
55	1400	595	250

Source: TCRP Report 19, Guidelines for the Location and Design of Bus Stops

As a minimum bus turnouts may be constructed without acceleration and deceleration lanes when it is not practical to provide the above lengths. However, the designer should attempt to provide as much acceleration and deceleration lane length as practical.

The taper lengths shown in the Table are desirable. Minimum entrance and exit tapers shown in Figure 6-R and 6-S may be provided when it is not practical to provide those shown in the Table. The minimum lengths of taper are applicable with or without acceleration or deceleration lanes.

The pavement cross slope in the bus turnout shall be one half ($\frac{1}{2}$) percent greater than the adjacent through lane. On superelevated roadway sections, the pavement cross slope shall be the same as the adjacent through lane. When conditions dictate maintaining drainage flow in the existing gutter, the bus turnout may be sloped toward the gutter line at 1.5 to 2.0 percent.

The width of the sidewalk in the bus loading area should be sized to provide a level of service for waiting passengers and other pedestrian traffic with a minimum width of 7 feet. See Section 5. Sidewalk should be provided where there is no existing sidewalk approaching the bus loading area.

TYPICAL BUS TURNOUTS

FIGURE: 6-R

BDC07MR-05

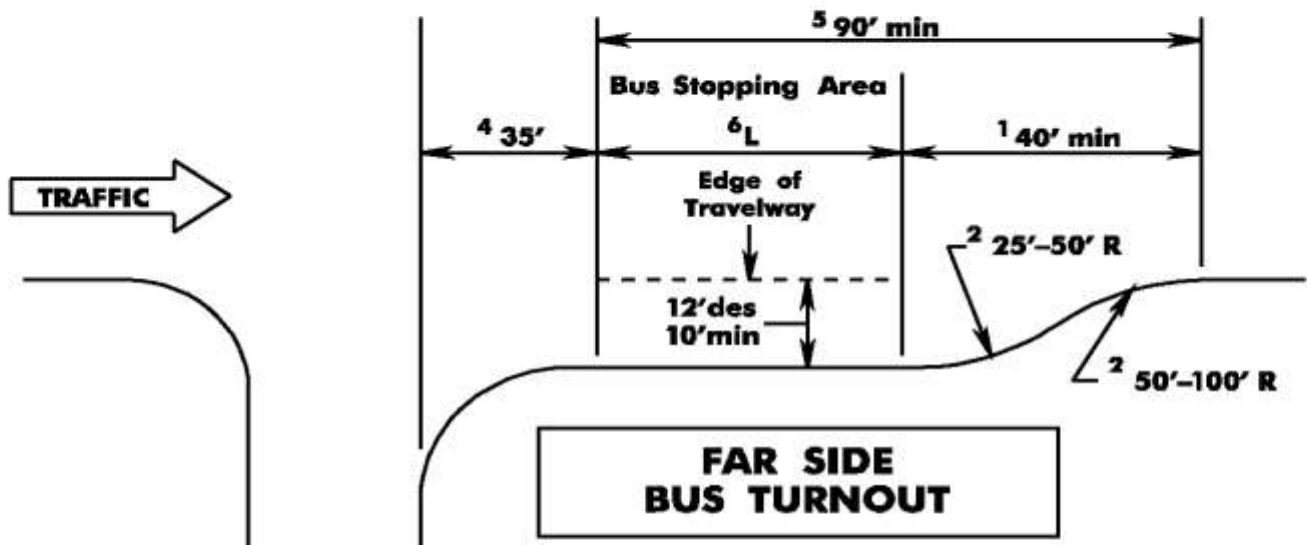

**FAR SIDE
BUS TURNOUT**

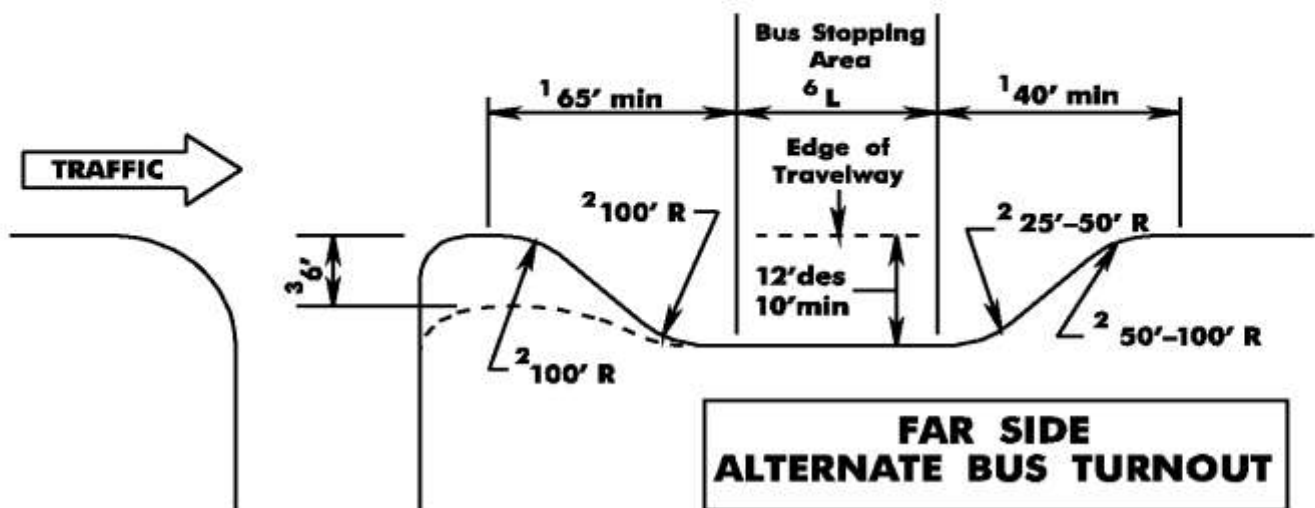

**FAR SIDE
ALTERNATE BUS TURNOUT**

- 1 Desirable taper and acceleration/deceleration lengths are shown in Table 6-4.
- 2 Use 300' R with 100' tangent separation when providing taper lengths.
- 3 A partial corner projection may be used in lieu of extending the curbline to the edge of the through lane.
- 4 NJSA 39:4.138e No stopping or standing within 25' of a crosswalk or side line of a street at least 35' from the curbline.
- 5 Bus turnout standards based on recommendations of the Institute of Traffic Engineering and Studies conducted by the Bureau of Traffic Engineering.
- 6 See Section 6-10.4 to determine minimum length (L) of bus stopping area.
- 7 NJSA 39:4-34 governs the pedestrian crossing location at intersections with streets and driveways.

TYPICAL BUS TURNOUTS

FIGURE: 6-S

BDC07MR-05

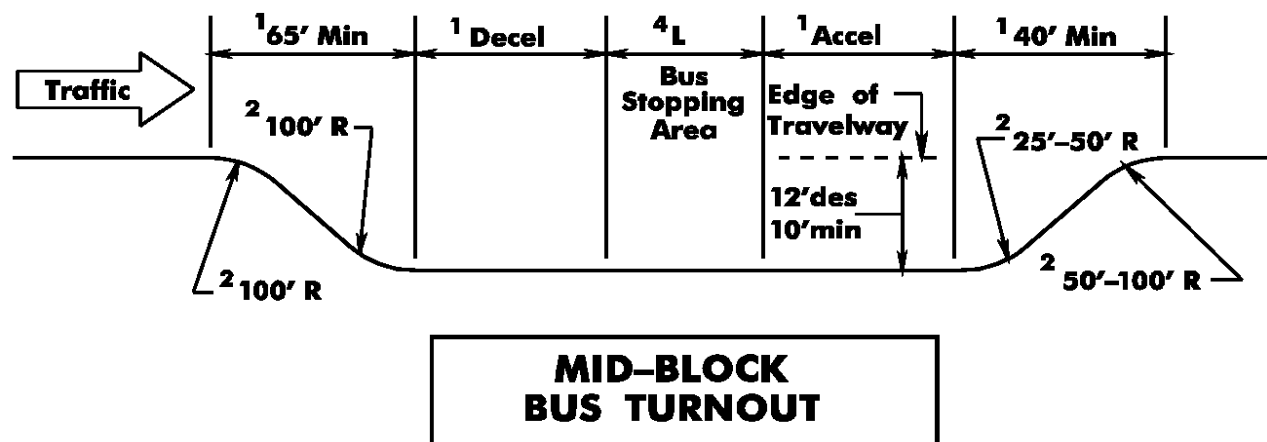
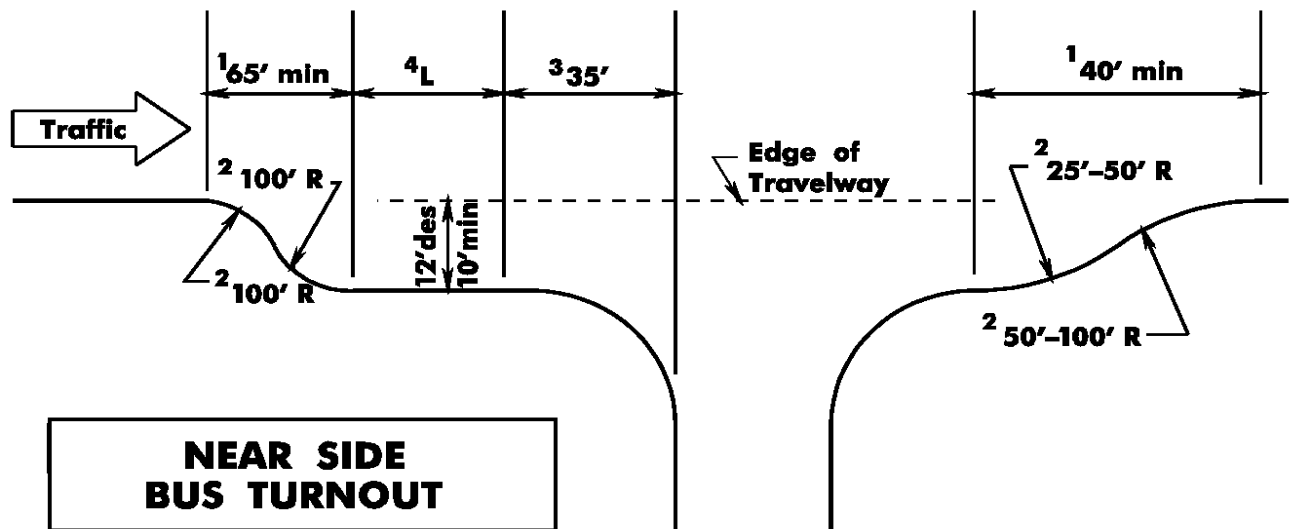

- 1 Desirable taper and acceleration/deceleration lengths are shown in Table 6-4
- 2 Use 300' with 100' tangent separation when providing taper lengths
- 3 NJSA 39:4.138e No stopping or standing within 25' of a crosswalk or side line of a street at least 35' from the curbline
- 4 See Section 6-10.4 to determine minimum length (L) of bus stopping area
- 5 NJSA 39:4-34 governs the pedestrian crossing location at intersections with streets and driveways

NOT TO SCALE