

ALLSTATE OFFICE INTERIORS



ALLSTATE
OFFICE INTERIORS

COVID 19 PPE SNEEZE GUARDS, SCREENS AND FURNITURE SOLUTIONS

Discount Structure Based on List Price

0-\$5,000 List - 34% Discount

\$5,001 to \$25,000 List - 42% Discount

\$25,001-\$100,000 List - 43% Discount

\$100,001-\$250,000 List - 44% Discount

\$250,001 - \$400,000 List - 45% Discount

\$400,001 + Negotiable

Prevailing Wage Rate \$160.00 per man hour

Non-Union Wage Rate \$66.00 per man hour

Truck Charge \$365.00 per day

No Charge for Travel Time

No Charge for Freight

Please make Purchase Orders out to:

Allstate Office Interiors

113 North Gold Drive

Robbinsville, NJ 08691

Attn: COVID Team

5/1/2020

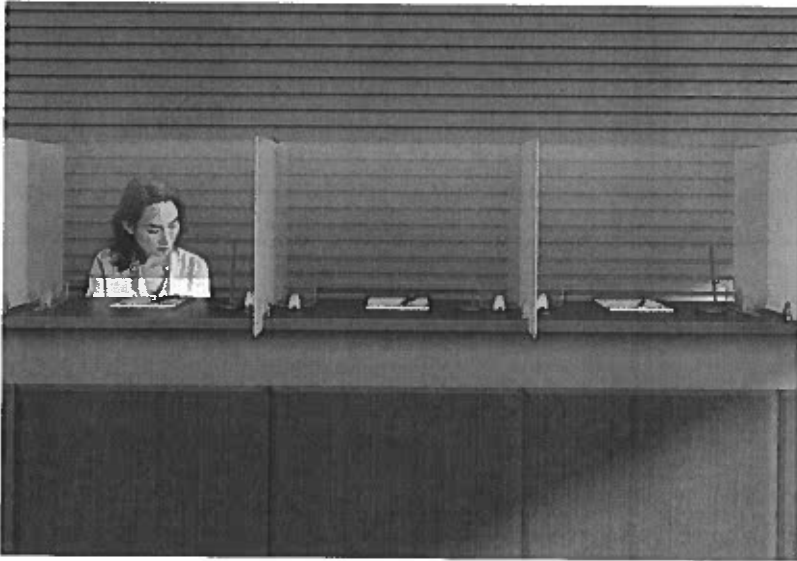

Protective Barrier Shields

Protect employees and customers with our high quality, professionally designed clear acrylic Sneeze Guard panels. Our see-through protective barriers have a smooth edged opening on the bottom for safe document and currency exchange and are available in a variety of widths and heights to shield your entire worksurface.

Sneeze guards can be mounted with free standing feet for a moveable solution or be permanently fixed to your countertop or worksurface. Easy to disinfect and clean, AOI Sneeze Guards are an effective solution to keep your work environment safe and virus-free.

- Panels are available in several widths and heights for maximum coverage
- Cutout is 4" high and extends the full width of the panel less than 6" from each side
- All acrylic edges are sanded for a smooth finish
- 1/4" thick Acrylic is easy to disinfect and clean
- Removable and permanent mounting options available
- Made in the USA
- Customization available – special materials, sizes, shapes and mounting options

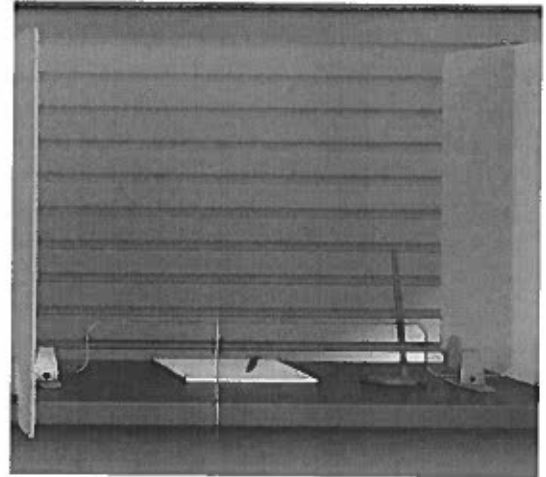

How to build your SKU:

Step 1: Model: **FADSG** — Step 2: Style: **CLR** — Step 3: Choose your Width: **42** — Step 3: Choose your Height: **30** — Step 4: Choose your Mounting Option: **SCEK**

FRAMELESS SNEEZE GUARD

Model	Style	Width	Height	Mounting			
FADSG	Frameless Sneeze Guard	CLR	Clear Acrylic	23"	24"	*TM	Top Mount (silver or black)
		FRO	Frosted Acrylic	30"	30"	*CEK	Edge Clamp - Knob (silver or black)
				36"	36"	SFS	Free Standing (silver)
				42"			
				47"			
				54"			
				60"			
				66"			
				72"			
				90"			



FRAMELESS SNEEZE GUARD
Style - Clear Acrylic
(CLR)

MOUNTING OPTIONS

			FADSG-CLR					
Width	Height	Weight (lbs)	Base Price	Top Mount	Price	Edge Clamp Knob	Free Standing	Price
23"	24"	10	\$190	* TM2	+\$38	* CEK2	SFS2	+\$66
23"	30"	12	\$235	* TM2	+\$38	* CEK2	SFS2	+\$66
23"	36"	14	\$320	* TM2	+\$38	* CEK2	SFS2	+\$66
30"	24"	12	\$235	* TM2	+\$38	* CEK2	SFS2	+\$66
30"	30"	14	\$400	* TM2	+\$38	* CEK2	SFS2	+\$66
30"	36"	16	\$405	* TM2	+\$38	* CEK2	SFS2	+\$66
36"	24"	13	\$320	* TM2	+\$38	* CEK2	SFS2	+\$66
36"	30"	16	\$405	* TM2	+\$38	* CEK2	SFS2	+\$66
36"	36"	18	\$570	* TM2	+\$38	* CEK2	SFS2	+\$66
42"	24"	14	\$325	* TM2	+\$38	* CEK2	SFS2	+\$66
42"	30"	17	\$415	* TM2	+\$38	* CEK2	SFS2	+\$66
42"	36"	20	\$580	* TM2	+\$38	* CEK2	SFS2	+\$66
47"	24"	16	\$335	* TM2	+\$38	* CEK2	SFS2	+\$66
47"	30"	19	\$420	* TM2	+\$38	* CEK2	SFS2	+\$66
47"	36"	22	\$590	* TM2	+\$38	* CEK2	SFS2	+\$66
54"	24"	18	\$570	* TM2	+\$38	* CEK2	SFS2	+\$66
54"	30"	22	\$1045	* TM2	+\$38	* CEK2	SFS2	+\$66
54"	36"	26	\$1060	* TM2	+\$38	* CEK2	SFS2	+\$66
60"	24"	20	\$580	* TM3	+\$57	* CEK3	SFS3	+\$99
60"	30"	24	\$1055	* TM3	+\$57	* CEK3	SFS3	+\$99
60"	36"	28	\$1070	* TM3	+\$57	* CEK3	SFS3	+\$99
66"	24"	21	\$585	* TM3	+\$57	* CEK3	SFS3	+\$99
66"	30"	25	\$1065	* TM3	+\$57	* CEK3	SFS3	+\$99
66"	36"	30	\$1080	* TM3	+\$57	* CEK3	SFS3	+\$99
72"	24"	22	\$595	* TM3	+\$57	* CEK3	SFS3	+\$99
72"	30"	27	\$1070	* TM3	+\$57	* CEK3	SFS3	+\$99
72"	36"	32	\$1090	* TM3	+\$57	* CEK3	SFS3	+\$99
90"	24"	28	\$615	* TM4	+\$76	* CEK4	SFS4	+\$132
90"	30"	34	\$1100	* TM4	+\$76	* CEK4	SFS4	+\$132
90"	36"	39	\$1120	* TM4	+\$76	* CEK4	SFS4	+\$132

* Clamps available in Silver (S) or Black (B)

NOTE:

All pricing in USD

Quantity of mounting clamps noted as last number in SKU



FRAMELESS SNEEZE GUARD

Style - Frosted Acrylic
(FRO)

MOUNTING OPTIONS

FADSG-FRO

* Clamps available in Silver (S) or Black (B)

Width	Height	Weight (lbs)	Base Price	Top Mount	Price	Edge Clamp Knob	Free Standing	Price
23"	24"	10	\$210	* TM2	+\$38	* CEK2	SFS2	+\$66
23"	30"	12	\$250	* TM2	+\$38	* CEK2	SFS2	+\$66
23"	36"	14	\$290	* TM2	+\$38	* CEK2	SFS2	+\$66
30"	24"	12	\$265	* TM2	+\$38	* CEK2	SFS2	+\$66
30"	30"	14	\$345	* TM2	+\$38	* CEK2	SFS2	+\$66
30"	36"	16	\$435	* TM2	+\$38	* CEK2	SFS2	+\$66
36"	24"	13	\$295	* TM2	+\$38	* CEK2	SFS2	+\$66
36"	30"	16	\$350	* TM2	+\$38	* CEK2	SFS2	+\$66
36"	36"	18	\$445	* TM2	+\$38	* CEK2	SFS2	+\$66
42"	24"	14	\$385	* TM2	+\$38	* CEK2	SFS2	+\$66
42"	30"	17	\$445	* TM2	+\$38	* CEK2	SFS2	+\$66
42"	36"	20	\$525	* TM2	+\$38	* CEK2	SFS2	+\$66
47"	24"	16	\$390	* TM2	+\$38	* CEK2	SFS2	+\$66
47"	30"	19	\$455	* TM2	+\$38	* CEK2	SFS2	+\$66
47"	36"	22	\$635	* TM2	+\$38	* CEK2	SFS2	+\$66
54"	24"	18	\$400	* TM2	+\$38	* CEK2	SFS2	+\$66
54"	30"	22	\$630	* TM2	+\$38	* CEK2	SFS2	+\$66
54"	36"	26	\$645	* TM2	+\$38	* CEK2	SFS2	+\$66
60"	24"	20	\$525	* TM3	+\$57	* CEK3	SFS3	+\$99
60"	30"	24	\$640	* TM3	+\$57	* CEK3	SFS3	+\$99
60"	36"	28	\$820	* TM3	+\$57	* CEK3	SFS3	+\$99
66"	24"	21	\$530	* TM3	+\$57	* CEK3	SFS3	+\$99
66"	30"	25	\$645	* TM3	+\$57	* CEK3	SFS3	+\$99
66"	36"	30	\$830	* TM3	+\$57	* CEK3	SFS3	+\$99
72"	24"	22	\$540	* TM3	+\$57	* CEK3	SFS3	+\$99
72"	30"	27	\$655	* TM3	+\$57	* CEK3	SFS3	+\$99
72"	36"	32	\$840	* TM3	+\$57	* CEK3	SFS3	+\$99
90"	24"	28	\$830	* TM4	+\$76	* CEK4	SFS4	+\$132
90"	30"	34	\$1185	* TM4	+\$76	* CEK4	SFS4	+\$132
90"	36"	39	\$1205	* TM4	+\$76	* CEK4	SFS4	+\$132

NOTE:

All pricing in USD

Quantity of mounting clamps noted as last number in SKU



Top Mount (TM)

- Use for permanent mounting
- Install anywhere on the desk
- Work on all thickness tops
- Clamp position on panel is adjustable
- Kits include 2 or 3 Top Mounts depending on the width of the desk divider



Top Mount (STM)



Top Mount (BTM)



Edge Clamp - Knob (CEK)

- Fast & easy installation and relocation
- Mount along the edge of work surface
- Clamp fits 3/4" to 2" thick tops
- No screwing or drilling into work surface required
- Clamp position on panel is adjustable
- Kits include 2 or 3 Clamps depending on the width of the desk divider



Edge Clamp - Knob (SCEK)



Edge Clamp - Knob (BCEK)



Free Standing Foot (FS)

- Fast & easy installation and relocation
- Stands freely on top of work surface
- Clamp position on panel is adjustable
- No screwing or drilling into work surface required
- A center Pad will be included on units 54" and wider



Free Standing (SFS)

SNEEZE GUARD LAYOUT FOR PANEL WIDTHS OF 23"-54"

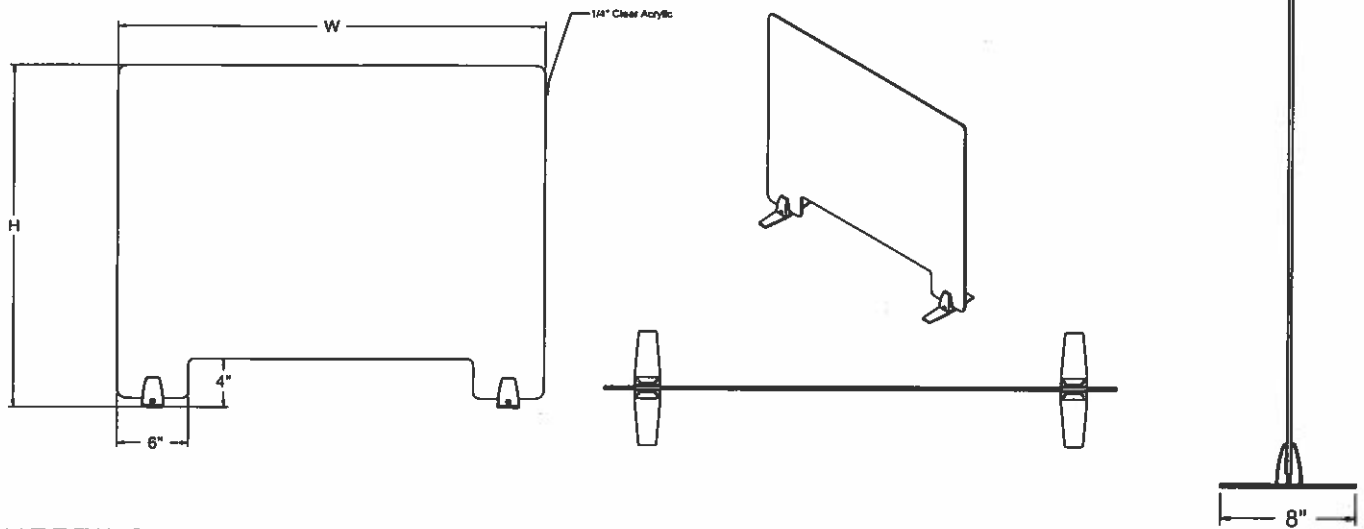

SNEEZE GUARD LAYOUT FOR PANEL WIDTHS OF 60"-72"

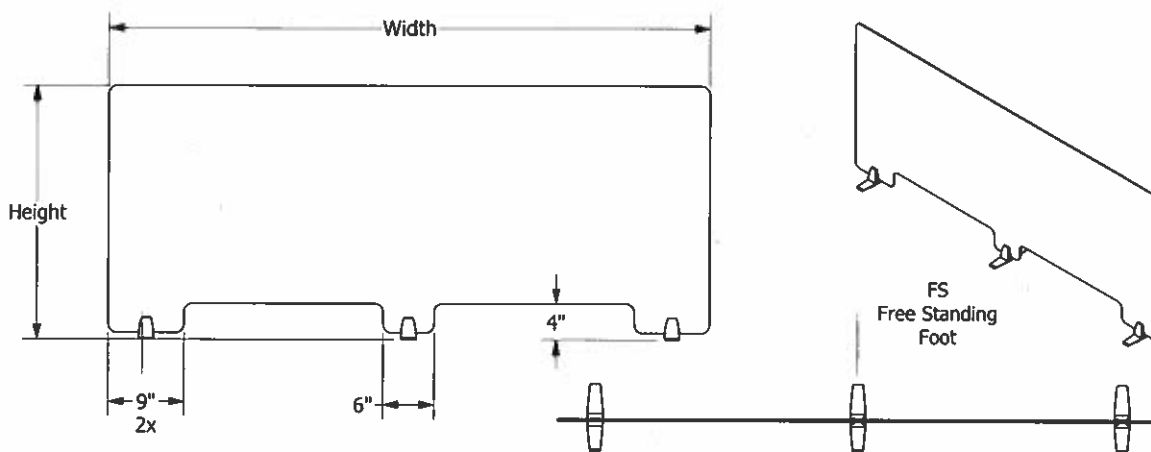

SNEEZE GUARD LAYOUT FOR PANEL WIDTH OF 90"

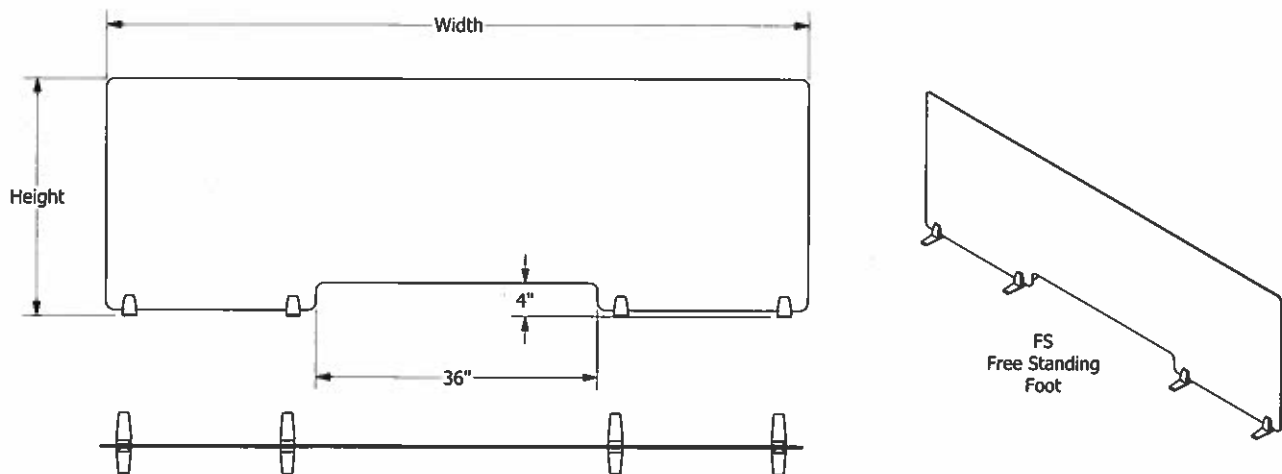

FRAMED SNEEZE GUARD

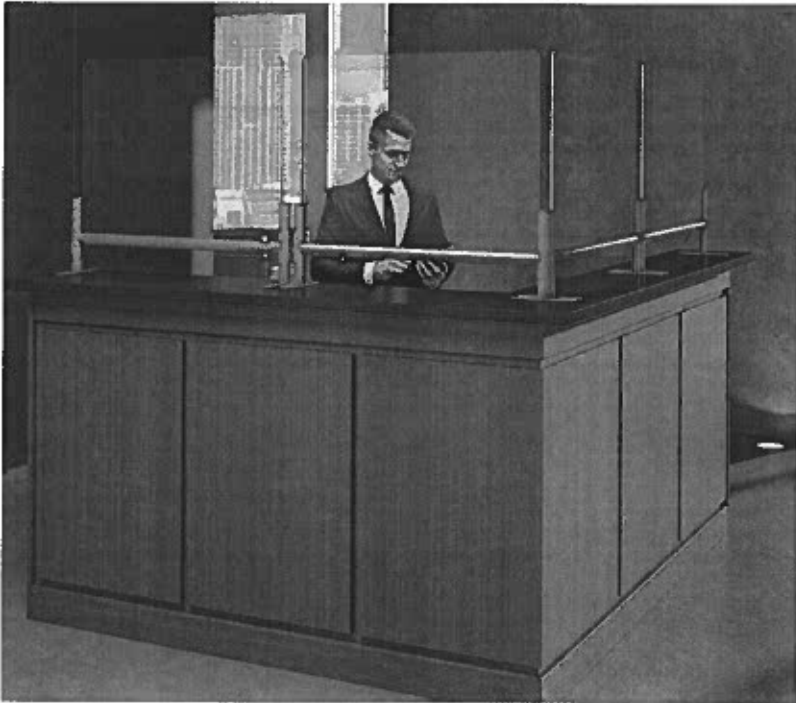

Protective Barrier Shields

Protect employees and customers with our high quality, professionally designed acrylic Sneeze Guard panels. Our see-through clear or frosted protective barriers are framed along the bottom edge and sit 4 inches off the surface for safe document and currency exchange. Framed Sneeze Guards are available in a variety of widths and heights to shield your entire worksurface.

Sneeze Guards can be mounted with free standing feet for a movable solution or be permanently fixed to your countertop or worksurface. Easy to disinfect and clean, AOI Sneeze Guards are an effective solution to keep your work environment safe and virus-free.

- Panels are available in clear and frosted acrylic
- Panels are available in several widths and heights for maximum coverage
- Light weight silver aluminum frame holds acrylic
- Panel length includes panel and frame
- Sneeze Guards sit 4" off the worksurface
- All acrylic edges are sanded for a smooth finish
- 1/4" thick Acrylic is easy to disinfect and clean
- Removable and permanent mounting options available
- Made in the USA
- Customization available – special materials, sizes, shapes and mounting

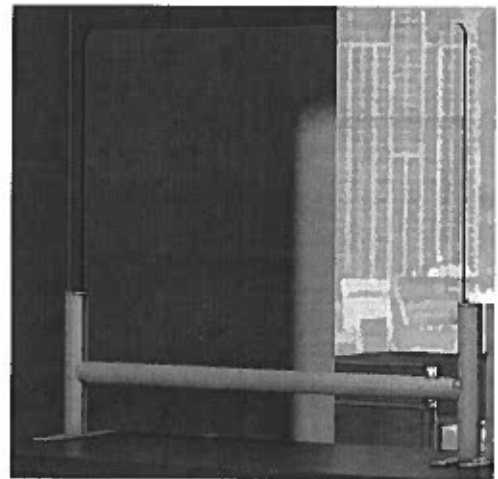

How to build your SKU:

Step 1: Model: **TTSG** — Step 2: Style: **CLR** — Step 3: Choose your Width: **30** — Choose your Height: **24** — Step 4: Choose your Frame Color: **AA** — Step 5: Choose your Mounting Option: **FS**

FRAMED SNEEZE GUARD

Model	Style	Width	Height	Frame	Mounting
TTSG Framed Sneeze Guard	CLR Clear Acrylic	24"	24"	AA Satin Aluminum	B Bolt Through
	FRO Frosted Acrylic	30"	28"	20 Pewter	SCEK Edge Clamp - Knob
		36"	36"		SFS Free Standing Foot
		42"			T Top Plate
		48"			
		60"			



FRAMED SNEEZE GUARD

Style - Clear Acrylic
(CLR)

MOUNTING OPTIONS

			TTSG-CLR	MOUNTING OPTIONS					
Width	Height	Weight (lbs)	Base Price	Bolt Through	Price	Edge Clamp Knob	Free Standing	Top Plate	Price
24"	24"	7	\$265	B2	+\$0	SCEK2	SFS2	T2	+\$40
24"	28"	8	\$290	B2	+\$0	SCEK2	SFS2	T2	+\$40
24"	36"	9	\$335	B2	+\$0	SCEK2	SFS2	T2	+\$40
30"	24"	8	\$300	B2	+\$0	SCEK2	SFS2	T2	+\$40
30"	28"	9	\$340	B2	+\$0	SCEK2	SFS2	T2	+\$40
30"	36"	11	\$480	B2	+\$0	SCEK2	SFS2	T2	+\$40
36"	24"	9	\$375	B2	+\$0	SCEK2	SFS2	T2	+\$40
36"	28"	10	\$380	B2	+\$0	SCEK2	SFS2	T2	+\$40
36"	36"	13	\$500	B2	+\$0	SCEK2	SFS2	T2	+\$40
42"	24"	10	\$390	B2	+\$0	SCEK2	SFS2	T2	+\$40
42"	28"	12	\$435	B2	+\$0	SCEK2	SFS2	T2	+\$40
42"	36"	15	\$520	B2	+\$0	SCEK2	SFS2	T2	+\$40
48"	24"	12	\$405	B2	+\$0	SCEK2	SFS2	T2	+\$40
48"	28"	14	\$455	B2	+\$0	SCEK2	SFS2	T2	+\$40
48"	36"	17	\$540	B2	+\$0	SCEK2	SFS2	T2	+\$40
54"	24"	13	\$655	B2	+\$0	SCEK2	SFS2	T2	+\$40
54"	28"	15	\$665	B2	+\$0	SCEK2	SFS2	T2	+\$40
54"	36"	19	\$1080	B2	+\$0	SCEK2	SFS2	T2	+\$40
60"	24"	14	\$670	B2	+\$0	SCEK2	SFS2	T2	+\$40
60"	28"	17	\$685	B2	+\$0	SCEK2	SFS2	T2	+\$40
60"	36"	21	\$1095	B2	+\$0	SCEK2	SFS2	T2	+\$40

FRAMED SNEEZE GUARD

Style - Frosted Acrylic
(FRO)

MOUNTING OPTIONS

			TTSG-FRO	MOUNTING OPTIONS					
Width	Height	Weight (lbs)	Base Price	Bolt Through	Price	Edge Clamp Knob	Free Standing	Top Plate	Price
24"	24"	7	\$265	B2	+\$0	SCEK2	SFS2	T2	+\$40
24"	28"	8	\$290	B2	+\$0	SCEK2	SFS2	T2	+\$40
24"	36"	9	\$335	B2	+\$0	SCEK2	SFS2	T2	+\$40
30"	24"	8	\$300	B2	+\$0	SCEK2	SFS2	T2	+\$40
30"	28"	9	\$340	B2	+\$0	SCEK2	SFS2	T2	+\$40
30"	36"	11	\$480	B2	+\$0	SCEK2	SFS2	T2	+\$40
36"	24"	9	\$375	B2	+\$0	SCEK2	SFS2	T2	+\$40
36"	28"	10	\$380	B2	+\$0	SCEK2	SFS2	T2	+\$40
36"	36"	13	\$500	B2	+\$0	SCEK2	SFS2	T2	+\$40
42"	24"	10	\$390	B2	+\$0	SCEK2	SFS2	T2	+\$40
42"	28"	12	\$435	B2	+\$0	SCEK2	SFS2	T2	+\$40
42"	36"	15	\$520	B2	+\$0	SCEK2	SFS2	T2	+\$40
48"	24"	12	\$405	B2	+\$0	SCEK2	SFS2	T2	+\$40
48"	28"	14	\$455	B2	+\$0	SCEK2	SFS2	T2	+\$40
48"	36"	17	\$540	B2	+\$0	SCEK2	SFS2	T2	+\$40
54"	24"	13	\$455	B2	+\$0	SCEK2	SFS2	T2	+\$40
54"	28"	15	\$490	B2	+\$0	SCEK2	SFS2	T2	+\$40
54"	36"	19	\$665	B2	+\$0	SCEK2	SFS2	T2	+\$40
60"	24"	14	\$475	B2	+\$0	SCEK2	SFS2	T2	+\$40
60"	28"	17	\$510	B2	+\$0	SCEK2	SFS2	T2	+\$40
60"	36"	21	\$685	B2	+\$0	SCEK2	SFS2	T2	+\$40

NOTE: All pricing in USD

Quantity of mounting clamps noted as last number in SKU

FRAME COLOR



Satin Aluminum
AA



Pewter
20

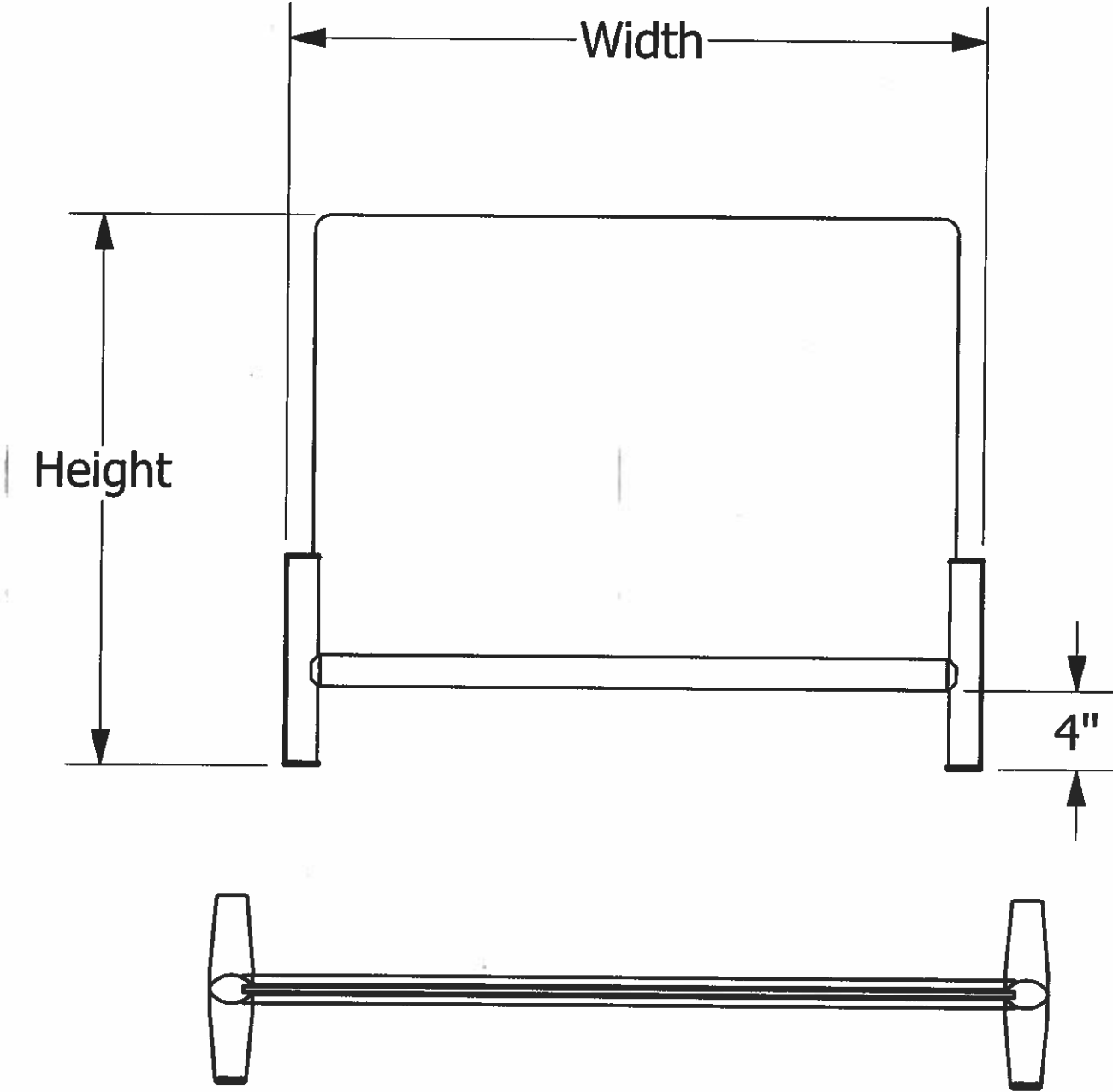

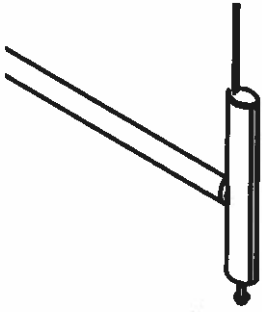

Bolt Through (B)

- Permanent mounting (Requires drilling in worksurface)
- Works on all thickness tops

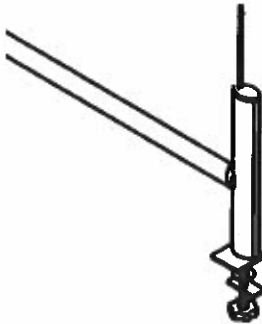

Edge Clamp - Knob (CEK)

- Fast & easy installation and relocation
- Mount along the edge of work surface
- Clamp fits 3/4" to 2" thick tops
- No screwing or drilling into work surface required

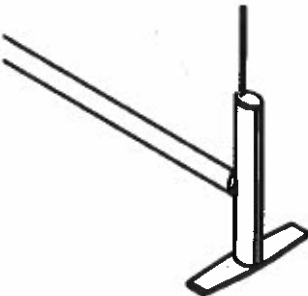

Free Standing Foot (FS)

- Fast & easy installation and relocation
- Stands freely on top of work surface



Top Plate (T)

- Use for permanent mounting
- Works on all thickness tops
- Top Plate rotates for single or double sided attachment
- Top Plate positions are adjustable



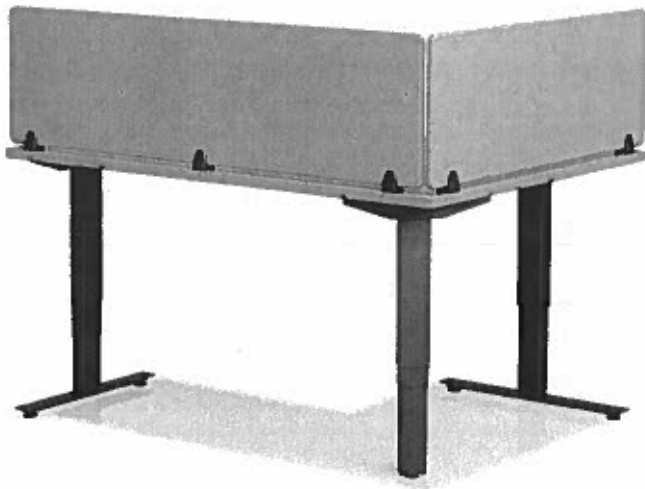

ABOVE THE DESK DIVIDERS

Desk dividers are the perfect solution for both visual and sound privacy. Available in a wide range of styles, colors, materials and acoustic properties, our panels are designed to merge with any work surface. With a simple installation process and a variety of permanent and removeable mounting options, you can turn existing desks and tables into personalized workstations that help maintain productivity and tune out distractions.

- Desk dividers available in several materials and colors including Clear and Frosted Acrylic, Fabric, TruBrite™ Whiteboard and EchoScape™
- Tackable fabric panels are finished with 3 different trim options: Fabric Fold, Edge Band and Metal Trim
- EchoScape™ 3/4" (18mm), our 0.9 NRC rated acoustic solution, effectively controls noise disruptions by absorbing sound
- Permanent and removeable mounting options available
- Made in the USA
- Customization available – special materials, sizes, shapes and mounting options



FROSTED ACRYLIC
(Style FRO)
CLEAR ACRYLIC
(Style CLR)



TRUBRITE™ WHITEBOARD
(Style WB)

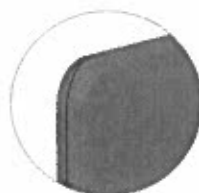

FABRIC FOLD
(Style FF)

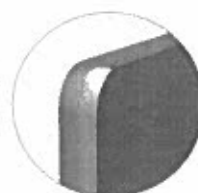

EDGE BAND
(Style EB2)



METAL TRIM
(Style MT2)



ECHOSCAPE™
(Style PE18 and IPE18)

How to build your SKU:

Step 1: Choose your Model: **FAD** — Step 2: Choose your Style: **PE18** — Step 3: Choose your Width: **23** — Step 3: Choose your Height: **12** — Step 4: Choose your Material Color: **P101** — Step 5: Choose Your Edge Band Color (EB Style only): **BK** — Step 6: Banner Cutout Design (optional) (PE18 and IPE18 Styles only): **D004** — Step 7: Choose your Mounting Option: **BCEK**

DESK DIVIDER PANELS

Model	Style	Width	Height	Material Color	Edge Band (EB Style only)	Banner Cutout Designs (optional) (PE18 and IPE18 Styles only)	Mounting	
FAD DDD Panel	FRO	Frosted Acrylic	17"	12"	F1_ Fabric Series 100	SV Silver	D002 Fuzzy	*TM Top Mount (silver or black)
	CLR	Clear Acrylic	23"	16"	F2_ Fabric Series 200	BK Black	D004 Metro	*CEK Edge Clamp - Knob (silver or black)
	WB	TruBrite™ Whiteboard	29"	18"	P1_ EchoScape™ 3/4 (18mm)	WT White	D005 Dash	*CEL Edge Clamp - Lever (silver or black)
	FF	Fabric Fold	36"	24"			D008 Tribal	SCEH Edge Clamp - Hex (silver)
	EB2	Edge Band	42"	30"			D016 Retro	SCMS Middle Clamp (silver)
	MT2	Metal Trim	48"				D017 Strata	SCMD Middle Clamp - Double (silver)
	PE18	EchoScape™	54"				D021 Maze	SCMKS Middle Clamp - Knob (silver)
	IPE18	EchoScape™ Invisible Mount	60"				D022 Aztec	SFS Free Standing (silver)
			66"				D023 Pinwheel	SBM Bench Mount (silver)
			72"					IM Invisible Mount

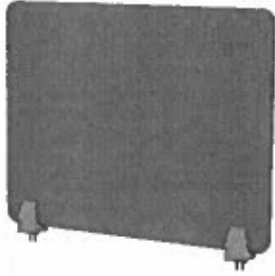

Top Mount (TM)

- Use for permanent mounting
- Install anywhere on the desk
- Work on all thickness tops
- Clamp position on panel is adjustable
- Kits include 2 or 3 Top Mounts depending on the width of the desk divider



Top Mount (STM)



Top Mount (BTM)

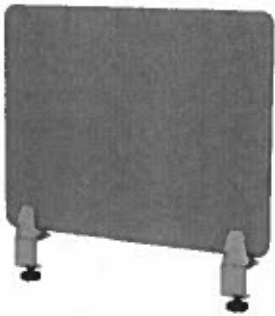

Edge Clamp - Knob (CEK)

- Fast & easy installation and relocation
- Mount along the edge of work surface
- Clamp fits 3/4" to 2" thick tops
- No screwing or drilling into work surface required
- Clamp position on panel is adjustable
- Kits include 2 or 3 Clamps depending on the width of the desk divider



Edge Clamp - Knob (SCEK)



Edge Clamp - Knob (BCEK)

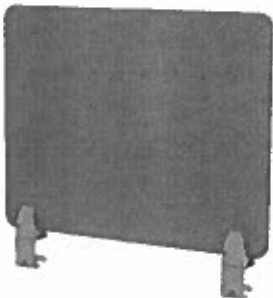

Edge Clamp - Lever (CEL)

- Patented Lever allows for easy installation with no hanging knob
 - Fast & easy installation and relocation
 - Mount along the edge of work surface
 - Clamp fits 5/8" to 2" thick tops
 - No screwing or drilling into work surface required
 - Clamp position on panel is adjustable
 - Kits include 2 or 3 Clamps depending on the width of the desk divider
- *Patented*



Edge Clamp - Lever (SCEL)



Edge Clamp - Lever (BCEL)



Edge Clamp - Hex (CEH) (Low Profile)

- Fast & easy installation and relocation
- Mount along the edge of work surface
- Clamp fits 1.1" to 1.22" thick tops
- No screwing or drilling into work surface required
- Clamp position on panel is adjustable
- Kits include 2 or 3 Clamps depending on the width of the desk divider
- Use when minimum free space is available on underside of work surface



Edge Clamp - Hex (SCEH)



Middle Clamp - Single (CMS)

- Patented Lever allows for easy installation with no low hanging knob
 - Fast & easy installation and relocation
 - Mount perpendicular to edge of work surface
 - Clamp fits 5/8" to 2" thick tops
 - No screwing or drilling into work surface required
 - Only one clamp required to secure a desk divider
- *Patented



Middle Clamp - Single (SCMS)

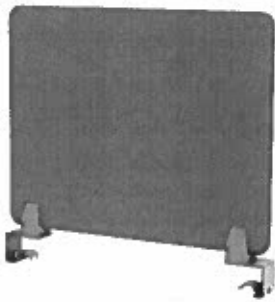

Middle Clamp - Double (CMD)

- Patented Lever allows for easy installation with no low hanging knob
 - Fast & easy installation and relocation
 - Mount perpendicular to edge of work surface
 - Clamp fits 5/8" to 2" thick tops
 - No screwing or drilling into work surface required
 - Two clamps for use with larger dividers
 - A center Pad will be included on units 54" and wider
- *Patented



Middle Clamp - Double (SCMD)



Center Pad (54" and wider)

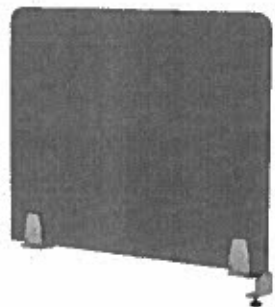

Middle Clamp - Knob (CMKS)

- Fast & easy installation and relocation
- Mount perpendicular to edge of work surface
- Clamp fits 1.1" to 1.22" thick tops
- No screwing or drilling into work surface
- Only one clamp required to secure panel to work surface
- Kit includes 1 middle clamp with knob and one or two metal resting plates depending on width of panel



Middle Clamp - Knob (SCMKS)



Free Standing Foot (FS)

- Fast & easy installation and relocation
- Stands freely on top of work surface
- Clamp position on panel is adjustable
- No screwing or drilling into work surface required
- A center Pad will be included on units 54" and wider



Free Standing (SFS)



Center Pad (54" and wider)



Bench Mount (BM)

- Use for permanent mounting
- Fits between back to back workstations with a minimum gap of 2.25"
- Clamp position on panel is adjustable
- Can be used on all thickness tops
- Kit includes 2 to 3 Bench Mounts depending on width of the panel



Bench Mount (SBM)

FROSTED ACRYLIC



ALLSTATE
OFFICE INTERIORS

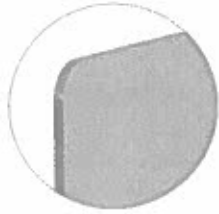

DESK DIVIDER
Style - Frosted Acrylic
(FRO)

Shown with Edge
Clamp - Hex (SCEH)

* Clamps available in
Silver (S) or Black (B)

MOUNTING OPTIONS

FAD-FRO				Top Mount	Price	Edge Clamp Knob	Edge Clamp Lever	Edge Clamp Hex	Middle Clamp	Middle Clamp Double	Middle Clamp Knob	Free Standing	Bench Mount	Price
Width	Height	Weight (lbs)	Base Price											
17"	12"	5	\$90	* TM2	+\$38	* CEK2	* CEL2	SCEH2	SCMS	SCMD	SCMKS	SFS2	SBM2	+\$66
17"	16"	5	\$110	* TM2	+\$38	* CEK2	* CEL2	SCEH2	SCMS	SCMD	SCMKS	SFS2	SBM2	+\$66
17"	18"	6	\$120	* TM2	+\$38	* CEK2	* CEL2	SCEH2	SCMS	SCMD	SCMKS	SFS2	SBM2	+\$66
17"	24"	7	\$140	* TM2	+\$38	* CEK2	* CEL2	SCEH2	SCMS	SCMD	SCMKS	SFS2	SBM2	+\$66
17"	30"	8	\$165	* TM2	+\$38	* CEK2	* CEL2	SCEH2	SCMS	SCMD	SCMKS	SFS2	SBM2	+\$66
23"	12"	5	\$110	* TM2	+\$38	* CEK2	* CEL2	SCEH2	SCMS	SCMD	SCMKS	SFS2	SBM2	+\$66
23"	16"	6	\$125	* TM2	+\$38	* CEK2	* CEL2	SCEH2	SCMS	SCMD	SCMKS	SFS2	SBM2	+\$66
23"	18"	7	\$140	* TM2	+\$38	* CEK2	* CEL2	SCEH2	SCMS	SCMD	SCMKS	SFS2	SBM2	+\$66
23"	24"	8	\$175	* TM2	+\$38	* CEK2	* CEL2	SCEH2	SCMS	SCMD	SCMKS	SFS2	SBM2	+\$66
23"	30"	9	\$210	* TM2	+\$38	* CEK2	* CEL2	SCEH2	SCMS	SCMD	SCMKS	SFS2	SBM2	+\$66
29"	12"	6	\$125	* TM2	+\$38	* CEK2	* CEL2	SCEH2	SCMS	SCMD	SCMKS	SFS2	SBM2	+\$66
29"	16"	7	\$145	* TM2	+\$38	* CEK2	* CEL2	SCEH2	SCMS	SCMD	SCMKS	SFS2	SBM2	+\$66
29"	18"	8	\$170	* TM2	+\$38	* CEK2	* CEL2	SCEH2	SCMS	SCMD	SCMKS	SFS2	SBM2	+\$66
29"	24"	9	\$210	* TM2	+\$38	* CEK2	* CEL2	SCEH2	SCMS	SCMD	SCMKS	SFS2	SBM2	+\$66
29"	30"	11	\$285	* TM2	+\$38	* CEK2	* CEL2	SCEH2	SCMS	SCMD	SCMKS	SFS2	SBM2	+\$66
36"	12"	7	\$145	* TM2	+\$38	* CEK2	* CEL2	SCEH2	N/A	SCMD	N/A	SFS2	SBM2	+\$66
36"	16"	8	\$180	* TM2	+\$38	* CEK2	* CEL2	SCEH2	N/A	SCMD	N/A	SFS2	SBM2	+\$66
36"	18"	9	\$205	* TM2	+\$38	* CEK2	* CEL2	SCEH2	N/A	SCMD	N/A	SFS2	SBM2	+\$66
36"	24"	11	\$245	* TM2	+\$38	* CEK2	* CEL2	SCEH2	N/A	SCMD	N/A	SFS2	SBM2	+\$66
36"	30"	13	\$295	* TM2	+\$38	* CEK2	* CEL2	SCEH2	N/A	SCMD	N/A	SFS2	SBM2	+\$66
42"	12"	7	\$170	* TM2	+\$38	* CEK2	* CEL2	SCEH2	N/A	SCMD	N/A	SFS2	SBM2	+\$66
42"	16"	9	\$210	* TM2	+\$38	* CEK2	* CEL2	SCEH2	N/A	SCMD	N/A	SFS2	SBM2	+\$66
42"	18"	10	\$240	* TM2	+\$38	* CEK2	* CEL2	SCEH2	N/A	SCMD	N/A	SFS2	SBM2	+\$66
42"	24"	12	\$320	* TM2	+\$38	* CEK2	* CEL2	SCEH2	N/A	SCMD	N/A	SFS2	SBM2	+\$66
42"	30"	15	\$370	* TM2	+\$38	* CEK2	* CEL2	SCEH2	N/A	SCMD	N/A	SFS2	SBM2	+\$66
48"	12"	8	\$190	* TM2	+\$38	* CEK2	* CEL2	SCEH2	N/A	SCMD	N/A	SFS2	SBM2	+\$66
48"	16"	10	\$225	* TM2	+\$38	* CEK2	* CEL2	SCEH2	N/A	SCMD	N/A	SFS2	SBM2	+\$66
48"	18"	11	\$265	* TM2	+\$38	* CEK2	* CEL2	SCEH2	N/A	SCMD	N/A	SFS2	SBM2	+\$66
48"	24"	14	\$325	* TM2	+\$38	* CEK2	* CEL2	SCEH2	N/A	SCMD	N/A	SFS2	SBM2	+\$66
48"	30"	17	\$380	* TM2	+\$38	* CEK2	* CEL2	SCEH2	N/A	SCMD	N/A	SFS2	SBM2	+\$66
54"	12"	9	\$195	* TM2	+\$38	* CEK2	* CEL2	SCEH2	N/A	SCMD	N/A	SFS2	SBM2	+\$66
54"	16"	11	\$250	* TM2	+\$38	* CEK2	* CEL2	SCEH2	N/A	SCMD	N/A	SFS2	SBM2	+\$66
54"	18"	12	\$290	* TM2	+\$38	* CEK2	* CEL2	SCEH2	N/A	SCMD	N/A	SFS2	SBM2	+\$66
54"	24"	15	\$335	* TM2	+\$38	* CEK2	* CEL2	SCEH2	N/A	SCMD	N/A	SFS2	SBM2	+\$66
54"	30"	19	\$525	* TM2	+\$38	* CEK2	* CEL2	SCEH2	N/A	SCMD	N/A	SFS2	SBM2	+\$66
60"	12"	10	\$230	* TM3	+\$57	* CEK3	* CEL3	SCEH3	N/A	SCMDP	N/A	SFS2P	SBM3	+\$99
60"	16"	13	\$295	* TM3	+\$57	* CEK3	* CEL3	SCEH3	N/A	SCMDP	N/A	SFS2P	SBM3	+\$99
60"	18"	14	\$325	* TM3	+\$57	* CEK3	* CEL3	SCEH3	N/A	SCMDP	N/A	SFS2P	SBM3	+\$99
60"	24"	18	\$430	* TM3	+\$57	* CEK3	* CEL3	SCEH3	N/A	SCMDP	N/A	SFS2P	SBM3	+\$99
60"	30"	21	\$530	* TM3	+\$57	* CEK3	* CEL3	SCEH3	N/A	SCMDP	N/A	SFS2P	SBM3	+\$99
66"	12"	11	\$235	* TM3	+\$57	* CEK3	* CEL3	SCEH3	N/A	SCMDP	N/A	SFS2P	SBM3	+\$99
66"	16"	14	\$300	* TM3	+\$57	* CEK3	* CEL3	SCEH3	N/A	SCMDP	N/A	SFS2P	SBM3	+\$99
66"	18"	15	\$330	* TM3	+\$57	* CEK3	* CEL3	SCEH3	N/A	SCMDP	N/A	SFS2P	SBM3	+\$99
66"	24"	19	\$435	* TM3	+\$57	* CEK3	* CEL3	SCEH3	N/A	SCMDP	N/A	SFS2P	SBM3	+\$99
66"	30"	23	\$540	* TM3	+\$57	* CEK3	* CEL3	SCEH3	N/A	SCMDP	N/A	SFS2P	SBM3	+\$99
72"	12"	12	\$255	* TM3	+\$57	* CEK3	* CEL3	SCEH3	N/A	SCMDP	N/A	SFS2P	SBM3	+\$99
72"	16"	15	\$305	* TM3	+\$57	* CEK3	* CEL3	SCEH3	N/A	SCMDP	N/A	SFS2P	SBM3	+\$99
72"	18"	16	\$375	* TM3	+\$57	* CEK3	* CEL3	SCEH3	N/A	SCMDP	N/A	SFS2P	SBM3	+\$99
72"	24"	21	\$445	* TM3	+\$57	* CEK3	* CEL3	SCEH3	N/A	SCMDP	N/A	SFS2P	SBM3	+\$99
72"	30"	25	\$545	* TM3	+\$57	* CEK3	* CEL3	SCEH3	N/A	SCMDP	N/A	SFS2P	SBM3	+\$99

NOTE:

All pricing in USD

* Dimension is 1" less than width of desk to allow for rear panel

Quantity of mounting clamps noted as last number in SKU

Middle Clamp Double (SCMD) includes 2 clamps

Middle Clamp (SCMS) and Middle Clamp Knob (SCMKS) kits include 1 clamp and 1 metal stability plate

Middle Clamp Double with Pad (SCMDP) for panel widths 54" and larger, includes 2 clamps and 1 stability plate



DESK DIVIDER

Style - Clear Acrylic (CLR)

* Clamps available in Silver (S) or Black (B)

MOUNTING OPTIONS

			FAD-CLR											
Width	Height	Weight (lbs)	Base Price	Top Mount	Price	Edge Clamp Knob	Edge Clamp Lever	Edge Clamp Hex	Middle Clamp	Middle Clamp Double	Middle Clamp Knob	Free Standing	Bench Mount	Price
17"	12"	5	\$90	* TM2	+\$38	* CEK2	* CEL2	SCEH2	SCMS	SCMD	SCMKS	SFS2	SBM2	+\$66
17"	16"	5	\$110	* TM2	+\$38	* CEK2	* CEL2	SCEH2	SCMS	SCMD	SCMKS	SFS2	SBM2	+\$66
17"	18"	6	\$130	* TM2	+\$38	* CEK2	* CEL2	SCEH2	SCMS	SCMD	SCMKS	SFS2	SBM2	+\$66
17"	24"	7	\$140	* TM2	+\$38	* CEK2	* CEL2	SCEH2	SCMS	SCMD	SCMKS	SFS2	SBM2	+\$66
17"	30"	8	\$190	* TM2	+\$38	* CEK2	* CEL2	SCEH2	SCMS	SCMD	SCMKS	SFS2	SBM2	+\$66
23"	12"	5	\$110	* TM2	+\$38	* CEK2	* CEL2	SCEH2	SCMS	SCMD	SCMKS	SFS2	SBM2	+\$66
23"	16"	6	\$125	* TM2	+\$38	* CEK2	* CEL2	SCEH2	SCMS	SCMD	SCMKS	SFS2	SBM2	+\$66
23"	18"	7	\$140	* TM2	+\$38	* CEK2	* CEL2	SCEH2	SCMS	SCMD	SCMKS	SFS2	SBM2	+\$66
23"	24"	8	\$175	* TM2	+\$38	* CEK2	* CEL2	SCEH2	SCMS	SCMD	SCMKS	SFS2	SBM2	+\$66
23"	30"	9	\$210	* TM2	+\$38	* CEK2	* CEL2	SCEH2	SCMS	SCMD	SCMKS	SFS2	SBM2	+\$66
29"	12"	6	\$125	* TM2	+\$38	* CEK2	* CEL2	SCEH2	SCMS	SCMD	SCMKS	SFS2	SBM2	+\$66
29"	16"	7	\$145	* TM2	+\$38	* CEK2	* CEL2	SCEH2	SCMS	SCMD	SCMKS	SFS2	SBM2	+\$66
29"	18"	8	\$170	* TM2	+\$38	* CEK2	* CEL2	SCEH2	SCMS	SCMD	SCMKS	SFS2	SBM2	+\$66
29"	24"	9	\$210	* TM2	+\$38	* CEK2	* CEL2	SCEH2	SCMS	SCMD	SCMKS	SFS2	SBM2	+\$66
29"	30"	11	\$335	* TM2	+\$38	* CEK2	* CEL2	SCEH2	SCMS	SCMD	SCMKS	SFS2	SBM2	+\$66
36"	12"	7	\$145	* TM2	+\$38	* CEK2	* CEL2	SCEH2	N/A	SCMD	N/A	SFS2	SBM2	+\$66
36"	16"	8	\$180	* TM2	+\$38	* CEK2	* CEL2	SCEH2	N/A	SCMD	N/A	SFS2	SBM2	+\$66
36"	18"	9	\$225	* TM2	+\$38	* CEK2	* CEL2	SCEH2	N/A	SCMD	N/A	SFS2	SBM2	+\$66
36"	24"	11	\$320	* TM2	+\$38	* CEK2	* CEL2	SCEH2	N/A	SCMD	N/A	SFS2	SBM2	+\$66
36"	30"	13	\$405	* TM2	+\$38	* CEK2	* CEL2	SCEH2	N/A	SCMD	N/A	SFS2	SBM2	+\$66
42"	12"	7	\$170	* TM2	+\$38	* CEK2	* CEL2	SCEH2	N/A	SCMD	N/A	SFS2	SBM2	+\$66
42"	16"	9	\$210	* TM2	+\$38	* CEK2	* CEL2	SCEH2	N/A	SCMD	N/A	SFS2	SBM2	+\$66
42"	18"	10	\$240	* TM2	+\$38	* CEK2	* CEL2	SCEH2	N/A	SCMD	N/A	SFS2	SBM2	+\$66
42"	24"	12	\$325	* TM2	+\$38	* CEK2	* CEL2	SCEH2	N/A	SCMD	N/A	SFS2	SBM2	+\$66
42"	30"	15	\$415	* TM2	+\$38	* CEK2	* CEL2	SCEH2	N/A	SCMD	N/A	SFS2	SBM2	+\$66
48"	12"	8	\$260	* TM2	+\$38	* CEK2	* CEL2	SCEH2	N/A	SCMD	N/A	SFS2	SBM2	+\$66
48"	16"	10	\$335	* TM2	+\$38	* CEK2	* CEL2	SCEH2	N/A	SCMD	N/A	SFS2	SBM2	+\$66
48"	18"	11	\$465	* TM2	+\$38	* CEK2	* CEL2	SCEH2	N/A	SCMD	N/A	SFS2	SBM2	+\$66
48"	24"	14	\$475	* TM2	+\$38	* CEK2	* CEL2	SCEH2	N/A	SCMD	N/A	SFS2	SBM2	+\$66
48"	30"	17	\$875	* TM2	+\$38	* CEK2	* CEL2	SCEH2	N/A	SCMD	N/A	SFS2	SBM2	+\$66
54"	12"	9	\$265	* TM2	+\$38	* CEK2	* CEL2	SCEH2	N/A	SCMD	N/A	SFS2	SBM2	+\$66
54"	16"	11	\$340	* TM2	+\$38	* CEK2	* CEL2	SCEH2	N/A	SCMD	N/A	SFS2	SBM2	+\$66
54"	18"	12	\$470	* TM2	+\$38	* CEK2	* CEL2	SCEH2	N/A	SCMD	N/A	SFS2	SBM2	+\$66
54"	24"	15	\$485	* TM2	+\$38	* CEK2	* CEL2	SCEH2	N/A	SCMD	N/A	SFS2	SBM2	+\$66
54"	30"	19	\$885	* TM2	+\$38	* CEK2	* CEL2	SCEH2	N/A	SCMD	N/A	SFS2	SBM2	+\$66
60"	12"	10	\$270	* TM3	+\$57	* CEK3	* CEL3	SCEH3	N/A	SCMDP	N/A	SFS2P	SBM3	+\$99
60"	16"	13	\$345	* TM3	+\$57	* CEK3	* CEL3	SCEH3	N/A	SCMDP	N/A	SFS2P	SBM3	+\$99
60"	18"	14	\$475	* TM3	+\$57	* CEK3	* CEL3	SCEH3	N/A	SCMDP	N/A	SFS2P	SBM3	+\$99
60"	24"	18	\$490	* TM3	+\$57	* CEK3	* CEL3	SCEH3	N/A	SCMDP	N/A	SFS2P	SBM3	+\$99
60"	30"	21	\$890	* TM3	+\$57	* CEK3	* CEL3	SCEH3	N/A	SCMDP	N/A	SFS2P	SBM3	+\$99
66"	12"	11	\$275	* TM3	+\$57	* CEK3	* CEL3	SCEH3	N/A	SCMDP	N/A	SFS2P	SBM3	+\$99
66"	16"	14	\$350	* TM3	+\$57	* CEK3	* CEL3	SCEH3	N/A	SCMDP	N/A	SFS2P	SBM3	+\$99
66"	18"	15	\$485	* TM3	+\$57	* CEK3	* CEL3	SCEH3	N/A	SCMDP	N/A	SFS2P	SBM3	+\$99
66"	24"	19	\$495	* TM3	+\$57	* CEK3	* CEL3	SCEH3	N/A	SCMDP	N/A	SFS2P	SBM3	+\$99
66"	30"	23	\$900	* TM3	+\$57	* CEK3	* CEL3	SCEH3	N/A	SCMDP	N/A	SFS2P	SBM3	+\$99
72"	12"	12	\$280	* TM3	+\$57	* CEK3	* CEL3	SCEH3	N/A	SCMDP	N/A	SFS2P	SBM3	+\$99
72"	16"	15	\$350	* TM3	+\$57	* CEK3	* CEL3	SCEH3	N/A	SCMDP	N/A	SFS2P	SBM3	+\$99
72"	18"	16	\$485	* TM3	+\$57	* CEK3	* CEL3	SCEH3	N/A	SCMDP	N/A	SFS2P	SBM3	+\$99
72"	24"	21	\$500	* TM3	+\$57	* CEK3	* CEL3	SCEH3	N/A	SCMDP	N/A	SFS2P	SBM3	+\$99
72"	30"	25	\$905	* TM3	+\$57	* CEK3	* CEL3	SCEH3	N/A	SCMDP	N/A	SFS2P	SBM3	+\$99

NOTE:

All pricing in USD

* Dimension is 1" less than width of desk to allow for rear panel

Quantity of mounting clamps noted as last number in SKU

Middle Clamp Double (SCMD) includes 2 clamps

Middle Clamp (SCMS) and Middle Clamp Knob (SCMKS) kits include 1 clamp and 1 metal stability plate

Middle Clamp Double with Pad (SCMDP) for panel widths 54" and larger, includes 2 clamps and 1 stability plate



DESK DIVIDER
Style - TruBrite™ Whiteboard
(WB)

Shown with Edge
Clamp - Knob (SCEK)

* Clamps available in
Silver (S) or Black (B)

MOUNTING OPTIONS

FAD-WB				Top Mount	Price	Edge Clamp Knob	Edge Clamp Lever	Edge Clamp Hex	Middle Clamp	Middle Clamp Double	Middle Clamp Knob	Free Standing	Bench Mount	Price
17"	12"	6	\$135	* TM2	+\$38	* CEK2	* CEL2	SCEH2	SCMS	SCMD	SCMKS	SFS2	SBM2	+\$66
17"	16"	7	\$155	* TM2	+\$38	* CEK2	* CEL2	SCEH2	SCMS	SCMD	SCMKS	SFS2	SBM2	+\$66
17"	18"	8	\$180	* TM2	+\$38	* CEK2	* CEL2	SCEH2	SCMS	SCMD	SCMKS	SFS2	SBM2	+\$66
17"	24"	9	\$195	* TM2	+\$38	* CEK2	* CEL2	SCEH2	SCMS	SCMD	SCMKS	SFS2	SBM2	+\$66
17"	30"	11	\$255	* TM2	+\$38	* CEK2	* CEL2	SCEH2	SCMS	SCMD	SCMKS	SFS2	SBM2	+\$66
23"	12"	7	\$155	* TM2	+\$38	* CEK2	* CEL2	SCEH2	SCMS	SCMD	SCMKS	SFS2	SBM2	+\$66
23"	16"	9	\$180	* TM2	+\$38	* CEK2	* CEL2	SCEH2	SCMS	SCMD	SCMKS	SFS2	SBM2	+\$66
23"	18"	9	\$195	* TM2	+\$38	* CEK2	* CEL2	SCEH2	SCMS	SCMD	SCMKS	SFS2	SBM2	+\$66
23"	24"	12	\$225	* TM2	+\$38	* CEK2	* CEL2	SCEH2	SCMS	SCMD	SCMKS	SFS2	SBM2	+\$66
23"	30"	14	\$270	* TM2	+\$38	* CEK2	* CEL2	SCEH2	SCMS	SCMD	SCMKS	SFS2	SBM2	+\$66
29"	12"	8	\$185	* TM2	+\$38	* CEK2	* CEL2	SCEH2	SCMS	SCMD	SCMKS	SFS2	SBM2	+\$66
29"	16"	10	\$210	* TM2	+\$38	* CEK2	* CEL2	SCEH2	SCMS	SCMD	SCMKS	SFS2	SBM2	+\$66
29"	18"	11	\$225	* TM2	+\$38	* CEK2	* CEL2	SCEH2	SCMS	SCMD	SCMKS	SFS2	SBM2	+\$66
29"	24"	14	\$270	* TM2	+\$38	* CEK2	* CEL2	SCEH2	SCMS	SCMD	SCMKS	SFS2	SBM2	+\$66
29"	30"	17	\$415	* TM2	+\$38	* CEK2	* CEL2	SCEH2	SCMS	SCMD	SCMKS	SFS2	SBM2	+\$66
36"	12"	10	\$210	* TM2	+\$38	* CEK2	* CEL2	SCEH2	N/A	SCMD	N/A	SFS2	SBM2	+\$66
36"	16"	12	\$250	* TM2	+\$38	* CEK2	* CEL2	SCEH2	N/A	SCMD	N/A	SFS2	SBM2	+\$66
36"	18"	13	\$290	* TM2	+\$38	* CEK2	* CEL2	SCEH2	N/A	SCMD	N/A	SFS2	SBM2	+\$66
36"	24"	17	\$310	* TM2	+\$38	* CEK2	* CEL2	SCEH2	N/A	SCMD	N/A	SFS2	SBM2	+\$66
36"	30"	20	\$430	* TM2	+\$38	* CEK2	* CEL2	SCEH2	N/A	SCMD	N/A	SFS2	SBM2	+\$66
42"	12"	11	\$230	* TM2	+\$38	* CEK2	* CEL2	SCEH2	N/A	SCMD	N/A	SFS2	SBM2	+\$66
42"	16"	14	\$275	* TM2	+\$38	* CEK2	* CEL2	SCEH2	N/A	SCMD	N/A	SFS2	SBM2	+\$66
42"	18"	15	\$305	* TM2	+\$38	* CEK2	* CEL2	SCEH2	N/A	SCMD	N/A	SFS2	SBM2	+\$66
42"	24"	19	\$355	* TM2	+\$38	* CEK2	* CEL2	SCEH2	N/A	SCMD	N/A	SFS2	SBM2	+\$66
42"	30"	23	\$445	* TM2	+\$38	* CEK2	* CEL2	SCEH2	N/A	SCMD	N/A	SFS2	SBM2	+\$66
48"	12"	12	\$255	* TM2	+\$38	* CEK2	* CEL2	SCEH2	N/A	SCMD	N/A	SFS2	SBM2	+\$66
48"	16"	15	\$290	* TM2	+\$38	* CEK2	* CEL2	SCEH2	N/A	SCMD	N/A	SFS2	SBM2	+\$66
48"	18"	17	\$320	* TM2	+\$38	* CEK2	* CEL2	SCEH2	N/A	SCMD	N/A	SFS2	SBM2	+\$66
48"	24"	22	\$370	* TM2	+\$38	* CEK2	* CEL2	SCEH2	N/A	SCMD	N/A	SFS2	SBM2	+\$66
48"	30"	26	\$455	* TM2	+\$38	* CEK2	* CEL2	SCEH2	N/A	SCMD	N/A	SFS2	SBM2	+\$66
54"	12"	13	\$330	* TM2	+\$38	* CEK2	* CEL2	SCEH2	N/A	SCMD	N/A	SFS2	SBM2	+\$66
54"	16"	17	\$390	* TM2	+\$38	* CEK2	* CEL2	SCEH2	N/A	SCMD	N/A	SFS2	SBM2	+\$66
54"	18"	19	\$495	* TM2	+\$38	* CEK2	* CEL2	SCEH2	N/A	SCMD	N/A	SFS2	SBM2	+\$66
54"	24"	24	\$515	* TM2	+\$38	* CEK2	* CEL2	SCEH2	N/A	SCMD	N/A	SFS2	SBM2	+\$66
54"	30"	29	\$895	* TM2	+\$38	* CEK2	* CEL2	SCEH2	N/A	SCMD	N/A	SFS2	SBM2	+\$66
60"	12"	15	\$340	* TM3	+\$57	* CEK3	* CEL3	SCEH3	N/A	SCMDP	N/A	SFS2P	SBM3	+\$99
60"	16"	19	\$405	* TM3	+\$57	* CEK3	* CEL3	SCEH3	N/A	SCMDP	N/A	SFS2P	SBM3	+\$99
60"	18"	21	\$510	* TM3	+\$57	* CEK3	* CEL3	SCEH3	N/A	SCMDP	N/A	SFS2P	SBM3	+\$99
60"	24"	27	\$530	* TM3	+\$57	* CEK3	* CEL3	SCEH3	N/A	SCMDP	N/A	SFS2P	SBM3	+\$99
60"	30"	33	\$910	* TM3	+\$57	* CEK3	* CEL3	SCEH3	N/A	SCMDP	N/A	SFS2P	SBM3	+\$99
66"	12"	17	\$355	* TM3	+\$57	* CEK3	* CEL3	SCEH3	N/A	SCMDP	N/A	SFS2P	SBM3	+\$99
66"	16"	21	\$420	* TM3	+\$57	* CEK3	* CEL3	SCEH3	N/A	SCMDP	N/A	SFS2P	SBM3	+\$99
66"	18"	23	\$525	* TM3	+\$57	* CEK3	* CEL3	SCEH3	N/A	SCMDP	N/A	SFS2P	SBM3	+\$99
66"	24"	30	\$545	* TM3	+\$57	* CEK3	* CEL3	SCEH3	N/A	SCMDP	N/A	SFS2P	SBM3	+\$99
66"	30"	36	\$925	* TM3	+\$57	* CEK3	* CEL3	SCEH3	N/A	SCMDP	N/A	SFS2P	SBM3	+\$99
72"	12"	18	\$385	* TM3	+\$57	* CEK3	* CEL3	SCEH3	N/A	SCMDP	N/A	SFS2P	SBM3	+\$99
72"	16"	23	\$455	* TM3	+\$57	* CEK3	* CEL3	SCEH3	N/A	SCMDP	N/A	SFS2P	SBM3	+\$99
72"	18"	25	\$570	* TM3	+\$57	* CEK3	* CEL3	SCEH3	N/A	SCMDP	N/A	SFS2P	SBM3	+\$99
72"	24"	32	\$595	* TM3	+\$57	* CEK3	* CEL3	SCEH3	N/A	SCMDP	N/A	SFS2P	SBM3	+\$99
72"	30"	39	\$1045	* TM3	+\$57	* CEK3	* CEL3	SCEH3	N/A	SCMDP	N/A	SFS2P	SBM3	+\$99

NOTE:

All pricing in USD

* Dimension is 1" less than width of desk to allow for rear panel

Quantity of mounting clamps noted as last number in SKU

Middle Clamp Double (SCMD) includes 2 clamps

Middle Clamp (SCMS) and Middle Clamp Knob (SCMKS) kits include 1 clamp and 1 metal stability plate

Middle Clamp Double with Pad (SCMDP) for panel widths 54" and larger, includes 2 clamps and 1 stability plate

FABRIC FOLD

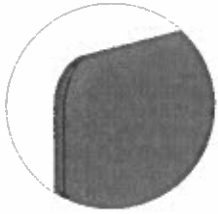

DESK DIVIDER
Style - Fabric Fold
(FF)

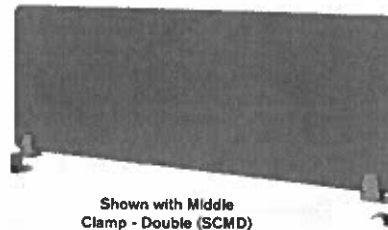

Shown with Middle
Clamp - Double (SCMD)



ALLSTATE
OFFICE INTERIORS

* Clamps available in
Silver (S) or Black (B)

MOUNTING OPTIONS

FAD-FF

Width	Height	Weight (lbs)	100 Series	200 Series	Top Mount	Price	Edge Clamp Knob	Edge Clamp Lever	Edge Clamp Hex	Middle Clamp	Middle Clamp Double	Middle Clamp Knob	Free Standing	Bench Mount	Price
17"	12"	4	\$145	\$155	* TM2	+\$38	* CEK2	* CEL2	SCEH2	SCMS	SCMD	SCMKS	SFS2	SBM2	+\$66
17"	16"	5	\$165	\$180	* TM2	+\$38	* CEK2	* CEL2	SCEH2	SCMS	SCMD	SCMKS	SFS2	SBM2	+\$66
17"	18"	5	\$195	\$220	* TM2	+\$38	* CEK2	* CEL2	SCEH2	SCMS	SCMD	SCMKS	SFS2	SBM2	+\$66
17"	24"	6	\$210	\$230	* TM2	+\$38	* CEK2	* CEL2	SCEH2	SCMS	SCMD	SCMKS	SFS2	SBM2	+\$66
17"	30"	7	\$285	\$335	* TM2	+\$38	* CEK2	* CEL2	SCEH2	SCMS	SCMD	SCMKS	SFS2	SBM2	+\$66
23"	12"	5	\$165	\$180	* TM2	+\$38	* CEK2	* CEL2	SCEH2	SCMS	SCMD	SCMKS	SFS2	SBM2	+\$66
23"	16"	6	\$195	\$210	* TM2	+\$38	* CEK2	* CEL2	SCEH2	SCMS	SCMD	SCMKS	SFS2	SBM2	+\$66
23"	18"	6	\$220	\$250	* TM2	+\$38	* CEK2	* CEL2	SCEH2	SCMS	SCMD	SCMKS	SFS2	SBM2	+\$66
23"	24"	7	\$245	\$270	* TM2	+\$38	* CEK2	* CEL2	SCEH2	SCMS	SCMD	SCMKS	SFS2	SBM2	+\$66
23"	30"	9	\$330	\$395	* TM2	+\$38	* CEK2	* CEL2	SCEH2	SCMS	SCMD	SCMKS	SFS2	SBM2	+\$66
29"	12"	6	\$190	\$205	* TM2	+\$38	* CEK2	* CEL2	SCEH2	SCMS	SCMD	SCMKS	SFS2	SBM2	+\$66
29"	16"	7	\$220	\$240	* TM2	+\$38	* CEK2	* CEL2	SCEH2	SCMS	SCMD	SCMKS	SFS2	SBM2	+\$66
29"	18"	7	\$255	\$285	* TM2	+\$38	* CEK2	* CEL2	SCEH2	SCMS	SCMD	SCMKS	SFS2	SBM2	+\$66
29"	24"	9	\$285	\$315	* TM2	+\$38	* CEK2	* CEL2	SCEH2	SCMS	SCMD	SCMKS	SFS2	SBM2	+\$66
29"	30"	10	\$430	\$505	* TM2	+\$38	* CEK2	* CEL2	SCEH2	SCMS	SCMD	SCMKS	SFS2	SBM2	+\$66
36"	12"	6	\$215	\$235	* TM2	+\$38	* CEK2	* CEL2	SCEH2	N/A	SCMD	N/A	SFS2	SBM2	+\$66
36"	16"	8	\$255	\$285	* TM2	+\$38	* CEK2	* CEL2	SCEH2	N/A	SCMD	N/A	SFS2	SBM2	+\$66
36"	18"	5	\$315	\$355	* TM2	+\$38	* CEK2	* CEL2	SCEH2	N/A	SCMD	N/A	SFS2	SBM2	+\$66
36"	24"	10	\$335	\$375	* TM2	+\$38	* CEK2	* CEL2	SCEH2	N/A	SCMD	N/A	SFS2	SBM2	+\$66
36"	30"	12	\$480	\$575	* TM2	+\$38	* CEK2	* CEL2	SCEH2	N/A	SCMD	N/A	SFS2	SBM2	+\$66
42"	12"	7	\$235	\$260	* TM2	+\$38	* CEK2	* CEL2	SCEH2	N/A	SCMD	N/A	SFS2	SBM2	+\$66
42"	16"	8	\$285	\$315	* TM2	+\$38	* CEK2	* CEL2	SCEH2	N/A	SCMD	N/A	SFS2	SBM2	+\$66
42"	18"	9	\$340	\$385	* TM2	+\$38	* CEK2	* CEL2	SCEH2	N/A	SCMD	N/A	SFS2	SBM2	+\$66
42"	24"	11	\$375	\$425	* TM2	+\$38	* CEK2	* CEL2	SCEH2	N/A	SCMD	N/A	SFS2	SBM2	+\$66
42"	30"	14	\$525	\$640	* TM2	+\$38	* CEK2	* CEL2	SCEH2	N/A	SCMD	N/A	SFS2	SBM2	+\$66
48"	12"	8	\$260	\$285	* TM2	+\$38	* CEK2	* CEL2	SCEH2	N/A	SCMD	N/A	SFS2	SBM2	+\$66
48"	16"	9	\$310	\$345	* TM2	+\$38	* CEK2	* CEL2	SCEH2	N/A	SCMD	N/A	SFS2	SBM2	+\$66
48"	18"	10	\$365	\$420	* TM2	+\$38	* CEK2	* CEL2	SCEH2	N/A	SCMD	N/A	SFS2	SBM2	+\$66
48"	24"	13	\$405	\$460	* TM2	+\$38	* CEK2	* CEL2	SCEH2	N/A	SCMD	N/A	SFS2	SBM2	+\$66
48"	30"	15	\$575	\$700	* TM2	+\$38	* CEK2	* CEL2	SCEH2	N/A	SCMD	N/A	SFS2	SBM2	+\$66
54"	12"	8	\$285	\$315	* TM2	+\$38	* CEK2	* CEL2	SCEH2	N/A	SCMD	N/A	SFS2	SBM2	+\$66
54"	16"	10	\$345	\$385	* TM2	+\$38	* CEK2	* CEL2	SCEH2	N/A	SCMD	N/A	SFS2	SBM2	+\$66
54"	18"	12	\$425	\$490	* TM2	+\$38	* CEK2	* CEL2	SCEH2	N/A	SCMD	N/A	SFS2	SBM2	+\$66
54"	24"	14	\$455	\$515	* TM2	+\$38	* CEK2	* CEL2	SCEH2	N/A	SCMD	N/A	SFS2	SBM2	+\$66
54"	30"	17	\$720	\$860	* TM2	+\$38	* CEK2	* CEL2	SCEH2	N/A	SCMD	N/A	SFS2	SBM2	+\$66
60"	12"	10	\$305	\$335	* TM3	+\$57	* CEK3	* CEL3	SCEH3	N/A	SCMDP	N/A	SFS2P	SBM3	+\$99
60"	16"	12	\$365	\$410	* TM3	+\$57	* CEK3	* CEL3	SCEH3	N/A	SCMDP	N/A	SFS2P	SBM3	+\$99
60"	18"	13	\$450	\$520	* TM3	+\$57	* CEK3	* CEL3	SCEH3	N/A	SCMDP	N/A	SFS2P	SBM3	+\$99
60"	24"	16	\$485	\$550	* TM3	+\$57	* CEK3	* CEL3	SCEH3	N/A	SCMDP	N/A	SFS2P	SBM3	+\$99
60"	30"	19	\$765	\$920	* TM3	+\$57	* CEK3	* CEL3	SCEH3	N/A	SCMDP	N/A	SFS2P	SBM3	+\$99
66"	12"	11	\$360	\$395	* TM3	+\$57	* CEK3	* CEL3	SCEH3	N/A	SCMDP	N/A	SFS2P	SBM3	+\$99
66"	16"	13	\$435	\$480	* TM3	+\$57	* CEK3	* CEL3	SCEH3	N/A	SCMDP	N/A	SFS2P	SBM3	+\$99
66"	18"	14	\$555	\$625	* TM3	+\$57	* CEK3	* CEL3	SCEH3	N/A	SCMDP	N/A	SFS2P	SBM3	+\$99
66"	24"	18	\$585	\$660	* TM3	+\$57	* CEK3	* CEL3	SCEH3	N/A	SCMDP	N/A	SFS2P	SBM3	+\$99
66"	30"	21	\$955	\$1125	* TM3	+\$57	* CEK3	* CEL3	SCEH3	N/A	SCMDP	N/A	SFS2P	SBM3	+\$99
72"	12"	11	\$395	\$435	* TM3	+\$57	* CEK3	* CEL3	SCEH3	N/A	SCMDP	N/A	SFS2P	SBM3	+\$99
72"	16"	14	\$480	\$535	* TM3	+\$57	* CEK3	* CEL3	SCEH3	N/A	SCMDP	N/A	SFS2P	SBM3	+\$99
72"	18"	15	\$615	\$695	* TM3	+\$57	* CEK3	* CEL3	SCEH3	N/A	SCMDP	N/A	SFS2P	SBM3	+\$99
72"	24"	19	\$655	\$730	* TM3	+\$57	* CEK3	* CEL3	SCEH3	N/A	SCMDP	N/A	SFS2P	SBM3	+\$99
72"	30"	23	\$1000	\$1185	* TM3	+\$57	* CEK3	* CEL3	SCEH3	N/A	SCMDP	N/A	SFS2P	SBM3	+\$99

NOTE:

All pricing in USD

Quantity of mounting clamps noted as last number in SKU

Middle Clamp (SCMS) and Middle Clamp Knob (SCMKS) kits include 1 clamp and 1 metal stability plate

* Dimension is 1" less than width of desk to allow for rear panel

Middle Clamp Double (SCMD) includes 2 clamps

Middle Clamp Double with Pad (SCMDP) for panel widths 54" and larger, includes 2 clamps and 1 stability plate

EDGE BAND

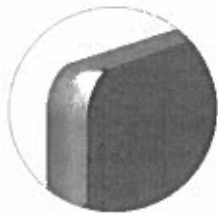

DESK DIVIDER
Style - Edge Band
(EB)

Edge Band available in:
Silver (SV)
Black (BK)
White (WT)



Shown with Top Mount (STM)



ALLSTATE
OFFICE INTERIORS

* Clamps available in
Silver (S) or Black (B)

MOUNTING OPTIONS

FAD-EB2

Width	Height	Weight (lbs)	100 Series	200 Series	Top Mount	Price	Edge Clamp Knob	Edge Clamp Lever	Edge Clamp Hex	Middle Clamp	Middle Clamp Double	Middle Clamp Knob	Free Standing	Bench Mount	Price
17"	12"	4	\$135	\$145	* TM2	+\$38	* CEK2	* CEL2	SCEH2	SCMS	SCMD	SCMKS	SFS2	SBM2	+\$66
17"	16"	5	\$155	\$170	* TM2	+\$38	* CEK2	* CEL2	SCEH2	SCMS	SCMD	SCMKS	SFS2	SBM2	+\$66
17"	18"	5	\$180	\$200	* TM2	+\$38	* CEK2	* CEL2	SCEH2	SCMS	SCMD	SCMKS	SFS2	SBM2	+\$66
17"	24"	6	\$195	\$215	* TM2	+\$38	* CEK2	* CEL2	SCEH2	SCMS	SCMD	SCMKS	SFS2	SBM2	+\$66
17"	30"	7	\$260	\$305	* TM2	+\$38	* CEK2	* CEL2	SCEH2	SCMS	SCMD	SCMKS	SFS2	SBM2	+\$66
23"	12"	5	\$155	\$170	* TM2	+\$38	* CEK2	* CEL2	SCEH2	SCMS	SCMD	SCMKS	SFS2	SBM2	+\$66
23"	16"	6	\$180	\$200	* TM2	+\$38	* CEK2	* CEL2	SCEH2	SCMS	SCMD	SCMKS	SFS2	SBM2	+\$66
23"	18"	6	\$210	\$235	* TM2	+\$38	* CEK2	* CEL2	SCEH2	SCMS	SCMD	SCMKS	SFS2	SBM2	+\$66
23"	24"	8	\$230	\$260	* TM2	+\$38	* CEK2	* CEL2	SCEH2	SCMS	SCMD	SCMKS	SFS2	SBM2	+\$66
23"	30"	9	\$305	\$360	* TM2	+\$38	* CEK2	* CEL2	SCEH2	SCMS	SCMD	SCMKS	SFS2	SBM2	+\$66
29"	12"	6	\$180	\$195	* TM2	+\$38	* CEK2	* CEL2	SCEH2	SCMS	SCMD	SCMKS	SFS2	SBM2	+\$66
29"	16"	7	\$210	\$230	* TM2	+\$38	* CEK2	* CEL2	SCEH2	SCMS	SCMD	SCMKS	SFS2	SBM2	+\$66
29"	18"	7	\$240	\$275	* TM2	+\$38	* CEK2	* CEL2	SCEH2	SCMS	SCMD	SCMKS	SFS2	SBM2	+\$66
29"	24"	9	\$265	\$300	* TM2	+\$38	* CEK2	* CEL2	SCEH2	SCMS	SCMD	SCMKS	SFS2	SBM2	+\$66
29"	30"	11	\$390	\$460	* TM2	+\$38	* CEK2	* CEL2	SCEH2	SCMS	SCMD	SCMKS	SFS2	SBM2	+\$66
36"	12"	7	\$200	\$220	* TM2	+\$38	* CEK2	* CEL2	SCEH2	N/A	SCMD	N/A	SFS2	SBM2	+\$66
36"	16"	8	\$240	\$270	* TM2	+\$38	* CEK2	* CEL2	SCEH2	N/A	SCMD	N/A	SFS2	SBM2	+\$66
36"	18"	9	\$295	\$335	* TM2	+\$38	* CEK2	* CEL2	SCEH2	N/A	SCMD	N/A	SFS2	SBM2	+\$66
36"	24"	11	\$315	\$355	* TM2	+\$38	* CEK2	* CEL2	SCEH2	N/A	SCMD	N/A	SFS2	SBM2	+\$66
36"	30"	13	\$440	\$525	* TM2	+\$38	* CEK2	* CEL2	SCEH2	N/A	SCMD	N/A	SFS2	SBM2	+\$66
42"	12"	7	\$220	\$245	* TM2	+\$38	* CEK2	* CEL2	SCEH2	N/A	SCMD	N/A	SFS2	SBM2	+\$66
42"	16"	9	\$265	\$300	* TM2	+\$38	* CEK2	* CEL2	SCEH2	N/A	SCMD	N/A	SFS2	SBM2	+\$66
42"	18"	10	\$315	\$365	* TM2	+\$38	* CEK2	* CEL2	SCEH2	N/A	SCMD	N/A	SFS2	SBM2	+\$66
42"	24"	12	\$355	\$400	* TM2	+\$38	* CEK2	* CEL2	SCEH2	N/A	SCMD	N/A	SFS2	SBM2	+\$66
42"	30"	15	\$480	\$580	* TM2	+\$38	* CEK2	* CEL2	SCEH2	N/A	SCMD	N/A	SFS2	SBM2	+\$66
48"	12"	8	\$240	\$270	* TM2	+\$38	* CEK2	* CEL2	SCEH2	N/A	SCMD	N/A	SFS2	SBM2	+\$66
48"	16"	10	\$290	\$330	* TM2	+\$38	* CEK2	* CEL2	SCEH2	N/A	SCMD	N/A	SFS2	SBM2	+\$66
48"	18"	11	\$340	\$395	* TM2	+\$38	* CEK2	* CEL2	SCEH2	N/A	SCMD	N/A	SFS2	SBM2	+\$66
48"	24"	13	\$380	\$435	* TM2	+\$38	* CEK2	* CEL2	SCEH2	N/A	SCMD	N/A	SFS2	SBM2	+\$66
48"	30"	16	\$525	\$635	* TM2	+\$38	* CEK2	* CEL2	SCEH2	N/A	SCMD	N/A	SFS2	SBM2	+\$66
54"	12"	9	\$265	\$295	* TM2	+\$38	* CEK2	* CEL2	SCEH2	N/A	SCMD	N/A	SFS2	SBM2	+\$66
54"	16"	11	\$320	\$360	* TM2	+\$38	* CEK2	* CEL2	SCEH2	N/A	SCMD	N/A	SFS2	SBM2	+\$66
54"	18"	12	\$395	\$460	* TM2	+\$38	* CEK2	* CEL2	SCEH2	N/A	SCMD	N/A	SFS2	SBM2	+\$66
54"	24"	15	\$430	\$490	* TM2	+\$38	* CEK2	* CEL2	SCEH2	N/A	SCMD	N/A	SFS2	SBM2	+\$66
54"	30"	18	\$655	\$780	* TM2	+\$38	* CEK2	* CEL2	SCEH2	N/A	SCMD	N/A	SFS2	SBM2	+\$66
60"	12"	10	\$285	\$315	* TM3	+\$57	* CEK3	* CEL3	SCEH3	N/A	SCMDP	N/A	SFS2P	SBM3	+\$99
60"	16"	13	\$340	\$385	* TM3	+\$57	* CEK3	* CEL3	SCEH3	N/A	SCMDP	N/A	SFS2P	SBM3	+\$99
60"	18"	14	\$420	\$490	* TM3	+\$57	* CEK3	* CEL3	SCEH3	N/A	SCMDP	N/A	SFS2P	SBM3	+\$99
60"	24"	17	\$455	\$520	* TM3	+\$57	* CEK3	* CEL3	SCEH3	N/A	SCMDP	N/A	SFS2P	SBM3	+\$99
60"	30"	21	\$700	\$835	* TM3	+\$57	* CEK3	* CEL3	SCEH3	N/A	SCMDP	N/A	SFS2P	SBM3	+\$99
66"	12"	11	\$320	\$360	* TM3	+\$57	* CEK3	* CEL3	SCEH3	N/A	SCMDP	N/A	SFS2P	SBM3	+\$99
66"	16"	14	\$390	\$440	* TM3	+\$57	* CEK3	* CEL3	SCEH3	N/A	SCMDP	N/A	SFS2P	SBM3	+\$99
66"	18"	15	\$495	\$565	* TM3	+\$57	* CEK3	* CEL3	SCEH3	N/A	SCMDP	N/A	SFS2P	SBM3	+\$99
66"	24"	19	\$530	\$605	* TM3	+\$57	* CEK3	* CEL3	SCEH3	N/A	SCMDP	N/A	SFS2P	SBM3	+\$99
66"	30"	22	\$890	\$1045	* TM3	+\$57	* CEK3	* CEL3	SCEH3	N/A	SCMDP	N/A	SFS2P	SBM3	+\$99
72"	12"	12	\$340	\$380	* TM3	+\$57	* CEK3	* CEL3	SCEH3	N/A	SCMDP	N/A	SFS2P	SBM3	+\$99
72"	16"	14	\$410	\$465	* TM3	+\$57	* CEK3	* CEL3	SCEH3	N/A	SCMDP	N/A	SFS2P	SBM3	+\$99
72"	18"	16	\$520	\$600	* TM3	+\$57	* CEK3	* CEL3	SCEH3	N/A	SCMDP	N/A	SFS2P	SBM3	+\$99
72"	24"	20	\$555	\$635	* TM3	+\$57	* CEK3	* CEL3	SCEH3	N/A	SCMDP	N/A	SFS2P	SBM3	+\$99
72"	30"	24	\$1100	\$1100	* TM3	+\$57	* CEK3	* CEL3	SCEH3	N/A	SCMDP	N/A	SFS2P	SBM3	+\$99

NOTE:

All pricing in USD

* Dimension is 1" less than width of desk to allow for rear panel

Quantity of mounting clamps noted as last number in SKU

Middle Clamp Double (SCMD) includes 2 clamps

Middle Clamp (SCMS) and Middle Clamp Knob (SCMKS) kits include 1 clamp and 1 metal stability plate

Middle Clamp Double with Pad (SCMDP) for panel widths 54" and larger, includes 2 clamps and 1 stability plate

METAL TRIM

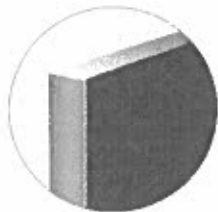

DESK DIVIDER
Style - Metal Trim
(MT)

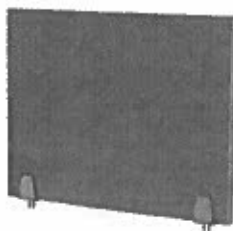

Shown with Top Mount (STM)



ALLSTATE
OFFICE INTERIORS

* Clamps available in Silver (S) or Black (B)

MOUNTING OPTIONS

FAD-MT2					MOUNTING OPTIONS										
Width	Height	Weight (lbs)	100 Series	200 Series	Top Mount	Price	Edge Clamp Knob	Edge Clamp Lever	Edge Clamp Hex	Middle Clamp	Middle Clamp Double	Middle Clamp Knob	Free Standing	Bench Mount	Price
17"	12"	5	\$145	\$155	*TM2	+\$38	*CEK2	*CEL2	SCEH2	SCMS	SCMD	SCMKS	SFS2	SBM2	+\$66
17"	16"	5	\$165	\$180	*TM2	+\$38	*CEK2	*CEL2	SCEH2	SCMS	SCMD	SCMKS	SFS2	SBM2	+\$66
17"	18"	6	\$190	\$210	*TM2	+\$38	*CEK2	*CEL2	SCEH2	SCMS	SCMD	SCMKS	SFS2	SBM2	+\$66
17"	24"	7	\$205	\$225	*TM2	+\$38	*CEK2	*CEL2	SCEH2	SCMS	SCMD	SCMKS	SFS2	SBM2	+\$66
17"	30"	8	\$275	\$320	*TM2	+\$38	*CEK2	*CEL2	SCEH2	SCMS	SCMD	SCMKS	SFS2	SBM2	+\$66
23"	12"	5	\$165	\$180	*TM2	+\$38	*CEK2	*CEL2	SCEH2	SCMS	SCMD	SCMKS	SFS2	SBM2	+\$66
23"	16"	6	\$195	\$210	*TM2	+\$38	*CEK2	*CEL2	SCEH2	SCMS	SCMD	SCMKS	SFS2	SBM2	+\$66
23"	18"	7	\$220	\$250	*TM2	+\$38	*CEK2	*CEL2	SCEH2	SCMS	SCMD	SCMKS	SFS2	SBM2	+\$66
23"	24"	8	\$245	\$270	*TM2	+\$38	*CEK2	*CEL2	SCEH2	SCMS	SCMD	SCMKS	SFS2	SBM2	+\$66
23"	30"	10	\$320	\$375	*TM2	+\$38	*CEK2	*CEL2	SCEH2	SCMS	SCMD	SCMKS	SFS2	SBM2	+\$66
29"	12"	6	\$190	\$205	*TM2	+\$38	*CEK2	*CEL2	SCEH2	SCMS	SCMD	SCMKS	SFS2	SBM2	+\$66
29"	16"	7	\$220	\$240	*TM2	+\$38	*CEK2	*CEL2	SCEH2	SCMS	SCMD	SCMKS	SFS2	SBM2	+\$66
29"	18"	8	\$255	\$285	*TM2	+\$38	*CEK2	*CEL2	SCEH2	SCMS	SCMD	SCMKS	SFS2	SBM2	+\$66
29"	24"	10	\$285	\$315	*TM2	+\$38	*CEK2	*CEL2	SCEH2	SCMS	SCMD	SCMKS	SFS2	SBM2	+\$66
29"	30"	12	\$410	\$475	*TM2	+\$38	*CEK2	*CEL2	SCEH2	SCMS	SCMD	SCMKS	SFS2	SBM2	+\$66
36"	12"	7	\$215	\$235	*TM2	+\$38	*CEK2	*CEL2	SCEH2	N/A	SCMD	N/A	SFS2	SBM2	+\$66
36"	16"	8	\$255	\$280	*TM2	+\$38	*CEK2	*CEL2	SCEH2	N/A	SCMD	N/A	SFS2	SBM2	+\$66
36"	18"	9	\$305	\$350	*TM2	+\$38	*CEK2	*CEL2	SCEH2	N/A	SCMD	N/A	SFS2	SBM2	+\$66
36"	24"	11	\$330	\$370	*TM2	+\$38	*CEK2	*CEL2	SCEH2	N/A	SCMD	N/A	SFS2	SBM2	+\$66
36"	30"	14	\$460	\$545	*TM2	+\$38	*CEK2	*CEL2	SCEH2	N/A	SCMD	N/A	SFS2	SBM2	+\$66
42"	12"	8	\$235	\$260	*TM2	+\$38	*CEK2	*CEL2	SCEH2	N/A	SCMD	N/A	SFS2	SBM2	+\$66
42"	16"	9	\$280	\$315	*TM2	+\$38	*CEK2	*CEL2	SCEH2	N/A	SCMD	N/A	SFS2	SBM2	+\$66
42"	18"	10	\$330	\$380	*TM2	+\$38	*CEK2	*CEL2	SCEH2	N/A	SCMD	N/A	SFS2	SBM2	+\$66
42"	24"	13	\$370	\$420	*TM2	+\$38	*CEK2	*CEL2	SCEH2	N/A	SCMD	N/A	SFS2	SBM2	+\$66
42"	30"	16	\$505	\$600	*TM2	+\$38	*CEK2	*CEL2	SCEH2	N/A	SCMD	N/A	SFS2	SBM2	+\$66
48"	12"	8	\$255	\$280	*TM2	+\$38	*CEK2	*CEL2	SCEH2	N/A	SCMD	N/A	SFS2	SBM2	+\$66
48"	16"	10	\$310	\$345	*TM2	+\$38	*CEK2	*CEL2	SCEH2	N/A	SCMD	N/A	SFS2	SBM2	+\$66
48"	18"	11	\$360	\$415	*TM2	+\$38	*CEK2	*CEL2	SCEH2	N/A	SCMD	N/A	SFS2	SBM2	+\$66
48"	24"	14	\$400	\$455	*TM2	+\$38	*CEK2	*CEL2	SCEH2	N/A	SCMD	N/A	SFS2	SBM2	+\$66
48"	30"	17	\$545	\$660	*TM2	+\$38	*CEK2	*CEL2	SCEH2	N/A	SCMD	N/A	SFS2	SBM2	+\$66
54"	12"	9	\$280	\$310	*TM2	+\$38	*CEK2	*CEL2	SCEH2	N/A	SCMD	N/A	SFS2	SBM2	+\$66
54"	16"	11	\$340	\$380	*TM2	+\$38	*CEK2	*CEL2	SCEH2	N/A	SCMD	N/A	SFS2	SBM2	+\$66
54"	18"	13	\$415	\$475	*TM2	+\$38	*CEK2	*CEL2	SCEH2	N/A	SCMD	N/A	SFS2	SBM2	+\$66
54"	24"	16	\$450	\$510	*TM2	+\$38	*CEK2	*CEL2	SCEH2	N/A	SCMD	N/A	SFS2	SBM2	+\$66
54"	30"	19	\$680	\$805	*TM2	+\$38	*CEK2	*CEL2	SCEH2	N/A	SCMD	N/A	SFS2	SBM2	+\$66
60"	12"	11	\$300	\$335	*TM3	+\$57	*CEK3	*CEL3	SCEH3	N/A	SCMDP	N/A	SFS2P	SBM3	+\$99
60"	16"	13	\$360	\$405	*TM3	+\$57	*CEK3	*CEL3	SCEH3	N/A	SCMDP	N/A	SFS2P	SBM3	+\$99
60"	18"	15	\$440	\$510	*TM3	+\$57	*CEK3	*CEL3	SCEH3	N/A	SCMDP	N/A	SFS2P	SBM3	+\$99
60"	24"	18	\$475	\$545	*TM3	+\$57	*CEK3	*CEL3	SCEH3	N/A	SCMDP	N/A	SFS2P	SBM3	+\$99
60"	30"	22	\$725	\$860	*TM3	+\$57	*CEK3	*CEL3	SCEH3	N/A	SCMDP	N/A	SFS2P	SBM3	+\$99
66"	12"	12	\$340	\$375	*TM3	+\$57	*CEK3	*CEL3	SCEH3	N/A	SCMDP	N/A	SFS2P	SBM3	+\$99
66"	16"	14	\$410	\$460	*TM3	+\$57	*CEK3	*CEL3	SCEH3	N/A	SCMDP	N/A	SFS2P	SBM3	+\$99
66"	18"	16	\$515	\$585	*TM3	+\$57	*CEK3	*CEL3	SCEH3	N/A	SCMDP	N/A	SFS2P	SBM3	+\$99
66"	24"	20	\$555	\$625	*TM3	+\$57	*CEK3	*CEL3	SCEH3	N/A	SCMDP	N/A	SFS2P	SBM3	+\$99
66"	30"	24	\$920	\$1070	*TM3	+\$57	*CEK3	*CEL3	SCEH3	N/A	SCMDP	N/A	SFS2P	SBM3	+\$99
72"	12"	12	\$355	\$395	*TM3	+\$57	*CEK3	*CEL3	SCEH3	N/A	SCMDP	N/A	SFS2P	SBM3	+\$99
72"	16"	15	\$430	\$485	*TM3	+\$57	*CEK3	*CEL3	SCEH3	N/A	SCMDP	N/A	SFS2P	SBM3	+\$99
72"	18"	17	\$540	\$620	*TM3	+\$57	*CEK3	*CEL3	SCEH3	N/A	SCMDP	N/A	SFS2P	SBM3	+\$99
72"	24"	21	\$580	\$660	*TM3	+\$57	*CEK3	*CEL3	SCEH3	N/A	SCMDP	N/A	SFS2P	SBM3	+\$99
72"	30"	26	\$960	\$1125	*TM3	+\$57	*CEK3	*CEL3	SCEH3	N/A	SCMDP	N/A	SFS2P	SBM3	+\$99

NOTE:

All pricing in USD

Quantity of mounting clamps noted as last number in SKU

Middle Clamp (SCMS) and Middle Clamp Knob (SCMKS) kits include 1 clamp and 1 metal stability plate

* Dimension is 1" less than width of desk to allow for rear panel

Middle Clamp Double (SCMD) includes 2 clamps

Middle Clamp Double with Pad (SCMDP) for panel widths 54" and larger, includes 2 clamps and 1 stability plate

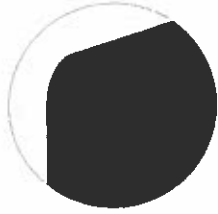

DESK DIVIDER
Style - EchoScape™
(PE18)

3/4" (18mm) thickness

See pages 12-13 for
Banner Design Cutout
Options

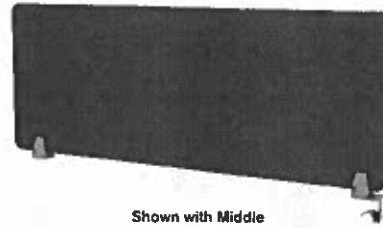

Shown with Middle
Clamp - Single (SCMS)

* Clamps available in
Silver (S) or Black (B)

MOUNTING OPTIONS

FAD-PE18					MOUNTING OPTIONS												
Width	Height	Weight (lbs)	Base Price	Banner Design Cutout (optional)	Top Mount	Price	Edge Clamp Knob	Edge Clamp Lever	Edge Clamp Hex	Middle Clamp	Middle Clamp Double	Middle Clamp Knob	Free Standing	Bench Mount	Price		
17"	12"	4	\$105	+\$30	* TM2	+\$38	* CEK2	* CEL2	SCEH2	SCMS	SCMD	SCMKS	SFS2	SBM2	+\$66		
17"	16"	4	\$120	+\$30	* TM2	+\$38	* CEK2	* CEL2	SCEH2	SCMS	SCMD	SCMKS	SFS2	SBM2	+\$66		
17"	18"	4	\$130	+\$30	* TM2	+\$38	* CEK2	* CEL2	SCEH2	SCMS	SCMD	SCMKS	SFS2	SBM2	+\$66		
17"	24"	5	\$150	+\$30	* TM2	+\$38	* CEK2	* CEL2	SCEH2	SCMS	SCMD	SCMKS	SFS2	SBM2	+\$66		
17"	30"	5	\$170	+\$30	* TM2	+\$38	* CEK2	* CEL2	SCEH2	SCMS	SCMD	SCMKS	SFS2	SBM2	+\$66		
23"	12"	4	\$120	+\$30	* TM2	+\$38	* CEK2	* CEL2	SCEH2	SCMS	SCMD	SCMKS	SFS2	SBM2	+\$66		
23"	16"	4	\$145	+\$30	* TM2	+\$38	* CEK2	* CEL2	SCEH2	SCMS	SCMD	SCMKS	SFS2	SBM2	+\$66		
23"	18"	5	\$150	+\$30	* TM2	+\$38	* CEK2	* CEL2	SCEH2	SCMS	SCMD	SCMKS	SFS2	SBM2	+\$66		
23"	24"	5	\$185	+\$30	* TM2	+\$38	* CEK2	* CEL2	SCEH2	SCMS	SCMD	SCMKS	SFS2	SBM2	+\$66		
23"	30"	6	\$200	+\$30	* TM2	+\$38	* CEK2	* CEL2	SCEH2	SCMS	SCMD	SCMKS	SFS2	SBM2	+\$66		
29"	12"	4	\$140	+\$40	* TM2	+\$38	* CEK2	* CEL2	SCEH2	SCMS	SCMD	SCMKS	SFS2	SBM2	+\$66		
29"	16"	5	\$160	+\$40	* TM2	+\$38	* CEK2	* CEL2	SCEH2	SCMS	SCMD	SCMKS	SFS2	SBM2	+\$66		
29"	18"	5	\$170	+\$40	* TM2	+\$38	* CEK2	* CEL2	SCEH2	SCMS	SCMD	SCMKS	SFS2	SBM2	+\$66		
29"	24"	6	\$200	+\$40	* TM2	+\$38	* CEK2	* CEL2	SCEH2	SCMS	SCMD	SCMKS	SFS2	SBM2	+\$66		
29"	30"	7	\$245	+\$40	* TM2	+\$38	* CEK2	* CEL2	SCEH2	SCMS	SCMD	SCMKS	SFS2	SBM2	+\$66		
36"	12"	5	\$160	+\$40	* TM2	+\$38	* CEK2	* CEL2	SCEH2	N/A	SCMD	N/A	SFS2	SBM2	+\$66		
36"	16"	5	\$195	+\$40	* TM2	+\$38	* CEK2	* CEL2	SCEH2	N/A	SCMD	N/A	SFS2	SBM2	+\$66		
36"	18"	6	\$210	+\$40	* TM2	+\$38	* CEK2	* CEL2	SCEH2	N/A	SCMD	N/A	SFS2	SBM2	+\$66		
36"	24"	7	\$240	+\$40	* TM2	+\$38	* CEK2	* CEL2	SCEH2	N/A	SCMD	N/A	SFS2	SBM2	+\$66		
36"	30"	8	\$300	+\$40	* TM2	+\$38	* CEK2	* CEL2	SCEH2	N/A	SCMD	N/A	SFS2	SBM2	+\$66		
42"	12"	5	\$180	+\$50	* TM2	+\$38	* CEK2	* CEL2	SCEH2	N/A	SCMD	N/A	SFS2	SBM2	+\$66		
42"	16"	6	\$205	+\$50	* TM2	+\$38	* CEK2	* CEL2	SCEH2	N/A	SCMD	N/A	SFS2	SBM2	+\$66		
42"	18"	6	\$225	+\$50	* TM2	+\$38	* CEK2	* CEL2	SCEH2	N/A	SCMD	N/A	SFS2	SBM2	+\$66		
42"	24"	8	\$300	+\$50	* TM2	+\$38	* CEK2	* CEL2	SCEH2	N/A	SCMD	N/A	SFS2	SBM2	+\$66		
42"	30"	9	\$335	+\$50	* TM2	+\$38	* CEK2	* CEL2	SCEH2	N/A	SCMD	N/A	SFS2	SBM2	+\$66		
48"	12"	5	\$200	+\$50	* TM2	+\$38	* CEK2	* CEL2	SCEH2	N/A	SCMD	N/A	SFS2	SBM2	+\$66		
48"	16"	6	\$240	+\$50	* TM2	+\$38	* CEK2	* CEL2	SCEH2	N/A	SCMD	N/A	SFS2	SBM2	+\$66		
48"	18"	7	\$265	+\$50	* TM2	+\$38	* CEK2	* CEL2	SCEH2	N/A	SCMD	N/A	SFS2	SBM2	+\$66		
48"	24"	8	\$310	+\$50	* TM2	+\$38	* CEK2	* CEL2	SCEH2	N/A	SCMD	N/A	SFS2	SBM2	+\$66		
48"	30"	10	\$415	+\$50	* TM2	+\$38	* CEK2	* CEL2	SCEH2	N/A	SCMD	N/A	SFS2	SBM2	+\$66		
54"	12"	6	\$215	+\$60	* TM2	+\$38	* CEK2	* CEL2	SCEH2	N/A	SCMD	N/A	SFS2	SBM2	+\$66		
54"	16"	7	\$255	+\$60	* TM2	+\$38	* CEK2	* CEL2	SCEH2	N/A	SCMD	N/A	SFS2	SBM2	+\$66		
54"	18"	8	\$280	+\$60	* TM2	+\$38	* CEK2	* CEL2	SCEH2	N/A	SCMD	N/A	SFS2	SBM2	+\$66		
54"	24"	9	\$325	+\$60	* TM2	+\$38	* CEK2	* CEL2	SCEH2	N/A	SCMD	N/A	SFS2	SBM2	+\$66		
54"	30"	11	\$425	+\$60	* TM2	+\$38	* CEK2	* CEL2	SCEH3	N/A	SCMD	N/A	SFS2	SBM2	+\$66		
60"	12"	7	\$225	+\$60	* TM3	+\$57	* CEK3	* CEL3	SCEH3	N/A	SCMDP	N/A	SFS2P	SBM3	+\$99		
60"	16"	8	\$265	+\$60	* TM3	+\$57	* CEK3	* CEL3	SCEH3	N/A	SCMDP	N/A	SFS2P	SBM3	+\$99		
60"	18"	9	\$290	+\$60	* TM3	+\$57	* CEK3	* CEL3	SCEH3	N/A	SCMDP	N/A	SFS2P	SBM3	+\$99		
60"	24"	11	\$340	+\$60	* TM3	+\$57	* CEK3	* CEL3	SCEH3	N/A	SCMDP	N/A	SFS2P	SBM3	+\$99		
60"	30"	13	\$435	+\$60	* TM3	+\$57	* CEK3	* CEL3	SCEH3	N/A	SCMDP	N/A	SFS2P	SBM3	+\$99		
66"	12"	8	\$280	+\$70	* TM3	+\$57	* CEK3	* CEL3	SCEH3	N/A	SCMDP	N/A	SFS2P	SBM3	+\$99		
66"	16"	9	\$370	+\$70	* TM3	+\$57	* CEK3	* CEL3	SCEH3	N/A	SCMDP	N/A	SFS2P	SBM3	+\$99		
66"	18"	10	\$375	+\$70	* TM3	+\$57	* CEK3	* CEL3	SCEH3	N/A	SCMDP	N/A	SFS2P	SBM3	+\$99		
66"	24"	12	\$490	+\$70	* TM3	+\$57	* CEK3	* CEL3	SCEH3	N/A	SCMDP	N/A	SFS2P	SBM3	+\$99		
66"	30"	14	\$530	+\$70	* TM3	+\$57	* CEK3	* CEL3	SCEH3	N/A	SCMDP	N/A	SFS2P	SBM3	+\$99		
72"	12"	8	\$290	+\$70	* TM3	+\$57	* CEK3	* CEL3	SCEH3	N/A	SCMDP	N/A	SFS2P	SBM3	+\$99		
72"	16"	9	\$380	+\$70	* TM3	+\$57	* CEK3	* CEL3	SCEH3	N/A	SCMDP	N/A	SFS2P	SBM3	+\$99		
72"	18"	10	\$390	+\$70	* TM3	+\$57	* CEK3	* CEL3	SCEH3	N/A	SCMDP	N/A	SFS2P	SBM3	+\$99		
72"	24"	12	\$505	+\$70	* TM3	+\$57	* CEK3	* CEL3	SCEH3	N/A	SCMDP	N/A	SFS2P	SBM3	+\$99		
72"	30"	15	\$540	+\$70	* TM3	+\$57	* CEK3	* CEL3	SCEH3	N/A	SCMDP	N/A	SFS2P	SBM3	+\$99		

NOTE:

All pricing in USD

Quantity of mounting clamps noted as last number in SKU

Middle Clamp (SCMS) and Middle Clamp Knob (SCMKS) kits include 1 clamp and 1 metal stability plate

Middle Clamp Double (SCMD) includes 2 clamps

* Dimension is 1" less than width of desk to allow for rear panel

Middle Clamp Double with Pad (SCMDP) for panel widths 54" and larger, includes 2 clamps and 1 stability plate

Sound Absorbent - EchoScape™ 3/4" (18mm), is rated at .9 NRC

Eco-Friendly - EchoScape™ is made from 60% post-consumer reclaimed plastic water bottles, is VOC-free, and 100% recyclable

ECHOSCAPE™ INVISIBLE MOUNT

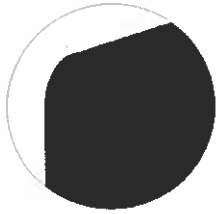

DESK DIVIDER
Style - EchoScape™
(IPE18)
3/4" (18mm) thickness

See pages 12-13 for
Banner Design Cutout
Options

MOUNTING OPTION

FAD-IPE18

Width	Height	Weight (lbs)	Base Price	Banner Design Cutout (optional)	Invisible Mount (quantity)	Price
17"	12"	4	\$105	N/A	2	+\$38
17"	16"	4	\$120	+\$30	2	+\$38
17"	18"	4	\$130	+\$30	2	+\$38
17"	24"	5	\$150	+\$30	2	+\$38
17"	30"	5	\$170	+\$30	2	+\$38
23"	12"	4	\$120	N/A	2	+\$38
23"	16"	4	\$145	+\$30	2	+\$38
23"	18"	5	\$150	+\$30	2	+\$38
23"	24"	5	\$185	+\$30	2	+\$38
23"	30"	6	\$200	+\$30	2	+\$38
29"	12"	4	\$140	N/A	2	+\$38
29"	16"	5	\$160	+\$40	2	+\$38
29"	18"	5	\$170	+\$40	2	+\$38
29"	24"	6	\$200	+\$40	2	+\$38
29"	30"	7	\$245	+\$40	2	+\$38
36"	12"	5	\$160	N/A	2	+\$38
36"	16"	5	\$195	+\$40	2	+\$38
36"	18"	6	\$210	+\$40	2	+\$38
36"	24"	7	\$240	+\$40	2	+\$38
36"	30"	8	\$300	+\$40	2	+\$38
42"	12"	5	\$180	N/A	2	+\$38
42"	16"	6	\$205	+\$50	2	+\$38
42"	18"	6	\$225	+\$50	2	+\$38
42"	24"	8	\$300	+\$50	2	+\$38
42"	30"	9	\$335	+\$50	2	+\$38
48"	12"	5	\$200	N/A	2	+\$38
48"	16"	6	\$240	+\$50	2	+\$38
48"	18"	7	\$265	+\$50	2	+\$38
48"	24"	8	\$310	+\$50	2	+\$38
48"	30"	10	\$415	+\$50	2	+\$38
54"	12"	6	\$215	N/A	2	+\$38
54"	16"	7	\$255	+\$60	2	+\$38
54"	18"	8	\$280	+\$60	2	+\$38
54"	24"	9	\$325	+\$60	2	+\$38
54"	30"	11	\$425	+\$60	2	+\$38
60"	12"	7	\$225	N/A	3	+\$57
60"	16"	8	\$265	+\$60	3	+\$57
60"	18"	9	\$290	+\$60	3	+\$57
60"	24"	11	\$340	+\$60	3	+\$57
60"	30"	13	\$435	+\$60	3	+\$57
66"	12"	8	\$280	N/A	3	+\$57
66"	16"	9	\$370	+\$70	3	+\$57
66"	18"	10	\$375	+\$70	3	+\$57
66"	24"	12	\$490	+\$70	3	+\$57
66"	30"	14	\$535	+\$70	3	+\$57
72"	12"	8	\$290	N/A	3	+\$57
72"	16"	9	\$380	+\$70	3	+\$57
72"	18"	10	\$390	+\$70	3	+\$57
72"	24"	12	\$505	+\$70	3	+\$57
72"	30"	15	\$540	+\$70	3	+\$57

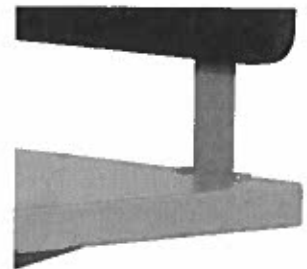
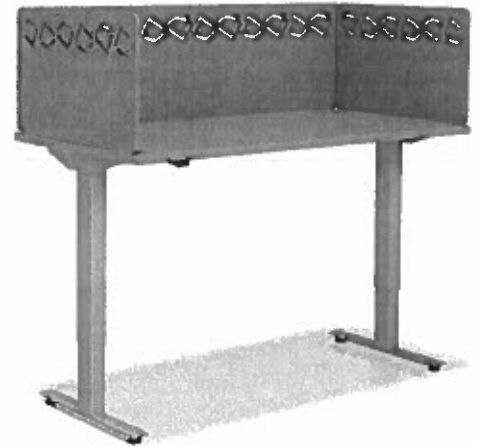

Shown with EchoScape™ Invisible Mount (IPE18)

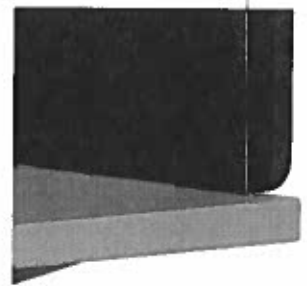

Shown with EchoScape™ Invisible Mount (IPE18)

NOTE:

All pricing in USD

* Dimension is 1" less than width of desk to allow for rear panel

Sound Absorbent - EchoScape™ 3/4" (18mm), is rated at .9 NRC

Eco-Friendly - EchoScape™ is made from 60% post-consumer reclaimed plastic water bottles, is VOC-free, and 100% recyclable

DESIGN CUTOUTS

Available in EchoScape™ (PE18) and EchoScape™ Invisible Mount (IPE18)

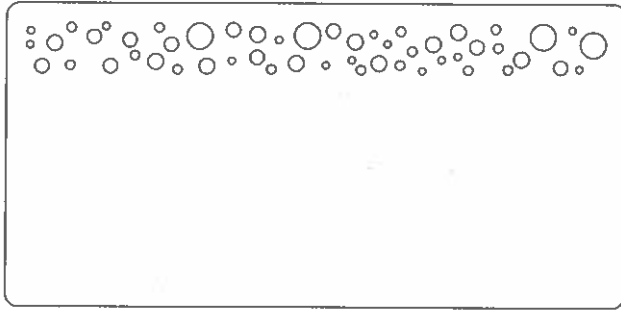

D002 - FIZZY

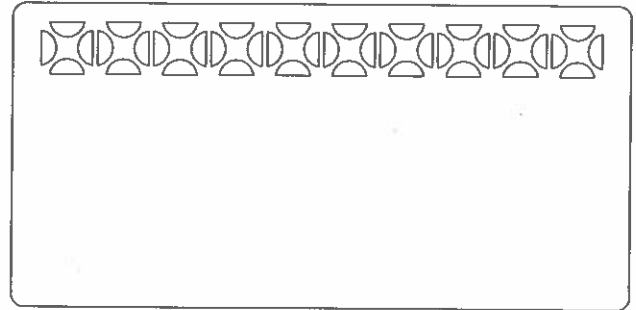

D004 - METRO

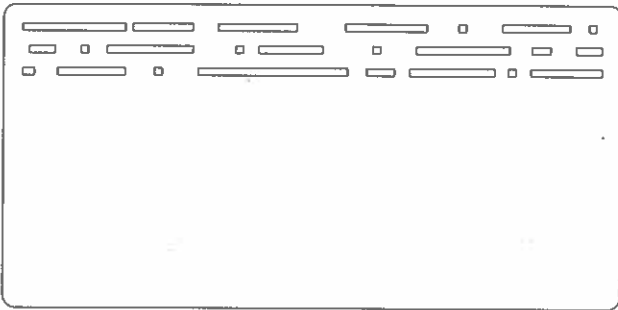

D005 - DASH

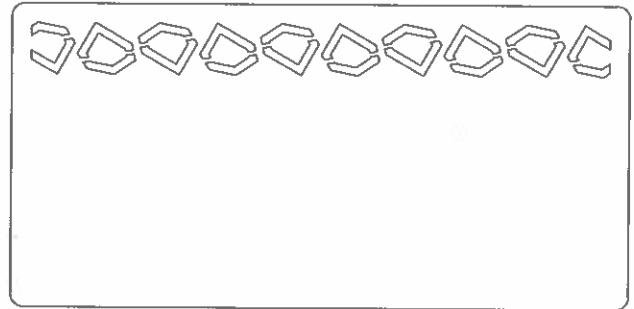

D008 - TRIBAL

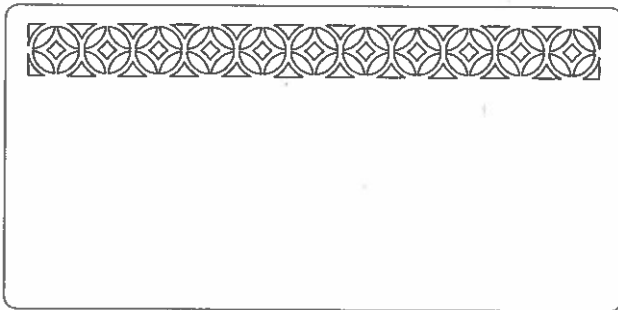

D016 - RETRO

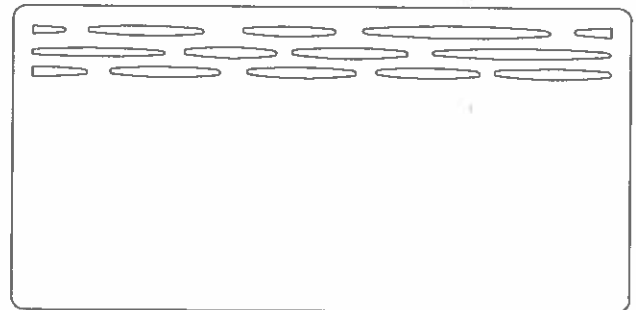

D017 - STRATA



DESIGN CUTOUTS

Available in EchoScape™ (PE18) and EchoScape™ Invisible Mount (IPE18)



ALLSTATE
OFFICE INTERIORS

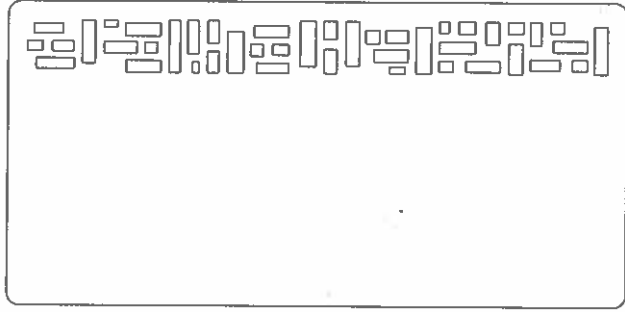

D021 - MAZE

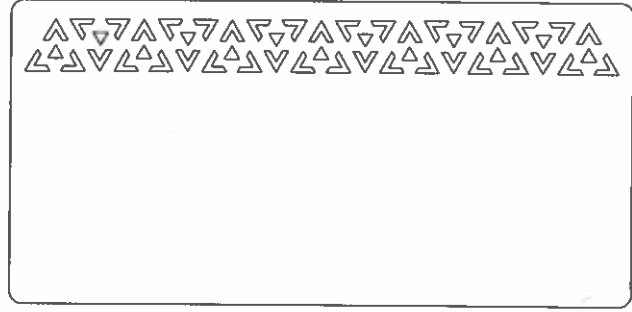

D022 - AZTEC

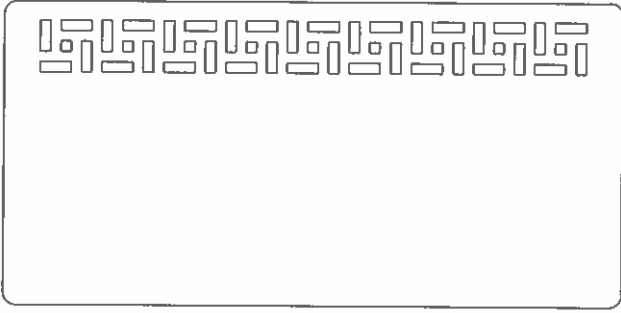

D023 - PINWHEEL

FABRIC SERIES 100 (F1_)

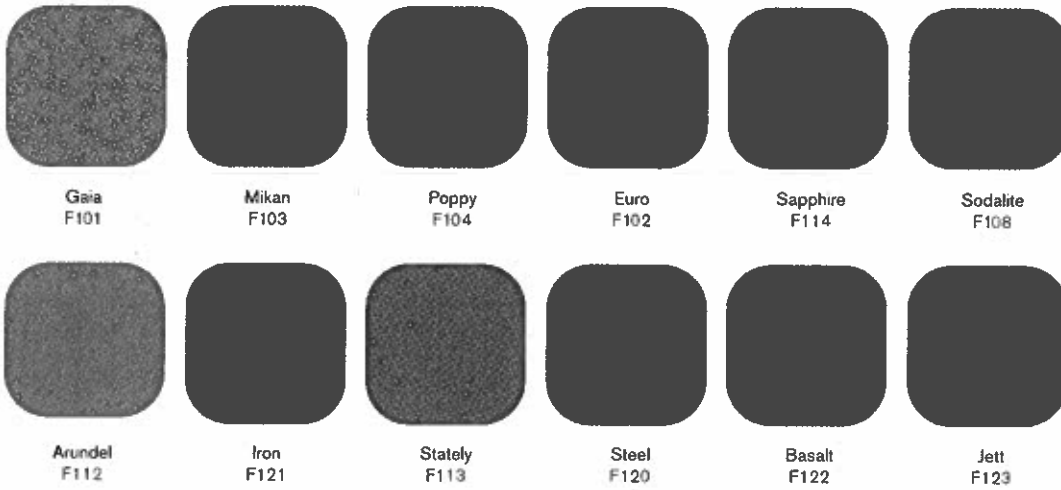

FABRIC SERIES 200 (F2_)

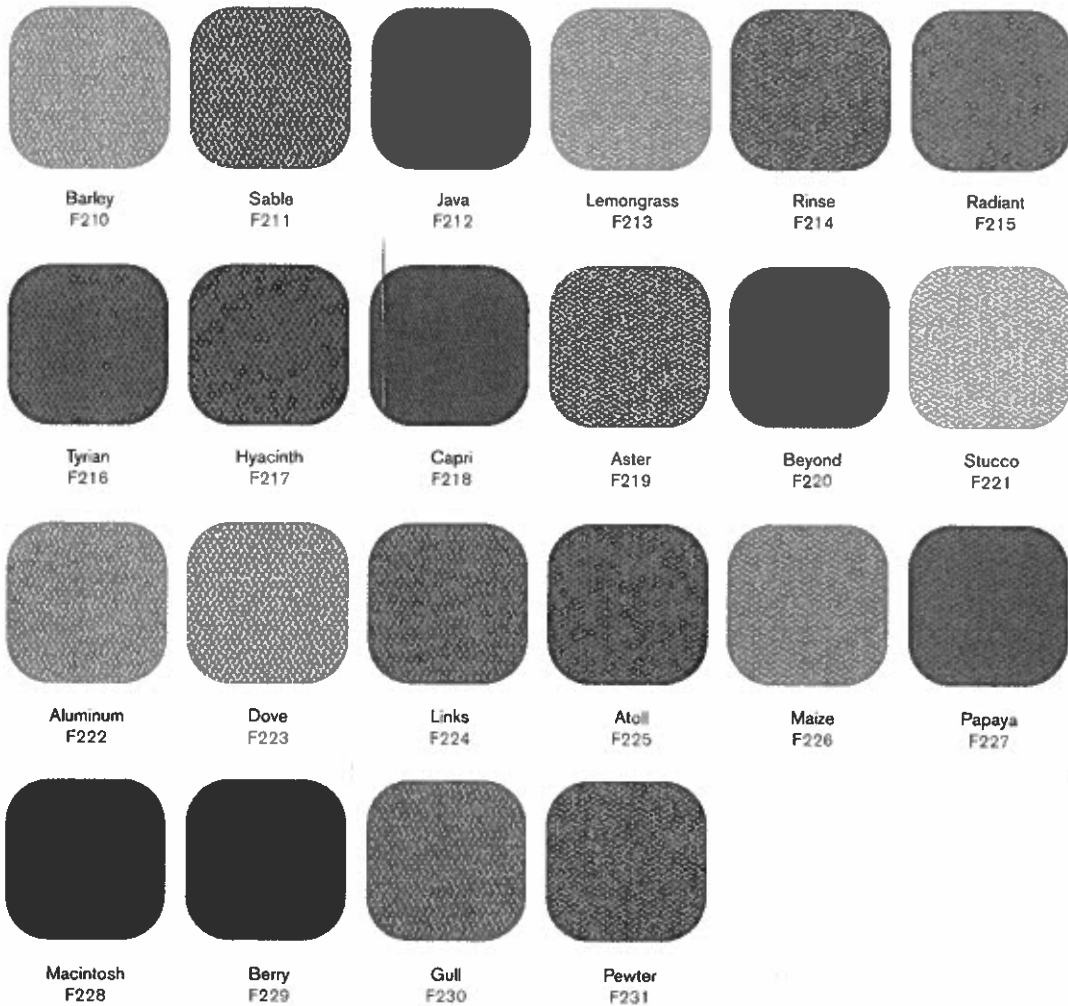



ECHOSCAPE™ 3/4" (18MM) (P1_)



Ash
P100



Charcoal
P101



Cobalt
P102



Pear
P103



Sandstone
P104



Slate
P105



Iced Grey
P106



Linen
P107

EDGE BAND COLORS



Silver
SV



Black
BK



White
WT

METAL TRIM COLOR



Satin Aluminum
AA

CUBICLE EXTENDER PANELS



Add visual and sound privacy to your existing cubicles with Panel Stackers™. Our cubicle extender panels are a cost-effective solution to add height to existing cubicle walls while updating the look and adding visual interest to your office.

Available in multiple sizes and colors in EchoScape™ or Frosted Acrylic, Stackers™ merge seamlessly with your current cubicle system. With mounting options for both flat or curved cubicle surfaces and easy installation, Stackers™ create maximum privacy at an economical cost.

- Frosted Acrylic - 0.25" thick with smooth and polished edges
- EchoScape™ acoustic solution effectively controls noise disruptions by absorbing sound
- 3/8" (9mm) and 3/4" (18mm) thickness
- NRC rated up to 0.9
- Multiple panel sizes available to match your cubicles dimensions
- Configurable and durable mounting hardware
- For installation on a flat cubicle trim surface, use either our Tower Mount or our Square Mount
- For installation on a curved cubical trim surface, use our Square Mount
- Made in the USA

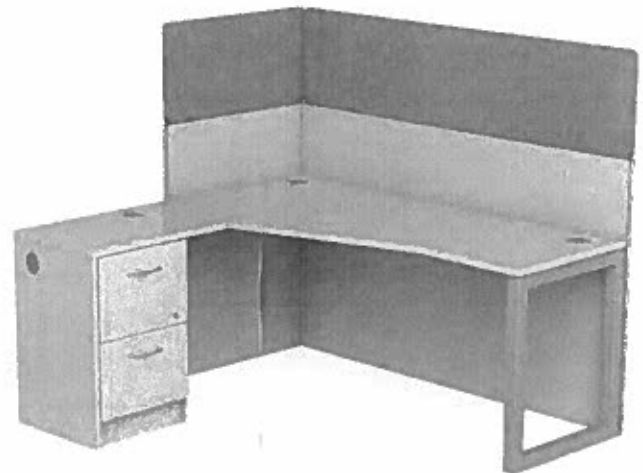

How to build your SKU:

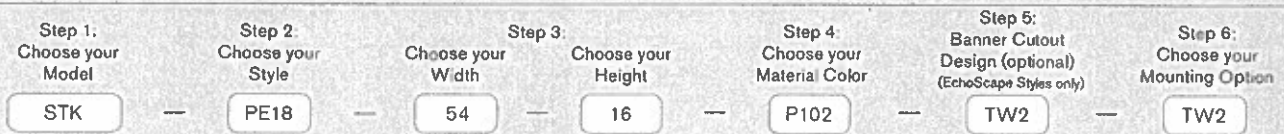

PANEL STACKERS™

Model	Style	Width	Height	Material Color	Banner Cutout Designs (optional) (EchoScape Styles only)	Mounting Options
STK Stackers™	FRO Frosted Acrylic	24"	12"	P1_ EchoScape™	D002 Fizzy	TW2 Tower Mount - 2 Clamps
	CLR Clear Acrylic	30"	16"		D004 Metro	TW4 Tower Mount - 4 Clamps
	PE18 EchoScape™ 3/4" (18mm)	36"	18"		D005 Dash	SQ2 Square Mount - 2 Clamps
	IPE18 EchoScape™ 3/4" (18mm) Invisible Mount	42"	24"		D008 Tribal	SQ4 Square Mount - 4 Clamps
	PE9 EchoScape™ 3/8" (9mm) Invisible Mount	48"	30"		D016 Retro	IM2 Invisible Mount - 2 Mounts
		54"			D017 Strata	IM4 Invisible Mount - 4 Mounts
		60"			D021 Maze	CPM2 Clamp Panel Mount 2 Mounts
		66"			D022 Aztec	CPM4 Clamp Panel Mount 4 Mounts
		72"			D023 Pinwheel	

PANEL STACKERS - FROSTED ACRYLIC



PANEL STACKERS
Frosted Acrylic
(FRO)

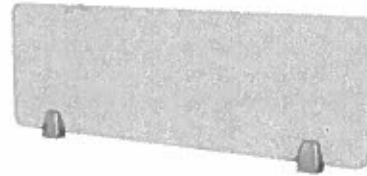

Shown with Tower Mount (TW2)

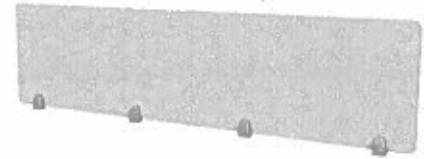

Shown with Tower Mount (TW4)

MOUNTING OPTIONS

Width	Height	STK-FRO	Tower Mount	Tower Mount	Square Mount	Square Mount	Weight (lbs)
		Price	2 Clamps (TW2)	4 Clamps (TW4)	2 Clamps (TW2)	4 Clamps (TW4)	
24"	12"	\$110	+\$38	N/A	+\$38	N/A	4
24"	16"	\$130	+\$38	N/A	+\$38	N/A	5
24"	18"	\$150	+\$38	N/A	+\$38	N/A	6
24"	24"	\$180	+\$38	N/A	+\$38	N/A	7
24"	30"	\$210	+\$38	N/A	+\$38	N/A	9
30"	12"	\$130	+\$38	N/A	+\$38	N/A	5
30"	16"	\$160	+\$38	N/A	+\$38	N/A	6
30"	18"	\$175	+\$38	N/A	+\$38	N/A	7
30"	24"	\$225	+\$38	N/A	+\$38	N/A	9
30"	30"	\$285	+\$38	N/A	+\$38	N/A	10
36"	12"	\$145	+\$38	N/A	+\$38	N/A	6
36"	16"	\$180	+\$38	N/A	+\$38	N/A	7
36"	18"	\$205	+\$38	N/A	+\$38	N/A	8
36"	24"	\$245	+\$38	N/A	+\$38	N/A	10
36"	30"	\$295	+\$38	N/A	+\$38	N/A	12
42"	12"	\$170	+\$38	N/A	+\$38	N/A	6
42"	16"	\$210	+\$38	N/A	+\$38	N/A	8
42"	18"	\$240	+\$38	N/A	+\$38	N/A	9
42"	24"	\$320	+\$38	N/A	+\$38	N/A	11
42"	30"	\$370	+\$38	N/A	+\$38	N/A	14
48"	12"	\$190	+\$38	N/A	+\$38	N/A	7
48"	16"	\$225	+\$38	N/A	+\$38	N/A	9
48"	18"	\$265	+\$38	N/A	+\$38	N/A	10
48"	24"	\$325	+\$38	N/A	+\$38	N/A	13
48"	30"	\$380	+\$38	N/A	+\$38	N/A	16
54"	12"	\$195	+\$38	N/A	+\$38	N/A	8
54"	16"	\$250	+\$38	N/A	+\$38	N/A	10
54"	18"	\$290	+\$38	N/A	+\$38	N/A	11
54"	24"	\$335	+\$38	N/A	+\$38	N/A	14
54"	30"	\$525	+\$38	N/A	+\$38	N/A	18
60"	12"	\$230	N/A	+\$76	N/A	+\$76	9
60"	16"	\$295	N/A	+\$76	N/A	+\$76	11
60"	18"	\$325	N/A	+\$76	N/A	+\$76	13
60"	24"	\$430	N/A	+\$76	N/A	+\$76	16
60"	30"	\$530	N/A	+\$76	N/A	+\$76	20
66"	12"	\$235	N/A	+\$76	N/A	+\$76	10
66"	16"	\$300	N/A	+\$76	N/A	+\$76	12
66"	18"	\$330	N/A	+\$76	N/A	+\$76	14
66"	24"	\$435	N/A	+\$76	N/A	+\$76	18
66"	30"	\$540	N/A	+\$76	N/A	+\$76	22
72"	12"	\$255	N/A	+\$76	N/A	+\$76	11
72"	16"	\$305	N/A	+\$76	N/A	+\$76	13
72"	18"	\$375	N/A	+\$76	N/A	+\$76	15
72"	24"	\$445	N/A	+\$76	N/A	+\$76	19
72"	30"	\$545	N/A	+\$76	N/A	+\$76	23



TOWER MOUNT

For installation on top of cubicle with flat surface



SQUARE MOUNT

For installation on top of cubicle with flat or curved surface



CLAMP MOUNT

NOTE: Frosted Acrylic .2" thick with smooth edges

All pricing in USD

Frosted Acrylic is fabricated from 100% virgin material

Acrylic is frosted on both sides of panel

Clamp Mount

24"-54" use CPM2 add \$80 to list price

60"-72" use CPM4 add \$160 to list price



PANEL STACKERS
Clear Acrylic
(CLR)

MOUNTING OPTIONS

Width	Height	STK-CLR	MOUNTING OPTIONS				Weight (lbs)
		Price	Tower Mount 2 Clamps (TW2)	Tower Mount 4 Clamps (TW4)	Square Mount 2 Clamps (TW2)	Square Mount 4 Clamps (TW4)	
24"	12"	\$110	+\$38	N/A	+\$38	N/A	4
24"	16"	\$130	+\$38	N/A	+\$38	N/A	5
24"	18"	\$155	+\$38	N/A	+\$38	N/A	6
24"	24"	\$180	+\$38	N/A	+\$38	N/A	7
24"	30"	\$330	+\$38	N/A	+\$38	N/A	9
30"	12"	\$130	+\$38	N/A	+\$38	N/A	5
30"	16"	\$160	+\$38	N/A	+\$38	N/A	6
30"	18"	\$175	+\$38	N/A	+\$38	N/A	7
30"	24"	\$235	+\$38	N/A	+\$38	N/A	9
30"	30"	\$400	+\$38	N/A	+\$38	N/A	10
36"	12"	\$145	+\$38	N/A	+\$38	N/A	6
36"	16"	\$180	+\$38	N/A	+\$38	N/A	7
36"	18"	\$225	+\$38	N/A	+\$38	N/A	8
36"	24"	\$320	+\$38	N/A	+\$38	N/A	10
36"	30"	\$405	+\$38	N/A	+\$38	N/A	12
42"	12"	\$170	+\$38	N/A	+\$38	N/A	6
42"	16"	\$210	+\$38	N/A	+\$38	N/A	8
42"	18"	\$240	+\$38	N/A	+\$38	N/A	9
42"	24"	\$325	+\$38	N/A	+\$38	N/A	11
42"	30"	\$415	+\$38	N/A	+\$38	N/A	14
48"	12"	\$260	+\$38	N/A	+\$38	N/A	7
48"	16"	\$335	+\$38	N/A	+\$38	N/A	9
48"	18"	\$465	+\$38	N/A	+\$38	N/A	10
48"	24"	\$475	+\$38	N/A	+\$38	N/A	13
48"	30"	\$875	+\$38	N/A	+\$38	N/A	16
54"	12"	\$265	+\$38	N/A	+\$38	N/A	8
54"	16"	\$340	+\$38	N/A	+\$38	N/A	10
54"	18"	\$470	+\$38	N/A	+\$38	N/A	11
54"	24"	\$485	+\$38	N/A	+\$38	N/A	14
54"	30"	\$885	+\$38	N/A	+\$38	N/A	18
60"	12"	\$270	N/A	+\$76	N/A	+\$76	9
60"	16"	\$345	N/A	+\$76	N/A	+\$76	11
60"	18"	\$475	N/A	+\$76	N/A	+\$76	13
60"	24"	\$490	N/A	+\$76	N/A	+\$76	16
60"	30"	\$890	N/A	+\$76	N/A	+\$76	20
66"	12"	\$275	N/A	+\$76	N/A	+\$76	10
66"	16"	\$350	N/A	+\$76	N/A	+\$76	12
66"	18"	\$485	N/A	+\$76	N/A	+\$76	14
66"	24"	\$495	N/A	+\$76	N/A	+\$76	18
66"	30"	\$900	N/A	+\$76	N/A	+\$76	22
72"	12"	\$280	N/A	+\$76	N/A	+\$76	11
72"	16"	\$350	N/A	+\$76	N/A	+\$76	13
72"	18"	\$485	N/A	+\$76	N/A	+\$76	15
72"	24"	\$500	N/A	+\$76	N/A	+\$76	19
72"	30"	\$905	N/A	+\$76	N/A	+\$76	23



TOWER MOUNT

For installation on top of cubicle with flat surface



SQUARE MOUNT

For installation on top of cubicle with flat or curved surface



CLAMP MOUNT

NOTE:
All pricing in USD

Clamp Mount
24"-54" use CPM2 add \$80 to list price
60" -72" use CPM4 add \$160 to list price

PANEL STACKERS - ECHOSCAPE™ 3/4" (18MM)



PANEL STACKERS
EchoScape™
3/4" (18mm)(PE18)



Shown with Tower Mount (TW2)



Shown with Tower Mount (TW4)

See pages 7-8 for Banner Design Cutout Options

MOUNTING OPTIONS

		STK-PE18		Tower Mount 2 Clamps (TW2)	Tower Mount 4 Clamps (TW4)	Weight (lbs)
Width	Height	Price	Banner Design Cutout (optional)			
24"	12"	\$115	+ \$30	+\$38	N/A	3
24"	16"	\$150	+ \$30	+\$38	N/A	3
24"	18"	\$155	+ \$30	+\$38	N/A	4
24"	24"	\$190	+ \$30	+\$38	N/A	4
24"	30"	\$235	+ \$30	+\$38	N/A	5
30"	12"	\$140	+ \$40	+\$38	N/A	3
30"	16"	\$160	+ \$40	+\$38	N/A	4
30"	18"	\$175	+ \$40	+\$38	N/A	4
30"	24"	\$200	+ \$40	+\$38	N/A	5
30"	30"	\$245	+ \$40	+\$38	N/A	6
36"	12"	\$160	+ \$40	+\$38	N/A	4
36"	16"	\$195	+ \$40	+\$38	N/A	4
36"	18"	\$210	+ \$40	+\$38	N/A	5
36"	24"	\$240	+ \$40	+\$38	N/A	6
36"	30"	\$300	+ \$40	+\$38	N/A	7
42"	12"	\$180	+ \$50	+\$38	N/A	4
42"	16"	\$205	+ \$50	+\$38	N/A	5
42"	18"	\$225	+ \$50	+\$38	N/A	5
42"	24"	\$300	+ \$50	+\$38	N/A	7
42"	30"	\$335	+ \$50	+\$38	N/A	8
48"	12"	\$200	+ \$50	+\$38	N/A	4
48"	16"	\$240	+ \$50	+\$38	N/A	5
48"	18"	\$265	+ \$50	+\$38	N/A	6
48"	24"	\$310	+ \$50	+\$38	N/A	7
48"	30"	\$415	+ \$50	+\$38	N/A	9
54"	12"	\$215	+ \$60	+\$38	N/A	5
54"	16"	\$255	+ \$60	+\$38	N/A	6
54"	18"	\$280	+ \$60	+\$38	N/A	7
54"	24"	\$325	+ \$60	+\$38	N/A	8
54"	30"	\$425	+ \$60	+\$38	N/A	10
60"	12"	\$225	+ \$60	N/A	+\$76	6
60"	16"	\$265	+ \$60	N/A	+\$76	7
60"	18"	\$290	+ \$60	N/A	+\$76	8
60"	24"	\$340	+ \$60	N/A	+\$76	9
60"	30"	\$435	+ \$60	N/A	+\$76	11
66"	12"	\$280	+ \$70	N/A	+\$76	6
66"	16"	\$370	+ \$70	N/A	+\$76	7
66"	18"	\$375	+ \$70	N/A	+\$76	8
66"	24"	\$490	+ \$70	N/A	+\$76	10
66"	30"	\$530	+ \$70	N/A	+\$76	12
72"	12"	\$290	+ \$70	N/A	+\$76	6
72"	16"	\$380	+ \$70	N/A	+\$76	8
72"	18"	\$390	+ \$70	N/A	+\$76	9
72"	24"	\$505	+ \$70	N/A	+\$76	11
72"	30"	\$540	+ \$70	N/A	+\$76	13



TOWER MOUNT

For installation on top of cubicle with flat surface

NOTE:

All pricing in USD

Sound Absorbent -
EchoScape™ 3/4" (18mm) is rated at .9 NRC

Eco-Friendly -
EchoScape™ is made from 60% post-consumer reclaimed plastic water bottles, is VOC-free, and 100% recyclable

EchoScape 3/4" thick Stackers can only be installed on a flat cubicle surface using the Tower Mount

PANEL STACKERS - ECHOSCAPE™ 3/4" (18MM) - INVISIBLE MOUNT



PANEL STACKERS - INVISIBLE MOUNT

EchoScape™ 3/4" (18mm)
(IPE18)

See pages 7-8 for Banner
Design Cutout Options

Invisible Mount not compatible with 12" high
Panel Stackers with Banner Design Cutout

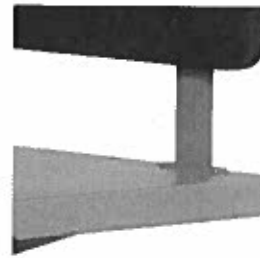

Shown with EchoScape™
Invisible Mount
(IPE18)

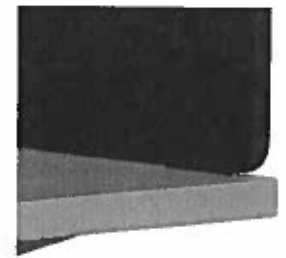

Shown with EchoScape™
Invisible Mount
(IPE18)

MOUNTING
OPTION

STK-IPE18				Invisible Mount	Weight (lbs)
Width	Height	Price	Banner Design Cutout (optional)		
24"	12"	\$115	N/A	+\$38	3
24"	16"	\$150	+ \$30	+\$38	3
24"	18"	\$155	+ \$30	+\$38	4
24"	24"	\$190	+ \$30	+\$38	4
24"	30"	\$235	+ \$30	+\$38	5
30"	12"	\$140	N/A	+\$38	3
30"	16"	\$160	+ \$40	+\$38	4
30"	18"	\$175	+ \$40	+\$38	4
30"	24"	\$200	+ \$40	+\$38	5
30"	30"	\$250	+ \$40	+\$38	6
36"	12"	\$160	N/A	+\$38	4
36"	16"	\$195	+ \$40	+\$38	4
36"	18"	\$210	+ \$40	+\$38	5
36"	24"	\$240	+ \$40	+\$38	6
36"	30"	\$300	+ \$40	+\$38	7
42"	12"	\$180	N/A	+\$38	4
42"	16"	\$205	+ \$50	+\$38	5
42"	18"	\$225	+ \$50	+\$38	5
42"	24"	\$300	+ \$50	+\$38	7
42"	30"	\$335	+ \$50	+\$38	8
48"	12"	\$200	N/A	+\$38	4
48"	16"	\$240	+ \$50	+\$38	5
48"	18"	\$265	+ \$50	+\$38	6
48"	24"	\$310	+ \$50	+\$38	7
48"	30"	\$415	+ \$50	+\$38	9
54"	12"	\$215	N/A	+\$38	5
54"	16"	\$255	+ \$60	+\$38	6
54"	18"	\$280	+ \$60	+\$38	7
54"	24"	\$325	+ \$60	+\$38	8
54"	30"	\$425	+ \$60	+\$38	10
60"	12"	\$225	N/A	+\$38	6
60"	16"	\$265	+ \$60	+\$38	7
60"	18"	\$290	+ \$60	+\$38	8
60"	24"	\$340	+ \$60	+\$38	9
60"	30"	\$435	+ \$60	+\$38	11
66"	12"	\$280	N/A	+\$38	6
66"	16"	\$370	+ \$70	+\$38	7
66"	18"	\$375	+ \$70	+\$38	8
66"	24"	\$490	+ \$70	+\$38	10
66"	30"	\$535	+ \$70	+\$38	12
72"	12"	\$290	N/A	+\$38	6
72"	16"	\$380	+ \$70	+\$38	8
72"	18"	\$390	+ \$70	+\$38	9
72"	24"	\$505	+ \$70	+\$38	11
72"	30"	\$540	+ \$70	+\$38	13

Invisible Mounting for installation on
top of cubicle with a flat surface

NOTE:

All pricing in USD

Sound Absorbent - EchoScape™ 3/4"
(18mm) is rated at .9 NRC

Eco-Friendly -

EchoScape™ is made from 60%
post-consumer reclaimed plastic water
bottles, is VOC-free, and 100% recyclable

PANEL STACKERS - ECHOSCAPE™ 3/8" (9MM)



ALLSTATE
OFFICE INTERIORS

PANEL STACKERS
EchoScape™ 3/8" (9mm)
(PE9)



Shown with Square Mount (SQ2)



Shown with Square Mount (SQ4)

See pages 7-8 for Banner Design Cutout Options

MOUNTING OPTIONS

STK-PE9			Tower Mount 2 Clamps (TW2)	Tower Mount 4 Clamps (TW4)	Square Mount 2 Clamps (TW2)	Square Mount 4 Clamps (TW4)	Weight (lbs)	
Width	Height	Price	Banner Design Cutout (optional)					
24"	12"	\$100	+\$30	+\$38	N/A	+\$38	N/A	2
24"	16"	\$110	+\$30	+\$38	N/A	+\$38	N/A	3
24"	18"	\$120	+\$30	+\$38	N/A	+\$38	N/A	3
24"	24"	\$140	+\$30	+\$38	N/A	+\$38	N/A	3
24"	30"	\$175	+\$30	+\$38	N/A	+\$38	N/A	4
30"	12"	\$110	+\$40	+\$38	N/A	+\$38	N/A	3
30"	16"	\$125	+\$40	+\$38	N/A	+\$38	N/A	3
30"	18"	\$140	+\$40	+\$38	N/A	+\$38	N/A	3
30"	24"	\$150	+\$40	+\$38	N/A	+\$38	N/A	4
30"	30"	\$185	+\$40	+\$38	N/A	+\$38	N/A	5
36"	12"	\$125	+\$40	+\$38	N/A	+\$38	N/A	3
36"	16"	\$140	+\$40	+\$38	N/A	+\$38	N/A	3
36"	18"	\$160	+\$40	+\$38	N/A	+\$38	N/A	4
36"	24"	\$185	+\$40	+\$38	N/A	+\$38	N/A	4
36"	30"	\$195	+\$40	+\$38	N/A	+\$38	N/A	5
42"	12"	\$135	+\$50	+\$38	N/A	+\$38	N/A	3
42"	16"	\$155	+\$50	+\$38	N/A	+\$38	N/A	4
42"	18"	\$170	+\$50	+\$38	N/A	+\$38	N/A	4
42"	24"	\$195	+\$50	+\$38	N/A	+\$38	N/A	5
42"	30"	\$200	+\$50	+\$38	N/A	+\$38	N/A	6
48"	12"	\$165	+\$50	+\$38	N/A	+\$38	N/A	3
48"	16"	\$195	+\$50	+\$38	N/A	+\$38	N/A	4
48"	18"	\$235	+\$50	+\$38	N/A	+\$38	N/A	4
48"	24"	\$250	+\$50	+\$38	N/A	+\$38	N/A	5
48"	30"	\$365	+\$50	+\$38	N/A	+\$38	N/A	6
54"	12"	\$175	+\$60	+\$38	N/A	+\$38	N/A	4
54"	16"	\$205	+\$60	+\$38	N/A	+\$38	N/A	4
54"	18"	\$245	+\$60	+\$38	N/A	+\$38	N/A	5
54"	24"	\$260	+\$60	+\$38	N/A	+\$38	N/A	6
54"	30"	\$375	+\$60	+\$38	N/A	+\$38	N/A	7
60"	12"	\$185	+\$60	N/A	+\$76	N/A	+\$76	4
60"	16"	\$215	+\$60	N/A	+\$76	N/A	+\$76	5
60"	18"	\$255	+\$60	N/A	+\$76	N/A	+\$76	6
60"	24"	\$270	+\$60	N/A	+\$76	N/A	+\$76	7
60"	30"	\$380	+\$60	N/A	+\$76	N/A	+\$76	8
66"	12"	\$190	+\$70	N/A	+\$76	N/A	+\$76	5
66"	16"	\$220	+\$70	N/A	+\$76	N/A	+\$76	6
66"	18"	\$265	+\$70	N/A	+\$76	N/A	+\$76	6
66"	24"	\$285	+\$70	N/A	+\$76	N/A	+\$76	7
66"	30"	\$390	+\$70	N/A	+\$76	N/A	+\$76	9
72"	12"	\$205	+\$70	N/A	+\$76	N/A	+\$76	5
72"	16"	\$240	+\$70	N/A	+\$76	N/A	+\$76	6
72"	18"	\$285	+\$70	N/A	+\$76	N/A	+\$76	6
72"	24"	\$305	+\$70	N/A	+\$76	N/A	+\$76	8
72"	30"	\$430	+\$70	N/A	+\$76	N/A	+\$76	9



TOWER MOUNT

For installation on top of cubicle with flat surface



SQUARE MOUNT

For installation on top of cubicle with flat or curved surface

NOTE: Sound Absorbent - EchoScape™ 3/8" (9mm) is rated at .85 NRC

All pricing in USD

Eco-Friendly - EchoScape™ is made from 60% post-consumer reclaimed plastic water bottles, is VOC-free, and 100% recyclable

DESIGN CUTOUTS

Available in EchoScape™ (PE18), EchoScape™ Invisible Mount (IPE18), and EchoScape™ (PE9)

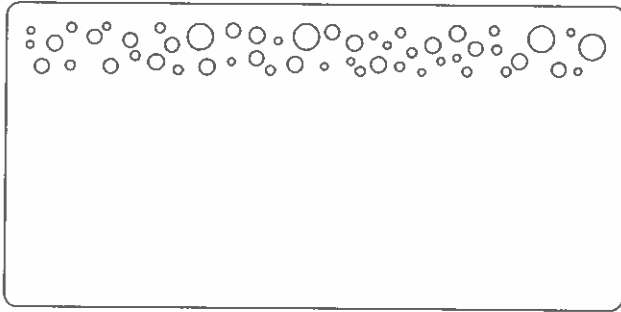

D002 - FIZZY

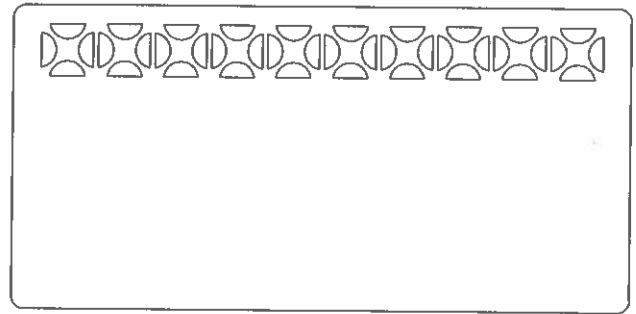

D004 - METRO

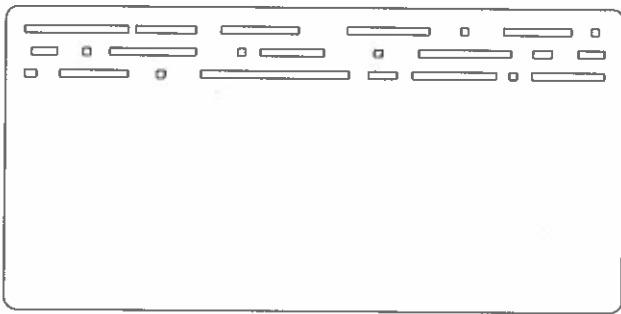

D005 - DASH

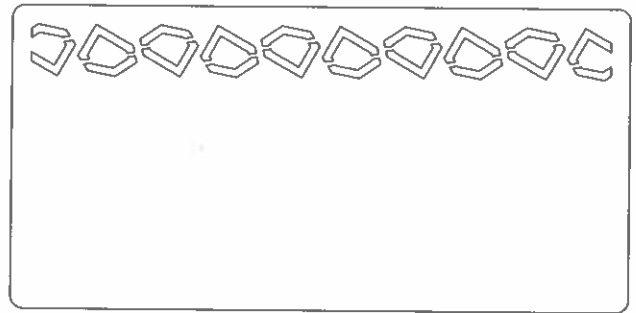

D008 - TRIBAL

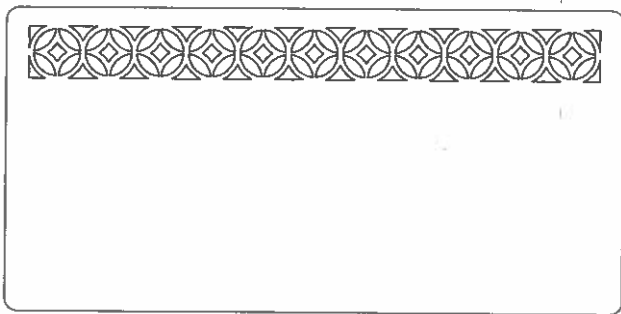

D016 - RETRO

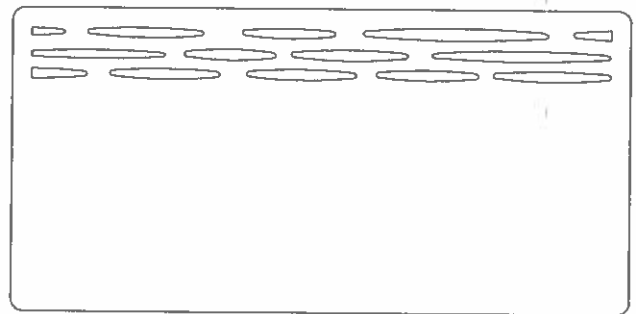

D017 - STRATA

DESIGN CUTOUTS

Available in EchoScape™ (PE18), EchoScape™ Invisible Mount (IPE18), and EchoScape™ (PE9)

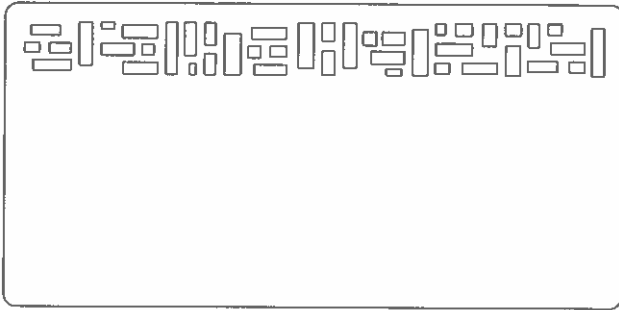

D021 - MAZE

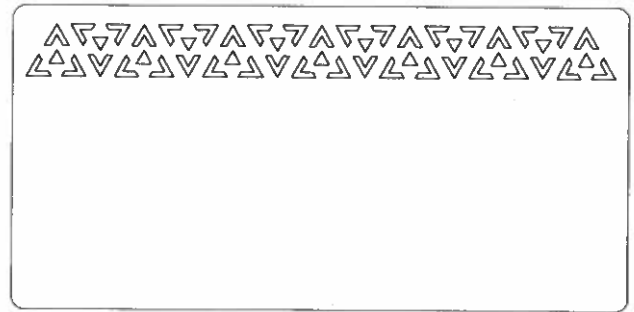

D022 - AZTEC

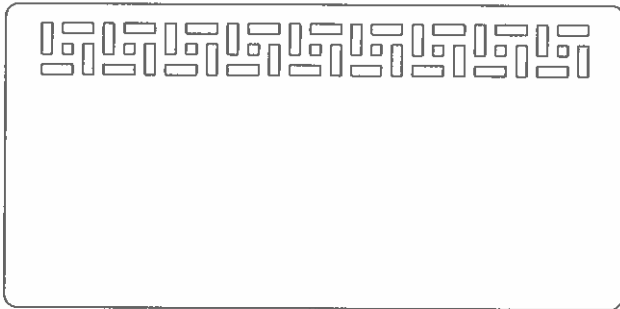

D023 - PINWHEEL

ECHOSCAPE™ 3/4" (18MM) (P1_)

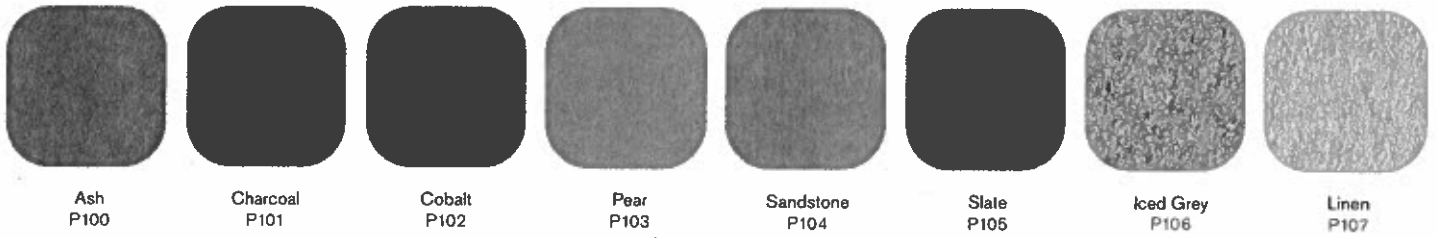

ECHOSCAPE™ 3/8" (9MM) (P1_)

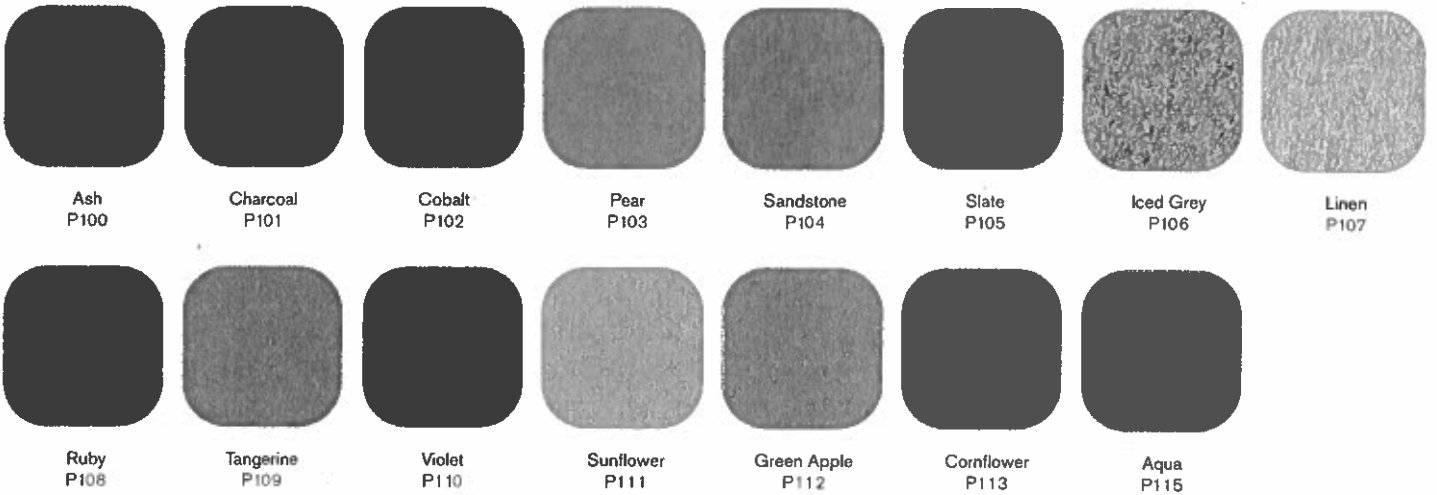

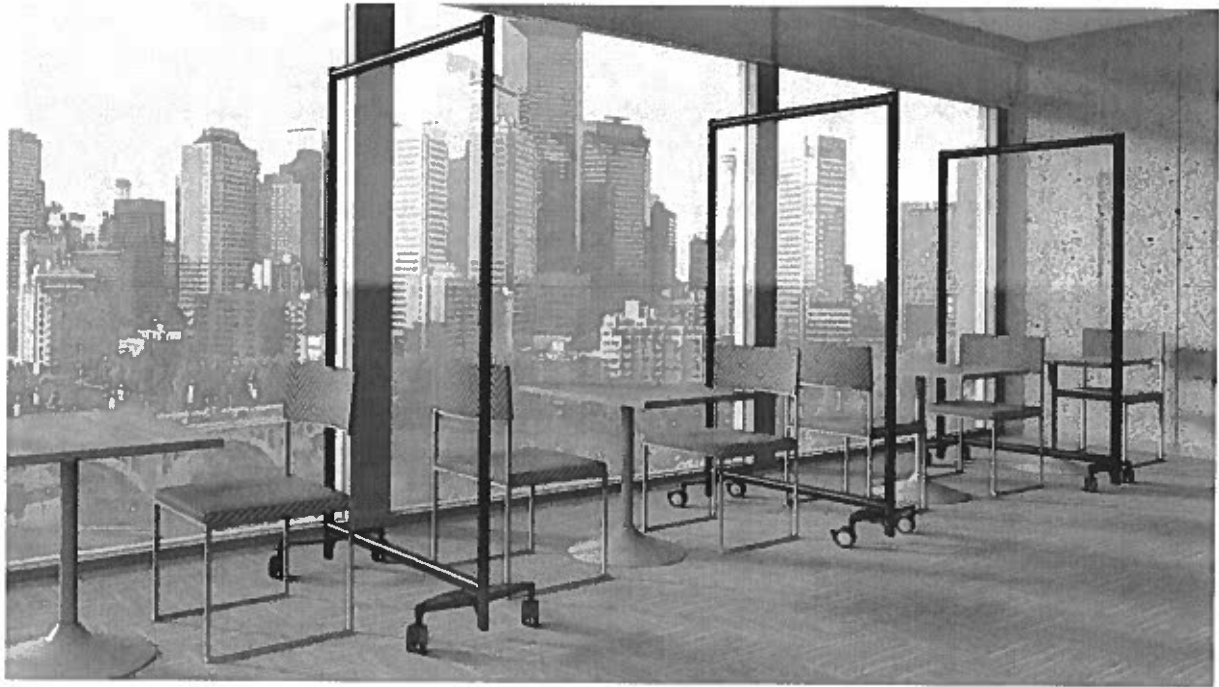

PRIVACY SCREENS

Define your space with Duplex™ and Villa™ Screens. Lightweight and easy to install, AOI modular screens are a cost-effective solution for creating custom cubicles, workstations, study carrels or private work areas. Our modular screens come in a wide range of heights, widths and core options making it easy to design a custom configuration that fits the size and look of your current space.

Villa™ Screens feature a single core material, while Duplex™ Screens are configured using two material cores for an added design touch. Both modular panels styles can be hinged together to create your custom workspace.

- Framework is constructed using lightweight aluminum extrusion
- All metal parts are anodized or powder coated for an aesthetic and durable finish
- Core materials include Frosted and Clear Acrylic, Fabric and TruBrite™ Whiteboard
- Villa™ and Duplex™ Screens can be hinged together to create 2, 3 or 4-way configurations
- Made in the USA
- Villa™ and Duplex™ screen are available in custom sizes, core materials and colors

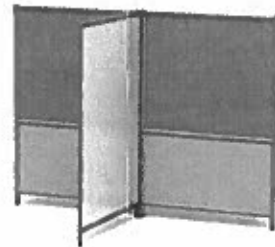

How to build your SKU:

Step 1: Choose your Model <input type="text" value="3X"/>	Step 2: Choose your Width <input type="text" value="37"/>	Step 3: Choose your Height <input type="text" value="54"/>	Step 4: Choose your Frame Color <input type="text" value="AA"/>	Step 5: Choose your Foot Option <input type="text" value="2WF"/>	Step 6: Choose your Full Core Material (2X) Upper Core Material (3X) <input type="text" value="FRO"/>	Step 8: Choose your Lower Core Material (3X) <input type="text" value="F220"/> <small>(3X only)</small>
--	--	---	--	---	---	---

MODULAR SCREENS

Model	Width	Height	Frame Color	Foot Options	Core Materials
2X Villa™ Wall	24"	42"	AA Satin Aluminum	4 4 Wheels	FRO Frosted Acrylic
3X Duplex™ Wall	30"	48"	20 Pewter	2WF 2 Wheels-1 Foot	CLR Clear Acrylic
	37"	54"	BK Black	3WL 2 Wheels-1 Leveler	WB TruBrite™ Whiteboard (Both Sides)
	42"	62"		F Freestanding (2 Feet)	A1_ Colored Frosted Acrylic
	49"	72"		FL 1 Foot- 1 Leveler	F1_ Fabric 100 Series
	61"			NF No Feet	F2_ Fabric 200 Series
	73"			L 2 Levelers	L1_ Laminates & Wood Grains 100 Series
				WBF1_ TruBrite™ (Side 1)/ Fabric 1_ (Side 2)	
				WBF2_ TruBrite™ (Side 1)/ Fabric 2_ (Side 2)	

VILLA SCREEN
(Model 2X) Full
Core Model

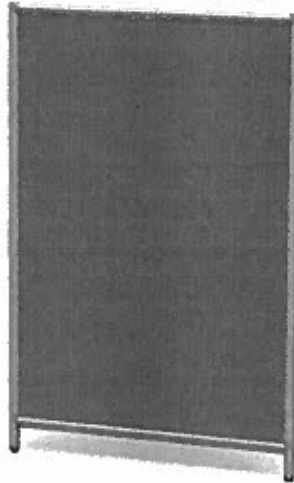

Shown with 2 Levelers (L)

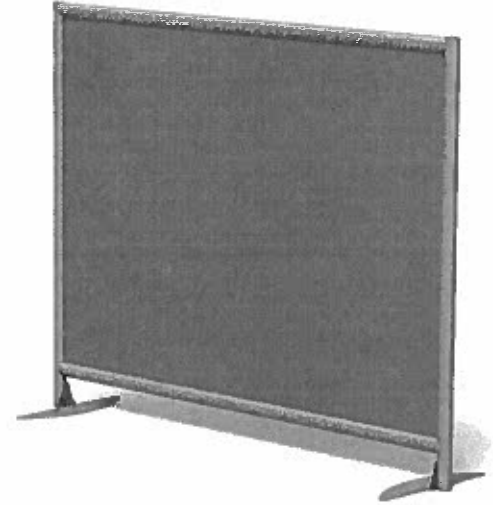

Shown as Freestanding (F)

FOOT OPTIONS

Width	Height	Weight (lbs)	FRO	CLR	WB	A1_	F1_	F2_	L1_	FOOT OPTIONS						
			Frosted Acrylic	Clear Acrylic	Whiteboard	Colored Frosted Acrylic	Fabric 100 Series	Fabric 200 Series	Laminate 100 Series	4 Wheels	2 Wheels-1 Foot	2 Wheels-1 Leveler	Free-standing	1 Foot-1 Leveler	No Feet	2 Levelers
24"	42"	11	\$490	\$490	\$490	\$600	\$515	\$595	\$635	+\$180	+\$180	+\$90	+\$180	+\$90	+\$0	+\$0
24"	48"	13	\$545	\$545	\$540	\$655	\$565	\$635	\$670	+\$180	+\$180	+\$90	+\$180	+\$90	+\$0	+\$0
24"	54"	14	\$575	\$575	\$565	\$680	\$605	\$665	\$700	+\$180	+\$180	+\$90	+\$180	+\$90	+\$0	+\$0
24"	62"	15	\$690	\$690	\$720	\$910	\$660	\$778	\$785	+\$180	+\$180	+\$90	+\$180	+\$90	+\$0	+\$0
24"	72"	18	\$735	\$735	\$760	\$955	\$790	\$953	N/A	+\$180	+\$180	+\$90	+\$180	+\$90	+\$0	+\$0
30"	42"	13	\$600	\$600	\$595	\$745	\$620	\$690	\$760	+\$180	+\$180	+\$90	+\$180	+\$90	+\$0	+\$0
30"	48"	15	\$630	\$630	\$625	\$775	\$655	\$730	\$795	+\$180	+\$180	+\$90	+\$180	+\$90	+\$0	+\$0
30"	54"	16	\$660	\$660	\$655	\$805	\$685	\$760	\$825	+\$180	+\$180	+\$90	+\$180	+\$90	+\$0	+\$0
30"	62"	18	\$945	\$945	\$1,035	\$1,385	\$785	\$948	\$975	+\$180	+\$180	+\$90	+\$180	+\$90	+\$0	+\$0
30"	72"	21	\$995	\$995	\$1,080	\$1,435	\$1,080	\$1,368	N/A	+\$180	+\$180	+\$90	+\$180	+\$90	+\$0	+\$0
37"	42"	16	\$670	\$670	\$700	\$890	\$715	\$805	\$915	+\$180	+\$180	+\$90	+\$180	+\$90	+\$0	+\$0
37"	48"	17	\$700	\$700	\$730	\$920	\$750	\$840	\$950	+\$180	+\$180	+\$90	+\$180	+\$90	+\$0	+\$0
37"	54"	19	\$735	\$735	\$760	\$950	\$790	\$880	\$985	+\$180	+\$180	+\$90	+\$180	+\$90	+\$0	+\$0
37"	62"	22	\$985	\$985	\$1,075	\$1,430	\$870	\$1,055	\$1,140	+\$180	+\$180	+\$90	+\$180	+\$90	+\$0	+\$0
37"	72"	25	\$1,040	\$1,040	\$1,125	\$1,485	\$1,145	\$1,443	N/A	+\$180	+\$180	+\$90	+\$180	+\$90	+\$0	+\$0
42"	42"	17	\$695	\$695	\$725	\$915	\$750	\$865	\$945	+\$180	+\$180	+\$90	+\$180	+\$90	+\$0	+\$0
42"	48"	19	\$790	\$790	\$795	\$1,005	\$805	\$905	\$980	+\$180	+\$180	+\$90	+\$180	+\$90	+\$0	+\$0
42"	54"	21	\$820	\$820	\$825	\$1,040	\$840	\$945	\$1,015	+\$180	+\$180	+\$90	+\$180	+\$90	+\$0	+\$0
42"	62"	23	\$1,020	\$1,020	\$1,105	\$1,460	\$930	\$1,130	\$1,175	+\$180	+\$180	+\$90	+\$180	+\$90	+\$0	+\$0
42"	72"	27	\$1,075	\$1,075	\$1,160	\$1,515	\$1,185	\$1,488	N/A	+\$180	+\$180	+\$90	+\$180	+\$90	+\$0	+\$0
49"	42"	19	\$735	\$735	\$760	\$950	\$790	\$960	\$1,085	+\$180	+\$180	+\$90	+\$180	+\$90	+\$0	+\$0
49"	48"	21	\$825	\$825	\$830	\$1,045	\$880	\$1,020	\$1,145	+\$180	+\$180	+\$90	+\$180	+\$90	+\$0	+\$0
49"	54"	24	\$865	\$865	\$865	\$1,085	\$945	\$1,065	\$1,185	+\$180	+\$180	+\$90	+\$180	+\$90	+\$0	+\$0
49"	62"	27	\$1,065	\$1,065	\$1,150	\$1,505	\$1,015	\$1,238	\$1,335	+\$180	+\$180	+\$90	+\$180	+\$90	+\$0	+\$0
49"	72"	31	\$1,125	\$1,125	\$1,205	\$1,565	\$1,245	\$1,555	N/A	+\$180	+\$180	+\$90	+\$180	+\$90	+\$0	+\$0
61"	42"	23	\$1,015	\$1,015	\$1,100	\$1,455	\$1,005	\$1,150	\$1,285	+\$180	+\$180	+\$90	+\$180	+\$90	+\$0	+\$0
61"	48"	25	\$1,050	\$1,050	\$1,135	\$1,495	\$1,050	\$1,200	\$1,325	+\$180	+\$180	+\$90	+\$180	+\$90	+\$0	+\$0
61"	54"	28	\$1,090	\$1,090	\$1,175	\$1,530	\$1,100	\$1,245	\$1,365	+\$180	+\$180	+\$90	+\$180	+\$90	+\$0	+\$0
73"	42"	26	\$1,080	\$1,080	\$1,165	\$1,520	\$1,210	\$1,385	\$1,580	+\$180	+\$180	+\$90	+\$180	+\$90	+\$0	+\$0
73"	48"	30	\$1,120	\$1,120	\$1,200	\$1,560	\$1,260	\$1,435	\$1,625	+\$180	+\$180	+\$90	+\$180	+\$90	+\$0	+\$0
73"	54"	32	\$1,160	\$1,160	\$1,240	\$1,600	\$1,315	\$1,490	\$1,670	+\$180	+\$180	+\$90	+\$180	+\$90	+\$0	+\$0

NOTE:

All pricing in USD

Not available with TruBrite™ Whiteboard on one side and Fabric on the other side

DUPLEX™ SCREEN
(Model 3X)
Segmented Two-Core
Model

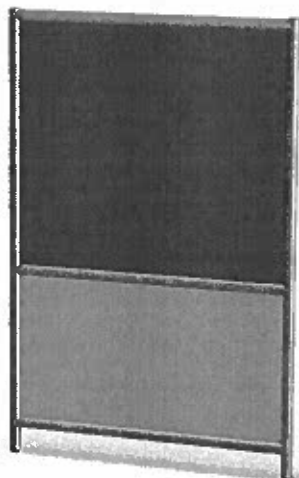

Shown with 2 Levelers (L)

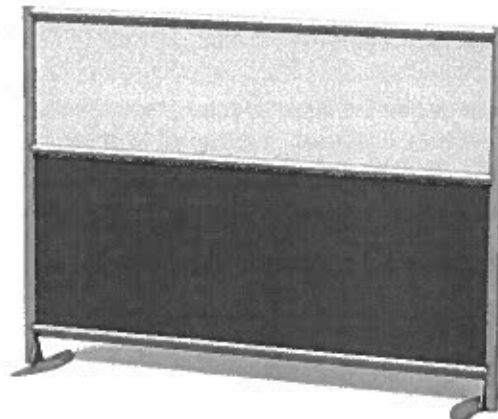

Shown as Freestanding (F)

24" Width				T1 TOP CORE MATERIALS								
Width	Height	Weight (lbs)	Frame Base Price	FRO	CLR	WB	A1_	F1_	F2_	WBF1_	WBF2_	L1_
				Frosted Acrylic	Clear Acrylic	White-board	Colored Frosted Acrylic	Fabric 100 Series	Fabric 200 Series	WB/Fabric 100 Series	WB/Fabric 200 Series	Laminate 100 Series
24"	42"	12	\$400	+\$60	+\$60	+\$40	+\$80	+\$75	+\$90	+\$65	+\$75	+\$90
24"	48"	14	\$425	+\$85	+\$85	+\$65	+\$130	+\$95	+\$140	+\$90	+\$115	+\$115
24"	54"	15	\$450	+\$105	+\$105	+\$80	+\$155	+\$120	+\$150	+\$120	+\$135	+\$165
24"	62"	16	\$485	+\$130	+\$130	+\$105	+\$200	+\$155	+\$245	+\$155	+\$205	+\$200
24"	72"	19	\$525	+\$180	+\$180	+\$160	+\$290	+\$195	+\$260	+\$215	+\$255	+\$300
B1 - Lower core option for all 24" wide Duplex Walls (Height is 31" for all lower cores)				B1 LOWER CORE MATERIALS								
				FRO	CLR	WB	A1_	F1_	F2_	WBF1_	WBF2_	L1_
				Frosted Acrylic	Clear Acrylic	White-board	Colored Frosted	Fabric 100	Fabric 200	WB/Fabric 100	WB/Fabric 200	Laminate 100
				+\$130	+\$130	+\$90	+\$160	+\$125	+\$150	+\$125	+\$140	+\$165
FOOT OPTIONS												
				4 Wheels	2 Wheels-1 Foot	2 Wheels-1 Leveler	Free-standing	1 Foot-1 Leveler	No Feet	2 Levelers		
				+\$180	+\$180	+\$90	+\$180	+\$90	+\$0	+\$0		

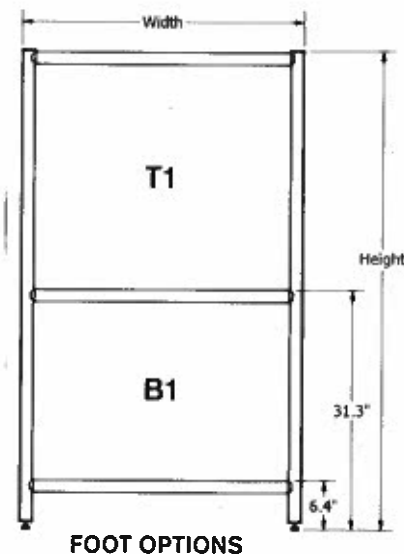

NOTE:
All pricing in USD

30" Width				T1 TOP CORE MATERIALS									
Width	Height	Weight (lbs)	Frame Base Price	FRO	CLR	WB	A1_	F1_	F2_	WBF1_	WBF2_	L1_	
				Frosted Acrylic	Clear Acrylic	White-board	Colored Frosted Acrylic	Fabric 100 Series	Fabric 200 Series	WB/Fabric 100 Series	WB/Fabric 200 Series	Laminate 100 Series	
30"	42"	14	\$440	+\$70	+\$70	+\$45	+\$95	+\$85	+\$105	+\$80	+\$90	+\$110	
30"	48"	16	\$465	+\$105	+\$105	+\$80	+\$155	+\$110	+\$185	+\$110	+\$140	+\$150	
30"	54"	17	\$490	+\$130	+\$130	+\$105	+\$200	+\$145	+\$180	+\$155	+\$170	+\$210	
30"	62"	19	\$525	+\$225	+\$225	+\$210	+\$370	+\$245	+\$315	+\$275	+\$315	+\$275	
30"	72"	22	\$570	+\$230	+\$230	+\$210	+\$375	+\$255	+\$325	+\$285	+\$320	+\$395	

B1 - Lower core option for all 30" wide Duplex Walls (Height is 31" for all lower cores)	B1 LOWER CORE MATERIALS									
	FRO	CLR	WB	A1_	F1_	F2_	WBF1_	WBF2_	L1_	
	Frosted Acrylic	Clear Acrylic	White-board	Colored Frosted	Fabric 100	Fabric 200	WB/Fabric 100	WB/Fabric 200	Laminate 100	
	+\$220	+\$220	+\$115	+\$200	+\$150	+\$185	+\$155	+\$175	+\$215	

FOOT OPTIONS						
4 Wheels	2 Wheels-1 Foot	2 Wheels-1 Leveler	Free-standing	1 Foot-1 Leveler	No Feet	2 Levelers
+\$180	+\$180	+\$90	+\$180	+\$90	+\$0	+\$0

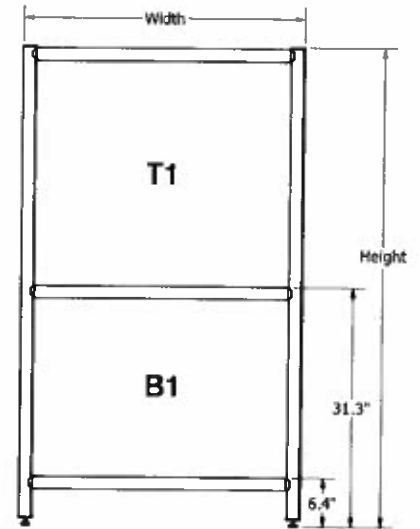

37" Width				T1 TOP CORE MATERIALS									
Width	Height	Weight (lbs)	Frame Base Price	FRO	CLR	WB	A1_	F1_	F2_	WBF1_	WBF2_	L1_	
				Frosted Acrylic	Clear Acrylic	White-board	Colored Frosted Acrylic	Fabric 100 Series	Fabric 200 Series	WB/Fabric 100 Series	WB/Fabric 200 Series	Laminate 100 Series	
37"	42"	17	\$485	+\$85	+\$85	+\$60	+\$125	+\$100	+\$125	+\$95	+\$110	+\$145	
37"	48"	19	\$510	+\$145	+\$145	+\$130	+\$235	+\$130	+\$200	+\$135	+\$175	+\$190	
37"	54"	20	\$540	+\$150	+\$150	+\$130	+\$235	+\$175	+\$220	+\$180	+\$205	+\$275	
37"	62"	23	\$580	+\$230	+\$230	+\$210	+\$375	+\$275	+\$380	+\$290	+\$345	+\$345	
37"	72"	26	\$625	+\$265	+\$265	+\$270	+\$485	+\$315	+\$405	+\$360	+\$405	+\$515	

B1 - Lower core option for all 37" wide Duplex Walls (Height is 31" for all lower cores)	B1 LOWER CORE MATERIALS									
	FRO	CLR	WB	A1_	F1_	F2_	WBF1_	WBF2_	L1_	
	Frosted Acrylic	Clear Acrylic	White-board	Colored Frosted	Fabric 100	Fabric 200	WB/Fabric 100	WB/Fabric 200	Laminate 100	
	+\$225	+\$225	+\$140	+\$240	+\$180	+\$225	+\$185	+\$210	+\$275	

FOOT OPTIONS						
4 Wheels	2 Wheels-1 Foot	2 Wheels-1 Leveler	Free-standing	1 Foot-1 Leveler	No Feet	2 Levelers
+\$180	+\$180	+\$90	+\$180	+\$90	+\$0	+\$0

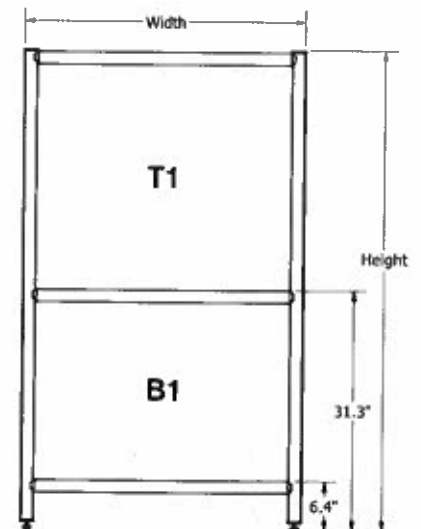

NOTE:
All pricing in USD

42" Width				T1 TOP CORE MATERIALS									
				FRO	CLR	WB	A1_	F1_	F2_	WBF1_	WBF2_	L1_	
Width	Height	Weight (lbs)	Frame Base Price	Frosted Acrylic	Clear Acrylic	White-board	Colored Frosted Acrylic	Fabric 100 Series	Fabric 200 Series	WB/Fabric 100 Series	WB/Fabric 200 Series	Laminate 100 Series	
42"	42"	19	\$510	+\$100	+\$100	+\$75	+\$145	+\$110	+\$135	+\$110	+\$125	+\$150	
42"	48"	20	\$545	+\$150	+\$150	+\$130	+\$235	+\$140	+\$220	+\$140	+\$185	+\$195	
42"	54"	23	\$570	+\$180	+\$180	+\$160	+\$290	+\$190	+\$240	+\$215	+\$245	+\$280	
42"	62"	25	\$610	+\$230	+\$230	+\$210	+\$375	+\$280	+\$420	+\$295	+\$365	+\$350	
42"	72"	29	\$660	+\$325	+\$325	+\$310	+\$545	+\$340	+\$445	+\$405	+\$460	+\$520	
B1 - Lower core option for all 42" wide Duplex Walls (Height is 31" for all lower cores)				B1 LOWER CORE MATERIALS									
				FRO	CLR	WB	A1_	F1_	F2_	WBF1_	WBF2_	L1_	
				Frosted Acrylic	Clear Acrylic	White-board	Colored Frosted	Fabric 100	Fabric 200	WB/Fabric 100	WB/Fabric 200	Laminate 100	
				+\$230	+\$230	+\$175	+\$290	+\$195	+\$245	+\$215	+\$245	+\$280	
				FOOT OPTIONS									
				4 Wheels	2 Wheels-1 Foot	2 Wheels-1 Leveler	Free-standing	1 Foot-1 Leveler	No Feet	2 Levelers			
				+\$180	+\$180	+\$90	+\$180	+\$90	+\$0	+\$0			

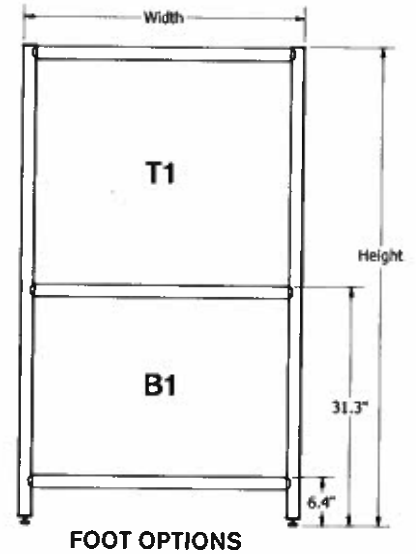

49" Width				T1 TOP CORE MATERIALS									
				FRO	CLR	WB	A1_	F1_	F2_	WBF1_	WBF2_	L1_	
Width	Height	Weight (lbs)	Frame Base Price	Frosted Acrylic	Clear Acrylic	White-board	Colored Frosted Acrylic	Fabric 100 Series	Fabric 200 Series	WB/Fabric 100 Series	WB/Fabric 200 Series	Laminate 100 Series	
49"	42"	21	\$555	+\$105	+\$105	+\$75	+\$150	+\$125	+\$155	+\$115	+\$135	+\$175	
49"	48"	23	\$590	+\$155	+\$155	+\$130	+\$240	+\$160	+\$255	+\$160	+\$210	+\$235	
49"	54"	26	\$620	+\$185	+\$185	+\$160	+\$290	+\$220	+\$280	+\$230	+\$260	+\$330	
49"	62"	29	\$665	+\$235	+\$235	+\$210	+\$380	+\$290	+\$475	+\$295	+\$395	+\$400	
49"	72"	33	\$715	+\$330	+\$330	+\$315	+\$550	+\$360	+\$505	+\$415	+\$490	+\$625	
B1 - Lower core option for all 49" wide Duplex Walls (Height is 31" for all lower cores)				B1 LOWER CORE MATERIALS									
				FRO	CLR	WB	A1_	F1_	F2_	WBF1_	WBF2_	L1_	
				Frosted Acrylic	Clear Acrylic	White-board	Colored Frosted	Fabric 100	Fabric 200	WB/Fabric 100	WB/Fabric 200	Laminate 100	
				+\$230	+\$230	+\$175	+\$295	+\$220	+\$280	+\$230	+\$260	+\$330	
				FOOT OPTIONS									
				4 Wheels	2 Wheels-1 Foot	2 Wheels-1 Leveler	Free-standing	1 Foot-1 Leveler	No Feet	2 Levelers			
				+\$180	+\$180	+\$90	+\$180	+\$90	+\$0	+\$0			

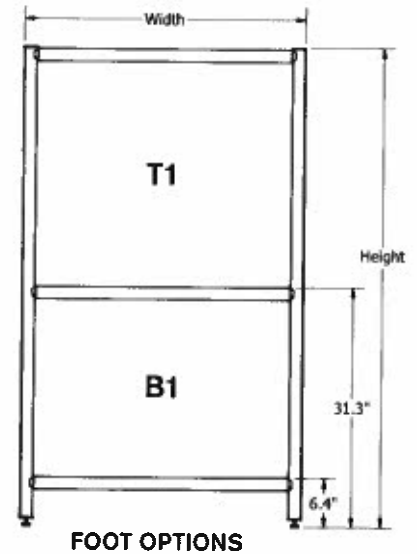

NOTE:
All pricing in USD

61" Width				T1 TOP CORE MATERIALS								
				FRO	CLR	WB	A1_	F1_	F2_	WBF1_	WBF2_	L1_
Width	Height	Weight (lbs)	Frame Base Price	Frosted Acrylic	Clear Acrylic	White-board	Colored Frosted Acrylic	Fabric 100 Series	Fabric 200 Series	WB/Fabric 100 Series	WB/Fabric 200 Series	Laminate 100 Series
61"	42"	25	\$635	+\$155	+\$155	+\$140	+\$265	+\$150	+\$185	+\$185	+\$205	+\$215
61"	48"	28	\$670	+\$265	+\$265	+\$270	+\$485	+\$195	+\$310	+\$240	+\$300	+\$285
61"	54"	30	\$705	+\$270	+\$270	+\$270	+\$485	+\$265	+\$340	+\$345	+\$380	+\$405
61"	62"	34	\$750	+\$485	+\$485	+\$535	+\$930	+\$470	+\$615	+\$645	+\$720	+\$525
61"	72"	38	\$810	+\$490	+\$490	+\$535	+\$935	+\$490	+\$635	+\$655	+\$735	+\$765

B1 - Lower core option for all 61" wide Duplex Walls (Height is 31" for all lower cores)	B1 LOWER CORE MATERIALS								
	FRO	CLR	WB	A1_	F1_	F2_	WBF1_	WBF2_	L1_
	Frosted Acrylic	Clear Acrylic	White-board	Colored Frosted	Fabric 100	Fabric 200	WB/Fabric 100	WB/Fabric 200	Laminate 100
	+\$485	+\$485	+\$295	+\$490	+\$270	+\$345	+\$345	+\$385	+\$405

FOOT OPTIONS						
4 Wheels	2 Wheels-1 Foot	2 Wheels-1 Leveler	Free-standing	1 Foot-1 Leveler	No Feet	2 Levelers
+\$180	+\$180	+\$90	+\$180	+\$90	+\$0	+\$0

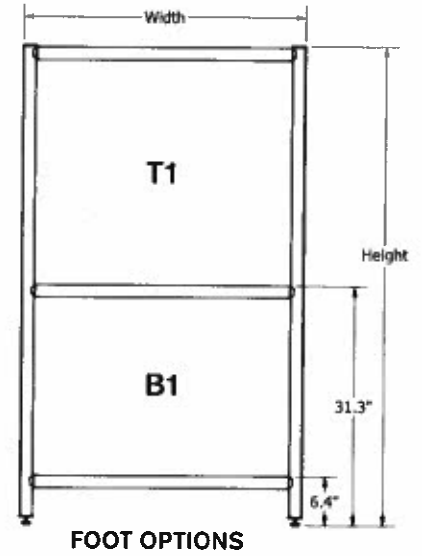

73" Width				T1 TOP CORE MATERIALS								
				FRO	CLR	WB	A1_	F1_	F2_	WBF1_	WBF2_	L1_
Width	Height	Weight (lbs)	Frame Base Price	Frosted Acrylic	Clear Acrylic	White-board	Colored Frosted Acrylic	Fabric 100 Series	Fabric 200 Series	WB/Fabric 100 Series	WB/Fabric 200 Series	Laminate 100 Series
73"	42"	29	\$710	+\$160	+\$160	+\$140	+\$270	+\$185	+\$230	+\$195	+\$215	+\$290
73"	48"	32	\$750	+\$270	+\$270	+\$270	+\$490	+\$245	+\$385	+\$255	+\$330	+\$390
73"	54"	35	\$785	+\$275	+\$275	+\$270	+\$490	+\$340	+\$430	+\$365	+\$410	+\$550
73"	62"	40	\$835	+\$495	+\$495	+\$535	+\$935	+\$610	+\$790	+\$680	+\$775	+\$725
73"	72"	45	\$900	+\$495	+\$495	+\$535	+\$940	+\$635	+\$815	+\$695	+\$785	+\$1,005

B1 - Lower core option for all 73" wide Duplex Walls (Height is 31" for all lower cores)	B1 LOWER CORE MATERIALS								
	FRO	CLR	WB	A1_	F1_	F2_	WBF1_	WBF2_	L1_
	Frosted Acrylic	Clear Acrylic	White-board	Colored Frosted	Fabric 100	Fabric 200	WB/Fabric 100	WB/Fabric 200	Laminate 100
	+\$490	+\$490	+\$295	+\$495	+\$345	+\$435	+\$365	+\$415	+\$550

FOOT OPTIONS						
4 Wheels	2 Wheels-1 Foot	2 Wheels-1 Leveler	Free-standing	1 Foot-1 Leveler	No Feet	2 Levelers
+\$180	+\$180	+\$90	+\$180	+\$90	+\$0	+\$0

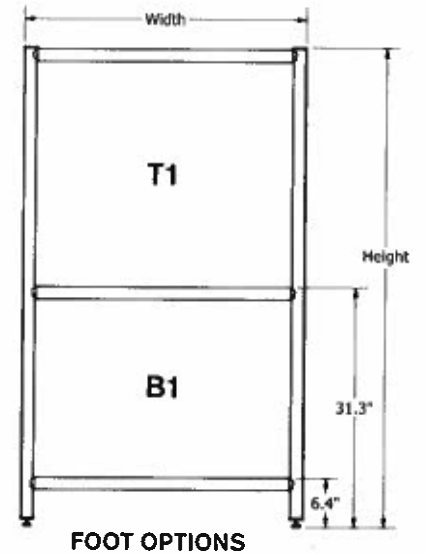

NOTE:
All pricing in USD

MODULAR SCREENS - NOTCH WALL

NotchWall - Satin Anodized Aluminum frame, 16" Floor foot, leveling glide, 5" WS foot

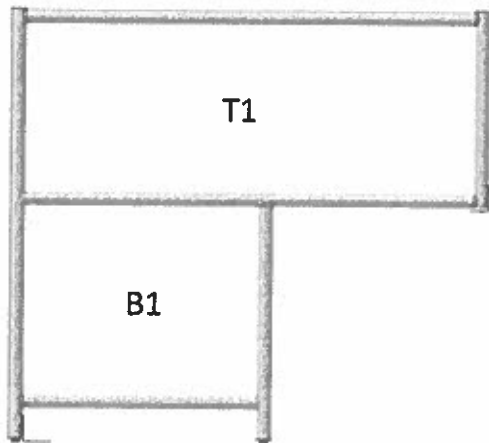

Clear Acrylic (CLR)
Frosted Acrylic (FRO)

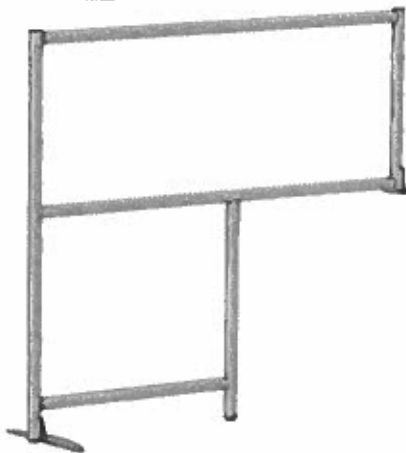

	Width	Height	WS Depth	LP
NW-485424-AA-F-T1__-B1__	48	54	24	\$1,085
NW-486224-AA-F-T1__-B1__	48	62	24	\$1,180
NW-487224-AA-F-T1__-B1__	48	72	24	\$1,325
NW-545424-AA-F-T1__-B1__	54	54	24	\$1,235
NW-545430-AA-F-T1__-B1__	54	54	30	\$1,235
NW-546224-AA-F-T1__-B1__	54	62	24	\$1,495
NW-546230-AA-F-T1__-B1__	54	62	30	\$1,495
NW-547224-AA-F-T1__-B1__	54	72	24	\$1,555
NW-547230-AA-F-T1__-B1__	54	72	30	\$1,555
NW-605424-AA-F-T1__-B1__	60	54	24	\$1,275
NW-605430-AA-F-T1__-B1__	60	54	30	\$1,275
NW-606224-AA-F-T1__-B1__	60	62	24	\$1,535
NW-606230-AA-F-T1__-B1__	60	62	30	\$1,535
NW-607224-AA-F-T1__-B1__	60	72	24	\$1,600
NW-607230-AA-F-T1__-B1__	60	72	30	\$1,600
NW-725424-AA-F-T1__-B1__	72	54	24	\$1,395
NW-725430-AA-F-T1__-B1__	72	54	30	\$1,395
NW-726224-AA-F-T1__-B1__	72	62	24	\$1,665
NW-726230-AA-F-T1__-B1__	72	62	30	\$1,665
NW-727224-AA-F-T1__-B1__	72	72	24	\$1,730
NW-727230-AA-F-T1__-B1__	72	72	30	\$1,730

ACCESSORIES

Room Dividers and Privacy Partitions



HGEUM
Universal Hinge Kit
Mobile Office Partitions

Universal Hinge Kit - Mobile Room Dividers and Office Partitions	SKU	Price
--	-----	-------

- Our Universal Hinge Kit can be used to create a 2-way, 3-way, or 4-way connection
- Designed for panels with mobile feet
- Designed for stationary panels with a height of 72" and taller
- The hinge design allows the angle between the partitions to be freely adjusted
- Metal construction with a durable anodized finish
- Kit includes 3 hinges

HGEUM \$60



HGEW
Wall Mount Hinge Kit

Wall Mount Hinge Kit	Qty of Wall Hinges	SKU	Price
----------------------	--------------------	-----	-------

42" - 72" High Partitions

3

HGEW

\$150

- Wall Mount Hinges attach one side of your Office Partition to a wall
- The hinge design provides 180 degrees of adjustment allowing the partition to come off the wall at any angle
- Includes mounting hardware for sheetrock walls

FOOT DETAILS



NF
No Feet

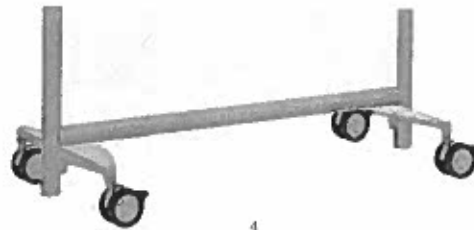

4
4 Wheels



2WF
2 Wheels-1 Foot



3WL
2 Wheels-1 Leveler



F
Freestanding



FL
1 Foot-1 Leveler



L
2 Levelers

FABRIC SERIES 100 (F1_)



Gaia
F101

Mikan
F103

Poppy
F104

Euro
F102

Sapphire
F114

Sodalite
F108

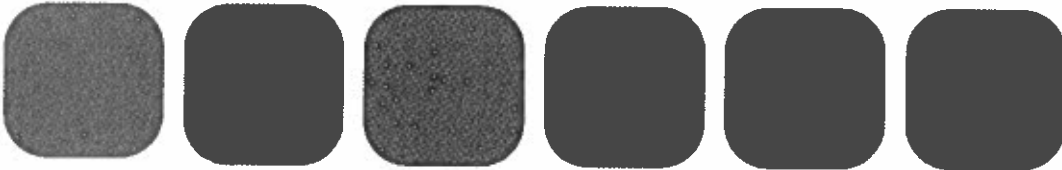

Arundel
F112

Iron
F121

Stately
F113

Steel
F120

Basalt
F122

Jett
F123

FABRIC SERIES 200 (F2_)

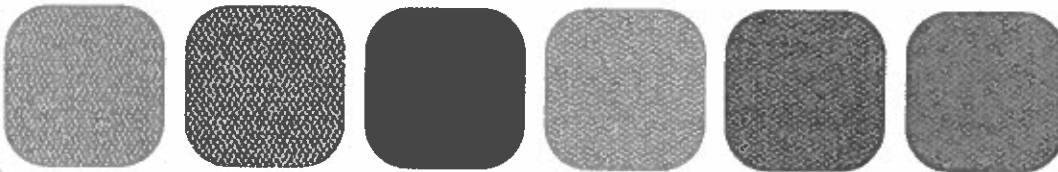

Barley
F210

Sable
F211

Java
F212

Lemongrass
F213

Rinse
F214

Radiant
F215

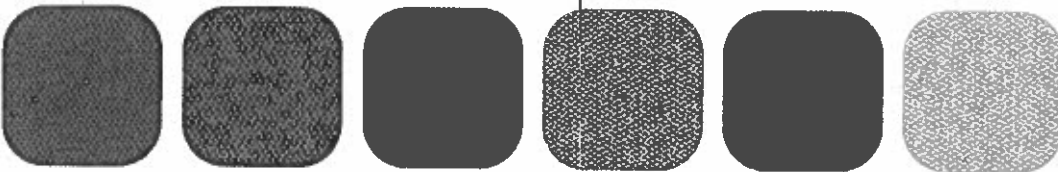

Tyrion
F216

Hyacinth
F217

Capri
F218

Aster
F219

Beyond
F220

Stucco
F221



Aluminum
F222

Dove
F223

Links
F224

Atoll
F225

Maize
F226

Papaya
F227

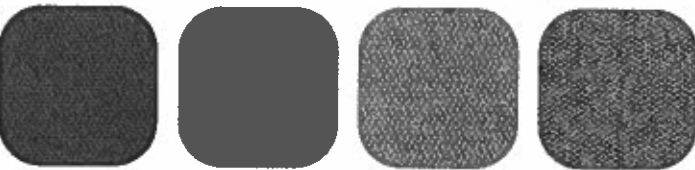

Macintosh
F228

Berry
F229

Gull
F230

Pewter
F231



COLORED FROSTED ACRYLICS (A1_)



LAMINATES AND WOODGRAINS SERIES 100 (L1_)

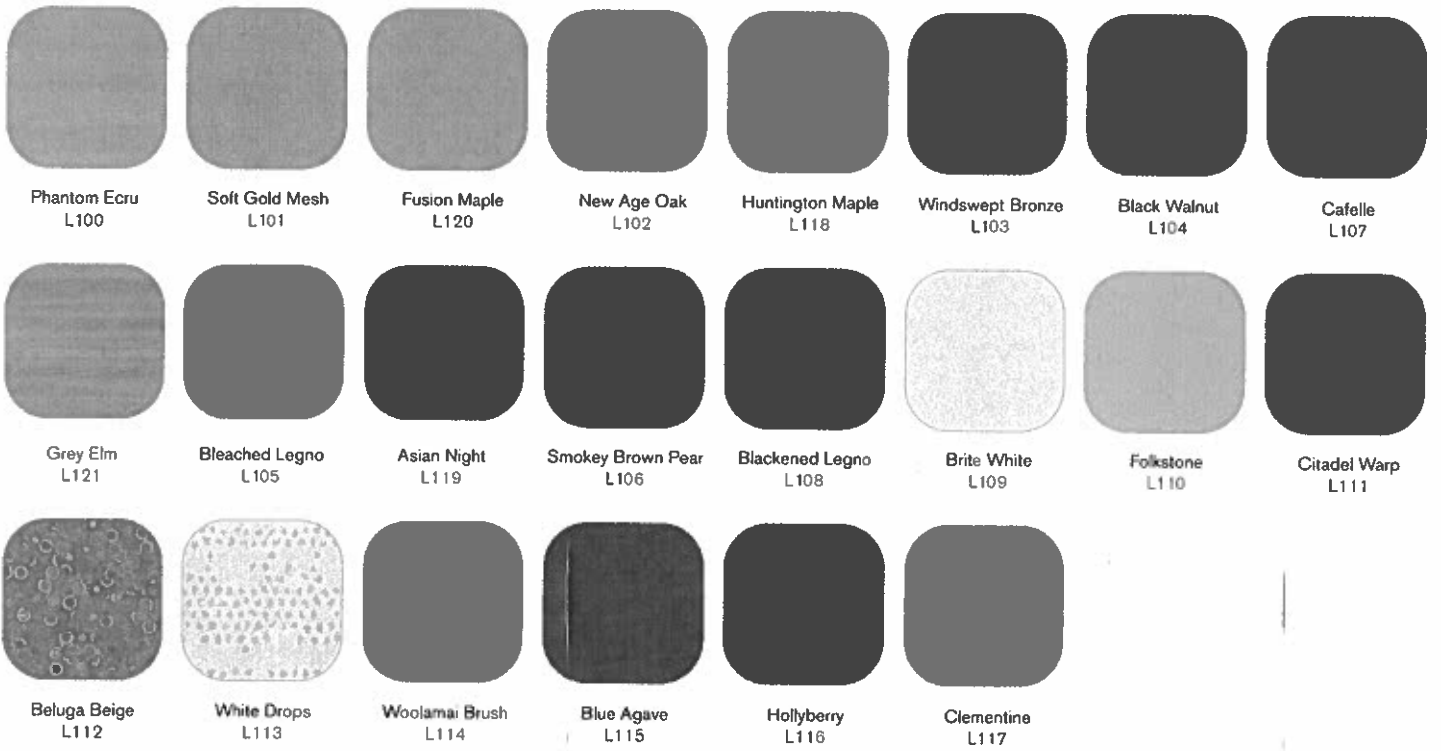

FRAME COLOR

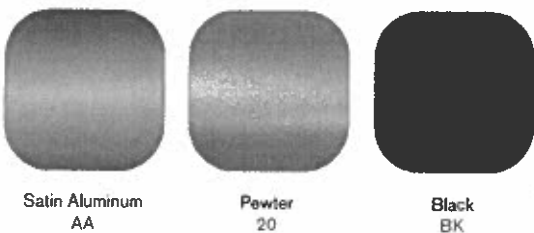

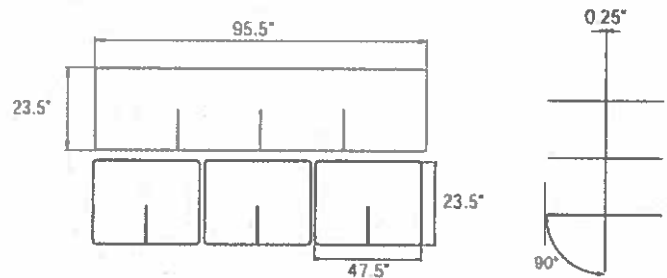
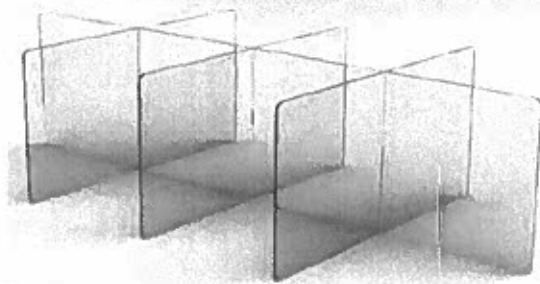
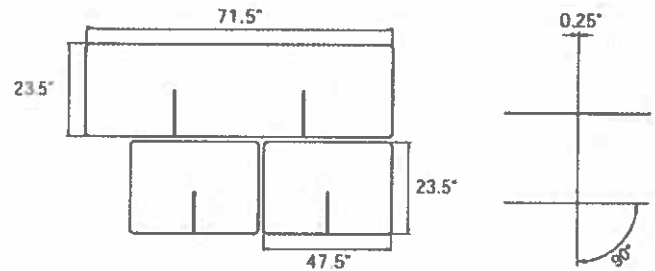
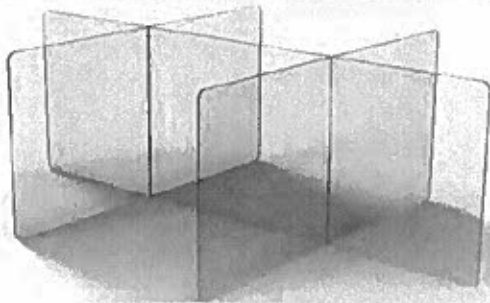
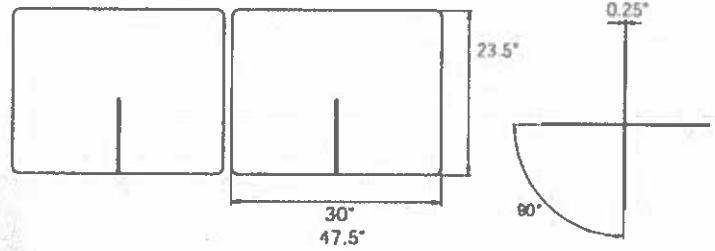
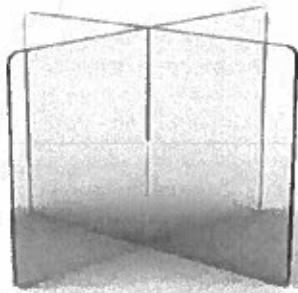

- Assembles in Seconds
- Custom Sizes Available
- Lightweight and Portable
- Easy to Clean and Disinfect
- Works Great for Both Circular and Rectangular Tables

Width	Height	Model Number	List
30"	23.5"	TD 1A	\$610.25
47.5"	23.5"	TD 1B	\$686.02
59"	23.5"	TD 1C	\$919.37
71.5"	23.5"	TD 2	\$1560.52
95.5"	23.5"	TD 3	\$1853.02



**STATE OF NEW JERSEY
DEPARTMENT OF THE TREASURY
DIVISION OF PURCHASE AND PROPERTY**

**33 WEST STATE STREET, P.O. BOX 230
TRENTON, NEW JERSEY 08625-0230**

State of New Jersey Standard Terms and Conditions

(Rev: 10/21/19)

1. STANDARD TERMS AND CONDITIONS APPLICABLE TO THE CONTRACT

Unless the bidder/offeror is specifically instructed otherwise in the Request for Proposals (RFP), the following terms and conditions shall apply to all contracts or purchase agreements made with the State of New Jersey. These terms are in addition to the terms and conditions set forth in the RFP and should be read in conjunction with same unless the RFP specifically indicates otherwise. In the event that the bidder/offeror would like to present terms and conditions that are in conflict with either these terms and conditions or those set forth in the RFP, the bidder/offeror must present those conflicts during the Question and Answer period for the State to consider. Any conflicting terms and conditions that the State is willing to accept will be reflected in an addendum to the RFP. The State's terms and conditions shall prevail over any conflicts set forth in a bidder/offeror's Proposal that were not submitted through the question and answer process and approved by the State. Nothing in these terms and conditions shall prohibit the Director of the Division of Purchase and Property (Director) from amending a contract when the Director determines it is in the best interests of the State.

1.1 CONTRACT TERMS CROSSWALK

NJSTART Term	Equivalent Statutory, Regulatory and/or Legacy Term
Bid/Bid Solicitation	Request For Proposal (RFP)/Solicitation
Bid Amendment	Addendum
Change Order	Contract Amendment
Master Blanket Purchase Order (Blanket P.O.)	Contract
Offer and Acceptance Page	Signatory Page
Quote	Proposal
Vendor	Bidder/Contractor

2. STATE LAW REQUIRING MANDATORY COMPLIANCE BY ALL CONTRACTORS

The statutes, laws or codes cited herein are available for review at the New Jersey State Library, 185 West State Street, Trenton, New Jersey 08625.

2.1 BUSINESS REGISTRATION

Pursuant to N.J.S.A. 52:32-44, the State is prohibited from entering into a contract with an entity unless the bidder and each subcontractor named in the proposal have a valid Business Registration Certificate on file with the Division of Revenue and Enterprise Services. A subcontractor named in a bid or other proposal shall provide a copy of its business registration to the bidder who shall provide it to the State.

The contractor shall maintain and submit to the State a list of subcontractors and their addresses that may be updated from time to time with the prior written consent of the Director during the course of contract performance. The contractor shall submit to the State a complete and accurate list of all subcontractors used and their addresses before final payment is made under the contract.

Pursuant to N.J.S.A. 54:49-4.1, a business organization that fails to provide a copy of a business registration, or that provides false business registration information, shall be liable for a penalty of

\$25 for each day of violation, not to exceed \$50,000 for each business registration copy not properly provided under a contract with a contracting agency.

The contractor and any subcontractor providing goods or performing services under the contract, and each of their affiliates, shall, during the term of the contract, collect and remit to the Director of the Division of Taxation in the Department of the Treasury, the Use Tax due pursuant to the "Sales and Use Tax Act, P.L. 1966, c. 30 (N.J.S.A. 54:32B-1 et seq.) on all sales of tangible personal property delivered into the State. Any questions in this regard can be directed to the Division of Revenue at (609) 292-1730. Form NJ-REG can be filed online at <http://www.state.nj.us/treasury/revenue/busregcert.shtml>.

2.2 ANTI-DISCRIMINATION

All parties to any contract with the State agree not to discriminate in employment and agree to abide by all anti-discrimination laws including those contained within N.J.S.A. 10:2-1 through N.J.S.A. 10:2-4, N.J.S.A. 10:5-1 et seq. and N.J.S.A. 10:5-31 through 10:5-38, and all rules and regulations issued thereunder are hereby incorporated by reference. The agreement to abide by the provisions of N.J.S.A. 10:5-31 through 10:5-38 include those provisions indicated for Goods, Professional Service and General Service Contracts (Exhibit A, attached) and Constructions Contracts (Exhibit B and Executive Order 151, August 28, 2009, attached) as appropriate.

The contractor or subcontractor, where applicable, agrees to comply with any regulations promulgated by the Treasurer pursuant to N.J.S.A. 10:5-31 et seq., as amended and supplemented from time to time.

2.3 PREVAILING WAGE ACT

The New Jersey Prevailing Wage Act, N.J.S.A. 34: 11-56.25 et seq. is hereby made part of every contract entered into on behalf of the State of New Jersey through the Division of Purchase and Property, except those contracts which are not within the contemplation of the Act. The bidder's signature on [this proposal] is his/her guarantee that neither he/she nor any subcontractors he/she might employ to perform the work covered by [this proposal] has been suspended or debarred by the Commissioner, Department of Labor and Workforce Development for violation of the provisions of the Prevailing Wage Act and/or the Public Works Contractor Registration Acts; the bidder's signature on the proposal is also his/her guarantee that he/she and any subcontractors he/she might employ to perform the work covered by [this proposal] shall comply with the provisions of the Prevailing Wage and Public Works Contractor Registration Acts, where required.

2.4 AMERICANS WITH DISABILITIES ACT

The contractor must comply with all provisions of the Americans with Disabilities Act (ADA), P.L. 101-336, in accordance with 42 U.S.C. 12101, et seq.

2.5 MACBRIDE PRINCIPLES

The bidder must certify pursuant to N.J.S.A. 52:34-12.2 that it either has no ongoing business activities in Northern Ireland and does not maintain a physical presence therein or that it will take lawful steps in good faith to conduct any business operations it has in Northern Ireland in accordance with the MacBride principles of nondiscrimination in employment as set forth in N.J.S.A. 52:18A-89.5 and in conformance with the United Kingdom's Fair Employment (Northern Ireland) Act of 1989, and permit independent monitoring of their compliance with those principles.

2.6 PAY TO PLAY PROHIBITIONS

Pursuant to N.J.S.A. 19:44A-20.13 et seq. (P.L. 2005, c. 51), and specifically, N.J.S.A. 19:44A-20.21, it shall be a breach of the terms of the contract for the business entity to:

- A. Make or solicit a contribution in violation of the statute;
- B. Knowingly conceal or misrepresent a contribution given or received;

- C. Make or solicit contributions through intermediaries for the purpose of concealing or misrepresenting the source of the contribution;
- D. Make or solicit any contribution on the condition or with the agreement that it will be contributed to a campaign committee or any candidate or holder of the public office of Governor or Lieutenant Governor, or to any State or county party committee;
- E. Engage or employ a lobbyist or consultant with the intent or understanding that such lobbyist or consultant would make or solicit any contribution, which if made or solicited by the business entity itself, would subject that entity to the restrictions of the Legislation;
- F. Fund contributions made by third parties, including consultants, attorneys, family members, and employees;
- G. Engage in any exchange of contributions to circumvent the intent of the Legislation; or
- H. Directly or indirectly through or by any other person or means, do any act which would subject that entity to the restrictions of the Legislation.

2.7 POLITICAL CONTRIBUTION DISCLOSURE

The contractor is advised of its responsibility to file an annual disclosure statement on political contributions with the New Jersey Election Law Enforcement Commission (ELEC), pursuant to N.J.S.A. 19:44A-20.27 (P.L. 2005, c. 271, §3 as amended) if in a calendar year the contractor receives one (1) or more contracts valued at \$50,000.00 or more. It is the contractor's responsibility to determine if filing is necessary. Failure to file can result in the imposition of penalties by ELEC. Additional information about this requirement is available from ELEC by calling 1(888)313-3532 or on the internet at <http://www.elec.state.nj.us/>.

2.8 STANDARDS PROHIBITING CONFLICTS OF INTEREST

The following prohibitions on contractor activities shall apply to all contracts or purchase agreements made with the State of New Jersey, pursuant to Executive Order No. 189 (1988).

No vendor shall pay, offer to pay, or agree to pay, either directly or indirectly, any fee, commission, compensation, gift, gratuity, or other thing of value of any kind to any State officer or employee or special State officer or employee, as defined by N.J.S.A. 52:13D-13b. and e., in the Department of the Treasury or any other agency with which such vendor transacts or offers or proposes to transact business, or to any member of the immediate family, as defined by N.J.S.A. 52:13D-13i., of any such officer or employee, or partnership, firm or corporation with which they are employed or associated, or in which such officer or employee has an interest within the meaning of N.J.S.A. 52:13D-13g;

The solicitation of any fee, commission, compensation, gift, gratuity or other thing of value by any State officer or employee or special State officer or employee from any State vendor shall be reported in writing forthwith by the vendor to the New Jersey Office of the Attorney General and the Executive Commission on Ethical Standards, now known as the State Ethics Commission;

No vendor may, directly or indirectly, undertake any private business, commercial or entrepreneurial relationship with, whether or not pursuant to employment, contract or other agreement, express or implied, or sell any interest in such vendor to, any State officer or employee or special State officer or employee having any duties or responsibilities in connection with the purchase, acquisition or sale of any property or services by or to any State agency or any instrumentality thereof, or with any person, firm or entity with which he/she is employed or associated or in which he/she has an interest within the meaning of N.J.S.A. 52:13D-13g. Any relationships subject to this provision shall be reported in writing forthwith to the Executive Commission on Ethical Standards, now known as the State Ethics Commission, which may grant a waiver of this restriction upon application of the State officer or employee or special State officer or employee upon a finding that the present or proposed relationship does not present the potential, actuality or appearance of a conflict of interest;

No vendor shall influence, or attempt to influence or cause to be influenced, any State officer or employee or special State officer or employee in his/her official capacity in any manner which might tend to impair the objectivity or independence of judgment of said officer or employee;

No vendor shall cause or influence, or attempt to cause or influence, any State officer or employee or special State officer or employee to use, or attempt to use, his/her official position to secure unwarranted privileges or advantages for the vendor or any other person; and

The provisions cited above in paragraphs 2.8a through 2.8e shall not be construed to prohibit a State officer or employee or Special State officer or employee from receiving gifts from or contracting with vendors under the same terms and conditions as are offered or made available to members of the general public subject to any guidelines the Executive Commission on Ethical Standards, now known as the State Ethics Commission may promulgate under paragraph 3c of Executive Order No. 189.

2.9 NOTICE TO ALL CONTRACTORS SET-OFF FOR STATE TAX NOTICE

Pursuant to N.J.S.A. 54:49-19, effective January 1, 1996, and notwithstanding any provision of the law to the contrary, whenever any taxpayer, partnership or S corporation under contract to provide goods or services or construction projects to the State of New Jersey or its agencies or instrumentalities, including the legislative and judicial branches of State government, is entitled to payment for those goods or services at the same time a taxpayer, partner or shareholder of that entity is indebted for any State tax, the Director of the Division of Taxation shall seek to set off that taxpayer's or shareholder's share of the payment due the taxpayer, partnership, or S corporation. The amount set off shall not allow for the deduction of any expenses or other deductions which might be attributable to the taxpayer, partner or shareholder subject to set-off under this act.

The Director of the Division of Taxation shall give notice to the set-off to the taxpayer and provide an opportunity for a hearing within 30 days of such notice under the procedures for protests established under R.S. 54:49-18. No requests for conference, protest, or subsequent appeal to the Tax Court from any protest under this section shall stay the collection of the indebtedness. Interest that may be payable by the State, pursuant to P.L. 1987, c.184 (c.52:32-32 et seq.), to the taxpayer shall be stayed.

2.10 COMPLIANCE - LAWS

The contractor must comply with all local, State and Federal laws, rules and regulations applicable to this contract and to the goods delivered and/or services performed hereunder.

2.11 COMPLIANCE - STATE LAWS

It is agreed and understood that any contracts and/or orders placed as a result of [this proposal] shall be governed and construed and the rights and obligations of the parties hereto shall be determined in accordance with the laws of the State of New Jersey.

2.12 WARRANTY OF NO SOLICITATION ON COMMISSION OR CONTINGENT FEE BASIS

The contractor warrants that no person or selling agency has been employed or retained to solicit or secure the contract upon an agreement or understanding for a commission, percentage, brokerage or contingent fee, except bona fide employees or bona fide established commercial or selling agencies maintained by the contractor for the purpose of securing business. If a breach or violation of this section occurs, the State shall have the right to terminate the contract without liability or in its discretion to deduct from the contract price or consideration the full amount of such commission, percentage, brokerage or contingent fee.

3. STATE LAW REQUIRING MANDATORY COMPLIANCE BY CONTRACTORS UNDER CIRCUMSTANCES SET FORTH IN LAW OR BASED ON THE TYPE OF CONTRACT

3.1 COMPLIANCE - CODES

The contractor must comply with NJUCC and the latest NEC70, B.O.C.A. Basic Building code, OSHA and all applicable codes for this requirement. The contractor shall be responsible for securing and paying all necessary permits, where applicable.

3.2 PUBLIC WORKS CONTRACTOR REGISTRATION ACT

The New Jersey Public Works Contractor Registration Act requires all contractors, subcontractors and lower tier subcontractor(s) who engage in any contract for public work as defined in N.J.S.A. 34:11-56.26 be first registered with the New Jersey Department of Labor and Workforce Development pursuant to N.J.S.A. 34:11-56.51. Any questions regarding the registration process should be directed to the Division of Wage and Hour Compliance at (609) 292-9464.

3.3 PUBLIC WORKS CONTRACT - ADDITIONAL AFFIRMATIVE ACTION REQUIREMENTS

N.J.S.A. 10:2-1 requires that during the performance of this contract, the contractor must agree as follows:

- A. In the hiring of persons for the performance of work under this contract or any subcontract hereunder, or for the procurement, manufacture, assembling or furnishing of any such materials, equipment, supplies or services to be acquired under this contract, no contractor, nor any person acting on behalf of such contractor or subcontractor, shall, by reason of race, creed, color, national origin, ancestry, marital status, gender identity or expression, affectional or sexual orientation or sex, discriminate against any person who is qualified and available to perform the work to which the employment relates;
- B. No contractor, subcontractor, nor any person on his/her behalf shall, in any manner, discriminate against or intimidate any employee engaged in the performance of work under this contract or any subcontract hereunder, or engaged in the procurement, manufacture, assembling or furnishing of any such materials, equipment, supplies or services to be acquired under such contract, on account of race, creed, color, national origin, ancestry, marital status, gender identity or expression, affectional or sexual orientation or sex;
- C. There may be deducted from the amount payable to the contractor by the contracting public agency, under this contract, a penalty of \$50.00 for each person for each calendar day during which such person is discriminated against or intimidated in violation of the provisions of the contract; and
- D. This contract may be canceled or terminated by the contracting public agency, and all money due or to become due hereunder may be forfeited, for any violation of this section of the contract occurring after notice to the contractor from the contracting public agency of any prior violation of this section of the contract.

N.J.S.A. 10:5-33 and N.J.A.C. 17:27-3.5 require that during the performance of this contract, the contractor must agree as follows:

- A. The contractor or subcontractor, where applicable, will not discriminate against any employee or applicant for employment because of age, race, creed, color, national origin, ancestry, marital status, affectional or sexual orientation, gender identity or expression, disability, nationality or sex. Except with respect to affectional or sexual orientation and gender identity or expression, the contractor will take affirmative action to ensure that such applicants are recruited and employed, and that employees are treated during employment, without regard to their age, race, creed, color, national origin, ancestry, marital status, affectional or sexual orientation, gender identity or expression, disability, nationality or sex. Such action shall include, but not be limited to the following: employment, upgrading, demotion, or transfer; recruitment or recruitment

advertising; layoff or termination; rates of pay or other forms of compensation; and selection for training, including apprenticeship. The contractor agrees to post in conspicuous places, available to employees and applicants for employment, notices to be provided by the contracting officer setting forth the provisions of this nondiscrimination clause;

- B. The contractor or subcontractor, where applicable will, in all solicitations or advertisements for employees placed by or on behalf of the contractor, state that all qualified applicants will receive consideration for employment without regard to age, race, creed, color, national origin, ancestry, marital status, affectional or sexual orientation, gender identity or expression, disability, nationality or sex;
- C. The contractor or subcontractor where applicable, will send to each labor union or representative of workers with which it has a collective bargaining agreement or other contract or understanding, a notice, to be provided by the agency contracting officer, advising the labor union or workers' representative of the contractor's commitments under this act and shall post copies of the notice in conspicuous places available to employees and applicants for employment, N.J.A.C. 17:27-3.7 requires all contractors and subcontractors, if any, to further agree as follows:
1. The contractor or subcontractor agrees to make good faith efforts to meet targeted county employment goals established in accordance with N.J.A.C. 17:27-5.2;
 2. The contractor or subcontractor agrees to inform in writing its appropriate recruitment agencies including, but not limited to, employment agencies, placement bureaus, colleges, universities, and labor unions, that it does not discriminate on the basis of age, race, creed, color, national origin, ancestry, marital status, affectional or sexual orientation, gender identity or expression, disability, nationality or sex, and that it will discontinue the use of any recruitment agency which engages in direct or indirect discriminatory practices;
 3. The contractor or subcontractor agrees to revise any of its testing procedures, if necessary, to assure that all personnel testing conforms with the principles of job-related testing, as established by the statutes and court decisions of the State of New Jersey and as established by applicable Federal law and applicable Federal court decisions; and
 4. In conforming with the targeted employment goals, the contractor or subcontractor agrees to review all procedures relating to transfer, upgrading, downgrading and layoff to ensure that all such actions are taken without regard to age, race, creed, color, national origin, ancestry, marital status, affectional or sexual orientation, gender identity or expression, disability, nationality or sex, consistent with the statutes and court decisions of the State of New Jersey, and applicable Federal law and applicable Federal court decisions.

3.4 BUILDING SERVICE

Pursuant to N.J.S.A. 34:11-56.58 et seq., in any contract for building services, as defined in N.J.S.A. 34:11-56.59, the employees of the contractor or subcontractors shall be paid prevailing wage for building services rates, as defined in N.J.S.A. 34:11.56.59. The prevailing wage shall be adjusted annually during the term of the contract.

3.5 THE WORKER AND COMMUNITY RIGHT TO KNOW ACT

The provisions of N.J.S.A. 34:5A-1 et seq. which require the labeling of all containers of hazardous substances are applicable to this contract. Therefore, all goods offered for purchase to the State must be labeled by the contractor in compliance with the provisions of the statute.

3.6 SERVICE PERFORMANCE WITHIN U.S.

Under N.J.S.A. 52:34-13.2, all contracts primarily for services awarded by the Director shall be performed within the United States, except when the Director certifies in writing a finding that a

required service cannot be provided by a contractor or subcontractor within the United States and the certification is approved by the State Treasurer.

A shift to performance of services outside the United States during the term of the contract shall be deemed a breach of contract. If, during the term of the contract, the contractor or subcontractor, proceeds to shift the performance of any of the services outside the United States, the contractor shall be deemed to be in breach of its contract, which contract shall be subject to termination for cause pursuant to Section 5.7(b) (1) of the Standard Terms and Conditions, unless previously approved by the Director and the Treasurer.

3.7 BUY AMERICAN

Pursuant to N.J.S.A. 52:32-1, if manufactured items or farm products will be provided under this contract to be used in a public work, they shall be manufactured or produced in the United States and the contractor shall be required to so certify.

3.8 DIANE B. ALLEN EQUAL PAY ACT

Pursuant to N.J.S.A. 34:11-56.14, a contractor performing "qualifying services" or "public work" to the State or any agency or instrumentality of the State shall provide the Commissioner of Labor and Workforce Development a report regarding the compensation and hours worked by employees categorized by gender, race, ethnicity, and job category. For more information and report templates see <https://nj.gov/labor/equalpay/equalpay.html>.

4. INDEMNIFICATION AND INSURANCE

4.1 INDEMNIFICATION

The contractor's liability to the State and its employees in third party suits shall be as follows:

- A. Indemnification for Third Party Claims - The contractor shall assume all risk of and responsibility for, and agrees to indemnify, defend, and save harmless the State of New Jersey and its employees from and against any and all claims, demands, suits, actions, recoveries, judgments and costs and expenses in connection therewith which shall arise from or result directly or indirectly from the work and/or materials supplied under this contract, including liability of any nature or kind for or on account of the use of any copyrighted or uncopyrighted composition, secret process, patented or unpatented invention, article or appliance furnished or used in the performance of this contract;
- B. The contractor's indemnification and liability under subsection (a) is not limited by, but is in addition to the insurance obligations contained in Section 4.2 of these Terms and Conditions; and
- C. In the event of a patent and copyright claim or suit, the contractor, at its option, may: (1) procure for the State of New Jersey the legal right to continue the use of the product; (2) replace or modify the product to provide a non-infringing product that is the functional equivalent; or (3) refund the purchase price less a reasonable allowance for use that is agreed to by both parties.

4.2 INSURANCE

The contractor shall secure and maintain in force for the term of the contract insurance as provided herein. All required insurance shall be provided by insurance companies with an A-VIII or better rating by A.M. Best & Company. All policies must be endorsed to provide 30 days' written notice of cancellation or material change to the State of New Jersey at the address shown below. If the contractor's insurer cannot provide 30 days written notice, then it will become the obligation of the contractor to provide the same. The contractor shall provide the State with current certificates of insurance for all coverages and renewals thereof. Renewal certificates shall be provided within 30 days of the expiration of the insurance. The contractor shall not begin to provide services or goods to the State until evidence of the required insurance is provided. The certificates of insurance shall indicate the contract number or purchase order number and title of the contract in the Description

of Operations box and shall list the State of New Jersey, Department of the Treasury, Division of Purchase & Property, Contract Compliance & Audit Unit, P.O. Box 236, Trenton, New Jersey 08625 in the Certificate Holder box. The certificates and any notice of cancelation shall be emailed to the State at:

cca.certificate@treas.nj.gov

The insurance to be provided by the contractor shall be as follows:

- A. Occurrence Form Commercial General Liability Insurance or its equivalent: The minimum limit of liability shall be \$1,000,000 per occurrence as a combined single limit for bodily injury and property damage. The above required Commercial General Liability Insurance policy or its equivalent shall name the State, its officers, and employees as "Additional Insureds" and include the blanket additional insured endorsement or its equivalent. The coverage to be provided under these policies shall be at least as broad as that provided by the standard basic Commercial General Liability Insurance occurrence coverage forms or its equivalent currently in use in the State of New Jersey, which shall not be circumscribed by any endorsement limiting the breadth of coverage;
- B. Automobile Liability Insurance which shall be written to cover any automobile used by the insured. Limits of liability for bodily injury and property damage shall not be less than \$1,000,000 per occurrence as a combined single limit. The State must be named as an "Additional Insured" and a blanket additional insured endorsement or its equivalent must be provided when the services being procured involve vehicle use on the State's behalf or on State controlled property;
- C. Worker's Compensation Insurance applicable to the laws of the State of New Jersey and Employers Liability Insurance with limits not less than:
 1. \$1,000,000 BODILY INJURY, EACH OCCURRENCE;
 2. \$1,000,000 DISEASE EACH EMPLOYEE; and
 3. \$1,000,000 DISEASE AGGREGATE LIMIT.
 - A. This \$1,000,000 amount may have been raised by the RFP when deemed necessary by the Director; and
 - B. In the case of a contract entered into pursuant to N.J.S.A. 52:32-17 et seq., (small business set asides) the minimum amount of insurance coverage in subsections a., b., and c. above may have been lowered in the RFP for certain commodities when deemed in the best interests of the State by the Director.

5. TERMS GOVERNING ALL CONTRACTS

5.1 CONTRACTOR IS INDEPENDENT CONTRACTOR

The contractor's status shall be that of any independent contractor and not as an employee of the State.

5.2 CONTRACT AMOUNT

The estimated amount of the contract(s), when stated on the RFP form, shall not be construed as either the maximum or minimum amount which the State shall be obliged to order as the result of the RFP or any contract entered into as a result of the RFP.

5.3 CONTRACT TERM AND EXTENSION OPTION

If, in the opinion of the Director, it is in the best interest of the State to extend a contract, the contractor shall be so notified of the Director's Intent at least 30 days prior to the expiration date of the existing contract. The contractor shall have 15 calendar days to respond to the Director's request to extend the term and period of performance of the contract. If the contractor agrees to the

extension, all terms and conditions of the original contract shall apply unless more favorable terms for the State have been negotiated.

5.4 STATE'S OPTION TO REDUCE SCOPE OF WORK

The State has the option, in its sole discretion, to reduce the scope of work for any deliverable, task or subtask called for under this contract. In such an event, the Director shall provide to the contractor advance written notice of the change in scope of work and what the Director believes should be the corresponding adjusted contract price. Within five (5) business days of receipt of such written notice, if either is applicable:

- A. If the contractor does not agree with the Director's proposed adjusted contract price, the contractor shall submit to the Director any additional information that the contractor believes impacts the adjusted contract price with a request that the Director reconsider the proposed adjusted contract price. The parties shall negotiate the adjusted contract price. If the parties are unable to agree on an adjusted contract price, the Director shall make a prompt decision taking all such information into account, and shall notify the contractor of the final adjusted contract price; and
- B. If the contractor has undertaken any work effort toward a deliverable, task or subtask that is being changed or eliminated such that it would not be compensated under the adjusted contract, the contractor shall be compensated for such work effort according to the applicable portions of its price schedule and the contractor shall submit to the Director an itemization of the work effort already completed by deliverable, task or subtask within the scope of work, and any additional information the Director may request. The Director shall make a prompt decision taking all such information into account, and shall notify the contractor of the compensation to be paid for such work effort.

5.5 CHANGE IN LAW

If, after award, a change in applicable law or regulation occurs which affects the Contract, the parties may amend the Contract, including pricing, in order to provide equitable relief for the party disadvantaged by the change in law. The parties shall negotiate in good faith, however if agreement is not possible after reasonable efforts, the Director shall make a prompt decision as to an equitable adjustment, taking all relevant information into account, and shall notify the Vendor {Contractor} of the final adjusted contract price.

5.6 SUSPENSION OF WORK

The State may, for valid reason, issue a stop order directing the contractor to suspend work under the contract for a specific time. The contractor shall be paid for goods ordered, goods delivered, or services requested and performed until the effective date of the stop order. The contractor shall resume work upon the date specified in the stop order, or upon such other date as the State Contract Manager may thereafter direct in writing. The period of suspension shall be deemed added to the contractor's approved schedule of performance. The Director shall make an equitable adjustment, if any is required, to the contract price. The contractor shall provide whatever information that Director may require related to the equitable adjustment.

5.7 TERMINATION OF CONTRACT

- A. For Convenience:
Notwithstanding any provision or language in this contract to the contrary, the Director may terminate this contract at any time, in whole or in part, for the convenience of the State, upon no less than 30 days written notice to the contractor;
- B. For Cause:
 1. Where a contractor fails to perform or comply with a contract or a portion thereof, and/or fails to comply with the complaints procedure in N.J.A.C. 17:12-4.2 et seq., the Director

may terminate the contract, in whole or in part, upon ten (10) days' notice to the contractor with an opportunity to respond; and

2. Where in the reasonable opinion of the Director, a contractor continues to perform a contract poorly as demonstrated by e.g., formal complaints, late delivery, poor performance of service, short-shipping, so that the Director is required to use the complaints procedure in N.J.A.C. 17:12-4.2 et seq., and there has been a failure on the part of the contractor to make progress towards ameliorating the issue(s) or problem(s) set forth in the complaint, the Director may terminate the contract, in whole or in part, upon ten (10) days' notice to the contractor with an opportunity to respond.
- C. In cases of emergency the Director may shorten the time periods of notification and may dispense with an opportunity to respond; and
 - D. In the event of termination under this section, the contractor shall be compensated for work performed in accordance with the contract, up to the date of termination. Such compensation may be subject to adjustments.

5.8 SUBCONTRACTING OR ASSIGNMENT

- A. **Subcontracting**: The contractor may not subcontract other than as identified in the contractor's proposal without the prior written consent of the Director. Such consent, if granted in part, shall not relieve the contractor of any of his/her responsibilities under the contract, nor shall it create privity of contract between the State and any subcontractor. If the contractor uses a subcontractor to fulfill any of its obligations, the contractor shall be responsible for the subcontractor's: (a) performance; (b) compliance with all of the terms and conditions of the contract; and (c) compliance with the requirements of all applicable laws; and
- B. **Assignment**: The contractor may not assign its responsibilities under the contract, in whole or in part, without the prior written consent of the Director.

5.9 NO CONTRACTUAL RELATIONSHIP BETWEEN SUBCONTRACTORS AND STATE

Nothing contained in any of the contract documents, including the RFP and vendor's bid or proposal shall be construed as creating any contractual relationship between any subcontractor and the State.

5.10 MERGERS, ACQUISITIONS

If, during the term of this contract, the contractor shall merge with or be acquired by another firm, the contractor shall give notice to the Director as soon as practicable and in no event longer than 30 days after said merger or acquisition. The contractor shall provide such documents as may be requested by the Director, which may include but need not be limited to the following: corporate resolutions prepared by the awarded contractor and new entity ratifying acceptance of the original contract, terms, conditions and prices; updated information including ownership disclosure and Federal Employer Identification Number. The documents must be submitted within 30 days of the request. Failure to do so may result in termination of the contract for cause.

If, at any time during the term of the contract, the contractor's partnership, limited liability company, limited liability partnership, professional corporation, or corporation shall dissolve, the Director must be so notified. All responsible parties of the dissolved business entity must submit to the Director in writing, the names of the parties proposed to perform the contract, and the names of the parties to whom payment should be made. No payment shall be made until all parties to the dissolved business entity submit the required documents to the Director.

5.11 PERFORMANCE GUARANTEE OF CONTRACTOR

The contractor hereby certifies that:

- a. The equipment offered is standard new equipment, and is the manufacturer's latest model in production, with parts regularly used for the type of equipment offered; that such parts are all in production and not likely to be discontinued; and that no attachment or part has been substituted or applied contrary to manufacturer's recommendations and standard practice;
- b. All equipment supplied to the State and operated by electrical current is UL listed where applicable;
- c. All new machines are to be guaranteed as fully operational for the period stated in the contract from time of written acceptance by the State. The contractor shall render prompt service without charge, regardless of geographic location;
- d. Sufficient quantities of parts necessary for proper service to equipment shall be maintained at distribution points and service headquarters;
- e. Trained mechanics are regularly employed to make necessary repairs to equipment in the territory from which the service request might emanate within a 48-hour period or within the time accepted as industry practice;
- f. During the warranty period the contractor shall replace immediately any material which is rejected for failure to meet the requirements of the contract; and
- g. All services rendered to the State shall be performed in strict and full accordance with the specifications stated in the contract. The contract shall not be considered complete until final approval by the State's using agency is rendered.

5.12 DELIVERY REQUIREMENTS

- A. Deliveries shall be made at such time and in such quantities as ordered in strict accordance with conditions contained in the contract;
- B. The contractor shall be responsible for the delivery of material in first class condition to the State's using agency or the purchaser under this contract and in accordance with good commercial practice;
- C. Items delivered must be strictly in accordance with the contract; and
- D. In the event delivery of goods or services is not made within the number of days stipulated or under the schedule defined in the contract, the using agency shall be authorized to obtain the material or service from any available source, the difference in price, if any, to be paid by the contractor.

5.13 APPLICABLE LAW AND JURISDICTION

This contract and any and all litigation arising therefrom or related thereto shall be governed by the applicable laws, regulations and rules of evidence of the State of New Jersey without reference to conflict of laws principles and shall be filed in the appropriate Division of the New Jersey Superior Court.

5.14 CONTRACT AMENDMENT

Except as provided herein, the contract may only be amended by written agreement of the State and the contractor.

5.15 MAINTENANCE OF RECORDS

The contractor shall maintain records for products and/or services delivered against the contract for a period of five (5) years from the date of final payment unless a longer period is required by law. Such records shall be made available to the State, including the Comptroller, for audit and review.

5.16 ASSIGNMENT OF ANTITRUST CLAIM(S)

The contractor recognizes that in actual economic practice, overcharges resulting from antitrust violations are in fact usually borne by the ultimate purchaser. Therefore, and as consideration for executing this contract, the contractor, acting herein by and through its duly authorized agent, hereby conveys, sells, assigns, and transfers to the State of New Jersey, for itself and on behalf of its political subdivisions and public agencies, all right, title and interest to all claims and causes of action it may now or hereafter acquire under the antitrust laws of the United States or the State of New Jersey, relating to the particular goods and services purchased or acquired by the State of New Jersey or any of its political subdivisions or public agencies pursuant to this contract.

In connection with this assignment, the following are the express obligations of the contractor:

- A. It shall take no action that will in any way diminish the value of the rights conveyed or assigned hereunder;
- B. It shall advise the Attorney General of New Jersey:
 - 1. In advance of its intention to commence any action on its own behalf regarding any such claim or cause(s) of action; and
 - 2. Immediately upon becoming aware of the fact that an action has been commenced on its behalf by some other person(s) of the pendency of such action.
- C. It shall notify the defendants in any antitrust suit of the within assignment at the earliest practicable opportunity after the contractor has initiated an action on its own behalf or becomes aware that such an action has been filed on its behalf by another person. A copy of such notice shall be sent to the Attorney General of New Jersey; and
- D. It is understood and agreed that in the event any payment under any such claim or cause of action is made to the contractor, it shall promptly pay over to the State of New Jersey the allotted share thereof, if any, assigned to the State hereunder.

6. TERMS RELATING TO PRICE AND PAYMENT

6.1 PRICE FLUCTUATION DURING CONTRACT

Unless otherwise agreed to in writing by the State, all prices quoted shall be firm through issuance of contract or purchase order and shall not be subject to increase during the period of the contract. In the event of a manufacturer's or contractor's price decrease during the contract period, the State shall receive the full benefit of such price reduction on any undelivered purchase order and on any subsequent order placed during the contract period. The Director must be notified, in writing, of any price reduction within five (5) days of the effective date.

Failure to report price reductions may result in cancellation of contract for cause, pursuant to provision 5.7(b)1.

In an exceptional situation the State may consider a price adjustment. Requests for price adjustments must include justification and documentation.

6.2 TAX CHARGES

The State of New Jersey is exempt from State sales or use taxes and Federal excise taxes. Therefore, price quotations must not include such taxes. The State's Federal Excise Tax Exemption number is 22-75-0050K.

6.3 PAYMENT TO VENDORS

- a. The using agency(ies) is (are) authorized to order and the contractor is authorized to ship only those items covered by the contract resulting from the RFP. If a review of orders placed by the using agency(ies) reveals that goods and/or services other than that covered by the contract have been ordered and delivered, such delivery shall be a violation of the terms of the contract and may be considered by the Director as a basis to terminate the contract and/or not award the contractor a subsequent contract. The Director may take such steps as are necessary to have the items returned by the agency, regardless of the time between the date of delivery and discovery of the violation. In such event, the contractor shall reimburse the State the full purchase price;
- b. The contractor must submit invoices to the using agency with supporting documentation evidencing that work or goods for which payment is sought has been satisfactorily completed or delivered. For commodity contracts, the invoice, together with the original Bill of Lading, express receipt and other related papers must be sent to the State Contract Manager or using agency on the date of each delivery. For contracts featuring services, invoices must reference the tasks or subtasks detailed in the Scope of Work section of the RFP and must be in strict accordance with the firm, fixed prices submitted for each task or subtask on the RFP pricing sheets. When applicable, invoices should reference the appropriate RFP price sheet line number from the contractor's bid proposal. All invoices must be approved by the State Contract Manager or using agency before payment will be authorized;
- c. In all time and materials contracts, the State Contract Manager or designee shall monitor and approve the hours of work and the work accomplished by contractor and shall document both the work and the approval. Payment shall not be made without such documentation. A form of timekeeping record that should be adapted as appropriate for the Scope of Work being performed can be found at www.nj.gov/treasury/purchase/forms/Vendor_Timesheet.xls; and
- d. The contractor shall provide, on a monthly and cumulative basis, a breakdown in accordance with the budget submitted, of all monies paid to any small business, minority or woman-owned subcontractor(s). This breakdown shall be sent to the Chief of Operations, Division of Revenue, P.O. Box 628, Trenton, NJ 08646.

6.4 OPTIONAL PAYMENT METHOD: P-CARD

The State offers contractors the opportunity to be paid through the MasterCard procurement card (p-card). A contractor's acceptance and a State agency's use of the p-card are optional. P-card transactions do not require the submission of a contractor invoice; purchasing transactions using the p-card will usually result in payment to a contractor in three (3) days. A contractor should take note that there will be a transaction-processing fee for each p-card transaction. To participate, a contractor must be capable of accepting the MasterCard. Additional information can be obtained from banks or merchant service companies.

6.5 NEW JERSEY PROMPT PAYMENT ACT

The New Jersey Prompt Payment Act, N.J.S.A. 52:32-32 et seq., requires state agencies to pay for goods and services within 60 days of the agency's receipt of a properly executed State Payment Voucher or within 60 days of receipt and acceptance of goods and services, whichever is later. Properly executed performance security, when required, must be received by the State prior to processing any payments for goods and services accepted by state agencies. Interest will be paid on delinquent accounts at a rate established by the State Treasurer. Interest shall not be paid until it exceeds \$5.00 per properly executed invoice.

Cash discounts and other payment terms included as part of the original agreement are not affected by the Prompt Payment Act.

6.6 AVAILABILITY OF FUNDS

The State's obligation to make payment under this contract is contingent upon the availability of appropriated funds and receipt of revenues from which payment for contract purposes can be made. No legal liability on the part of the State for payment of any money shall arise unless and until funds are appropriated each fiscal year to the using agency by the State Legislature and made available through receipt of revenue.

7. TERMS RELATING TO ALL CONTRACTS FUNDED, IN WHOLE OR IN PART, BY FEDERAL FUNDS

The provisions set forth in this Section 7 of the Standard Terms and Conditions apply to all contracts funded, in whole or in part, by Federal funds as required by 2 CFR 200.317.

7.1 PROCUREMENT OF RECOVERED MATERIALS

To the extent that the scope of work or specifications in the contract requires the contractor to provide any of the following items, this Section 7.1 of the Standard Terms and Conditions modifies the terms of the scope of work or specification.

Pursuant to 2 CFR 200.322, the contractor must comply with section 6002 of the Solid Waste Disposal Act, as amended by the Resource Conservation and Recovery Act, 42 U.S.C. § 6962. The requirements of Section 6002 include procuring only items designated in guidelines of the Environmental Protection Agency (EPA) at 40 CFR Part 247 that contain the highest percentage of recovered materials practicable, consistent with maintaining a satisfactory level of competition, where the purchase price of the item exceeds \$ 10,000 or the value of the quantity acquired during the preceding fiscal year exceeded \$ 10,000; procuring solid waste management services in a manner that maximizes energy and resource recovery; and establishing an affirmative procurement program for procurement of recovered materials identified in the EPA guidelines.

- A. Designated items are those set forth in 40 CFR 247 subpart B, as may be amended from time to time, including:
 - 1. Paper and paper products listed in 40 C.F.R. 247.10;
 - 2. Certain vehicular products as listed in 40 CFR 247.11;
 - 3. Certain construction products listed in 40 C.F.R. 247.12;
 - 4. Certain transportation products listed in 40 C.F.R. 247.13;
 - 5. Certain park and recreation products, 40 C.F.R. 247.14;
 - 6. Certain landscaping products listed in 40 C.F.R. 247.15;
 - 7. Certain non-paper office products listed in 40 C.F.R. 247.16; and
 - 8. Other miscellaneous products listed in 40 C.F.R. 247.17.

- B. As defined in 40 CFR 247.3, "recovered material" means:
 - 1. waste materials and byproducts which have been recovered or diverted from solid waste, but such term does not include those materials and byproducts generated from, and commonly reused within, an original manufacturing process; and
 - 2. for purposes of purchasing paper and paper products, means waste material and byproducts that have been recovered or diverted from solid waste, but such term does not include those materials and byproducts generated from, and commonly reused within, an original manufacturing process. In the case of paper and paper products, the term recovered materials includes:
 - a. Postconsumer materials such as --
 - i. Paper, paperboard, and fibrous wastes from retail stores, office buildings, homes, and so forth, after they have passed through their end-usage as a consumer item, including: used corrugated boxes; old newspapers; old magazines; mixed waste paper; tabulating cards; and used cordage; and
 - ii. All paper, paperboard, and fibrous wastes that enter and are collected from municipal solid waste, and
 - b. Manufacturing, forest residues, and other wastes such as --

- i. Dry paper and paperboard waste generated after completion of the papermaking process (that is, those manufacturing operations up to and including the cutting and trimming of the paper machine reel in smaller rolls of rough sheets) including: envelope cuttings, bindery trimmings, and other paper and paperboard waste, resulting from printing, cutting, forming, and other converting operations; bag, box, and carton manufacturing wastes; and butt rolls, mill wrappers, and rejected unused stock; and
- ii. Finished paper and paperboard from obsolete inventories of paper and paperboard manufacturers, merchants, wholesalers, dealers, printers, converters, or others;
- iii. Fibrous byproducts of harvesting, manufacturing, extractive, or wood-cutting processes, flax, straw, linters, bagasse, slash, and other forest residues;
- iv. Wastes generated by the conversion of goods made from fibrous material (that is, waste rope from cordage manufacture, textile mill waste, and cuttings); and
- v. Fibers recovered from waste water which otherwise would enter the waste stream.

C. For contracts in an amount greater than \$ 100,000, at the beginning of each contract year, contractor shall provide the State estimates of the total percentage of recovered material utilized in the performance of its contract for each of the categories listed in subsection (A). For all contracts subject to this Section 7.1 of the Standard Terms and Conditions, at the conclusion of each contract year, contractor shall certify to the State the minimum recovered material content actually utilized in the prior contract year.

7.2 EQUAL EMPLOYMENT OPPORTUNITY

Except as otherwise provided under 41 CFR Part 60, all contracts that meet the definition of "federally assisted construction contract" in 41 CFR Part 60-1.3 must include the equal opportunity clause provided under 41 CFR 60-1.4(b), in accordance with Executive Order 11246, "Equal Employment Opportunity" (30 FR 12319, 12935, 3 CFR Part, 1964-1965 Comp., p. 339), as amended by Executive Order 11375, "Amending Executive Order 11246 Relating to Equal Employment Opportunity," and implementing regulations at 41 CFR part 60, "Office of Federal Contract Compliance Programs, Equal Employment Opportunity, Department of Labor."

During the performance of this contract, the contractor agrees as follows:

- (1) The contractor will not discriminate against any employee or applicant for employment because of race, color, religion, sex, sexual orientation, gender identity, or national origin. The contractor will take affirmative action to ensure that applicants are employed, and that employees are treated during employment without regard to their race, color, religion, sex, sexual orientation, gender identity, or national origin. Such action shall include, but not be limited to the following:
 - Employment, upgrading, demotion, or transfer; recruitment or recruitment advertising; layoff or termination; rates of pay or other forms of compensation; and selection for training, including apprenticeship. The contractor agrees to post in conspicuous places, available to employees and applicants for employment, notices to be provided setting forth the provisions of this nondiscrimination clause.
- (2) The contractor will, in all solicitations or advertisements for employees placed by or on behalf of the contractor, state that all qualified applicants will receive consideration for employment without regard to race, color, religion, sex, sexual orientation, gender identity, or national origin.
- (3) The contractor will not discharge or in any other manner discriminate against any employee or applicant for employment because such employee or applicant has inquired about,

discussed, or disclosed the compensation of the employee or applicant or another employee or applicant. This provision shall not apply to instances in which an employee who has access to the compensation information of other employees or applicants as a part of such employee's essential job functions discloses the compensation of such other employees or applicants to individuals who do not otherwise have access to such information, unless such disclosure is in response to a formal complaint or charge, in furtherance of an investigation, proceeding, hearing, or action, including an investigation conducted by the employer, or is consistent with the contractor's legal duty to furnish information.

- (4) The contractor will send to each labor union or representative of workers with which he/she has a collective bargaining agreement or other contract or understanding, a notice to be provided advising the said labor union or workers' representatives of the contractor's commitments under this section, and shall post copies of the notice in conspicuous places available to employees and applicants for employment.
- (5) The contractor will comply with all provisions of Executive Order 11246 of September 24, 1965, and of the rules, regulations, and relevant orders of the Secretary of Labor.
- (6) The contractor will furnish all information and reports required by Executive Order 11246 of September 24, 1965, and by rules, regulations, and orders of the Secretary of Labor, or pursuant thereto, and will permit access to his/her books, records, and accounts by the administering agency and the Secretary of Labor for purposes of investigation to ascertain compliance with such rules, regulations, and orders.
- (7) In the event of the contractor's noncompliance with the nondiscrimination clauses of this contract or with any of the said rules, regulations, or orders, this contract may be canceled, terminated, or suspended in whole or in part and the contractor may be declared ineligible for further Government contracts or federally assisted construction contracts in accordance with procedures authorized in Executive Order 11246 of September 24, 1965, and such other sanctions may be imposed and remedies invoked as provided in Executive Order 11246 of September 24, 1965, or by rule, regulation, or order of the Secretary of Labor, or as otherwise provided by law.
- (8) The contractor will include the portion of the sentence immediately preceding paragraph (1) and the provisions of paragraphs (1) through (8) in every subcontract or purchase order unless exempted by rules, regulations, or orders of the Secretary of Labor issued pursuant to section 204 of Executive Order 11246 of September 24, 1965, so that such provisions will be binding upon each subcontractor or vendor. The contractor will take such action with respect to any subcontract or purchase order as the administering agency may direct as a means of enforcing such provisions, including sanctions for noncompliance:

Provided, however, that in the event a contractor becomes involved in, or is threatened with, litigation with a subcontractor or vendor as a result of such direction by the administering agency, the contractor may request the United States to enter into such litigation to protect the interests of the United States.

The applicant further agrees that it will be bound by the above equal opportunity clause with respect to its own employment practices when it participates in federally assisted construction work: Provided, That if the applicant so participating is a State or local government, the above equal opportunity clause is not applicable to any agency, instrumentality or subdivision of such government which does not participate in work on or under the contract.

The applicant agrees that it will assist and cooperate actively with the administering agency and the Secretary of Labor in obtaining the compliance of contractors and subcontractors with the equal opportunity clause and the rules, regulations, and relevant orders of the Secretary of Labor, that it will furnish the administering agency and the Secretary of Labor such information as they may require for the supervision of such compliance, and that it will otherwise assist the administering agency in the discharge of the agency's primary responsibility for securing compliance.

The applicant further agrees that it will refrain from entering into any contract or contract modification subject to Executive Order 11246 of September 24, 1965, with a contractor debarred from, or who has not demonstrated eligibility for, Government contracts and federally assisted construction contracts pursuant to the Executive Order and will carry out such sanctions and penalties for violation of the equal opportunity clause as may be imposed upon contractors and subcontractors by the administering agency or the Secretary of Labor pursuant to Part II, Subpart D of the Executive Order. In addition, the applicant agrees that if it fails or refuses to comply with these undertakings, the administering agency may take any or all of the following actions: Cancel, terminate, or suspend in whole or in part this grant (contract, loan, insurance, guarantee); refrain from extending any further assistance to the applicant under the program with respect to which the failure or refund occurred until satisfactory assurance of future compliance has been received from such applicant; and refer the case to the Department of Justice for appropriate legal proceedings.

7.3 DAVIS-BACON ACT, 40 U.S.C. 3141-3148, AS AMENDED

When required by Federal program legislation, all prime construction contracts in excess of \$ 2,000 awarded by non-Federal entities must include a provision for compliance with the Davis-Bacon Act (40 U.S.C. 3141-3144, and 3146-3148) as supplemented by Department of Labor regulations (29 CFR Part 5, "Labor Standards Provisions Applicable to Contracts Covering Federally Financed and Assisted Construction"). In accordance with the statute, contractors must be required to pay wages to laborers and mechanics at a rate not less than the prevailing wages specified in a wage determination made by the Secretary of Labor. In addition, contractors must be required to pay wages not less than once a week. The non-Federal entity must place a copy of the current prevailing wage determination issued by the Department of Labor in each solicitation. The decision to award a contract or subcontract must be conditioned upon the acceptance of the wage determination. The non-Federal entity must report all suspected or reported violations to the Federal awarding agency. The contracts must also include a provision for compliance with the Copeland "Anti-Kickback" Act (40 U.S.C. 3145), as supplemented by Department of Labor regulations (29 CFR Part 3, "Contractors and Subcontractors on Public Building or Public Work Financed in Whole or in Part by Loans or Grants from the United States"). The Act provides that each contractor or subrecipient must be prohibited from inducing, by any means, any person employed in the construction, completion, or repair of public work, to give up any part of the compensation to which he or she is otherwise entitled. The non-Federal entity must report all suspected or reported violations to the Federal awarding agency.

7.4 CONTRACT WORK HOURS AND SAFETY STANDARDS ACT, 40 U.S.C. 3701-3708

Where applicable, all contracts awarded by the non-Federal entity in excess of \$ 100,000 that involve the employment of mechanics or laborers must include a provision for compliance with 40 U.S.C. 3702 and 3704, as supplemented by Department of Labor regulations (29 CFR Part 5). Under 40 U.S.C. 3702 of the Act, each contractor must be required to compute the wages of every mechanic and laborer on the basis of a standard work week of 40 hours. Work in excess of the standard work week is permissible provided that the worker is compensated at a rate of not less than one and a half times the basic rate of pay for all hours worked in excess of 40 hours in the work week. The requirements of 40 U.S.C. 3704 are applicable to construction work and provide that no laborer or mechanic must be required to work in surroundings or under working conditions which are unsanitary, hazardous or dangerous. These requirements do not apply to the purchases of supplies or materials or articles ordinarily available on the open market, or contracts for transportation or transmission of intelligence.

7.5 RIGHTS TO INVENTIONS MADE UNDER A CONTRACT OR AGREEMENT

If the Federal award meets the definition of "funding agreement" under 37 CFR § 401.2 (a) and the recipient or subrecipient wishes to enter into a contract with a small business firm or nonprofit organization regarding the substitution of parties, assignment or performance of experimental, developmental, or research work under that "funding agreement," the recipient or subrecipient must comply with the requirements of 37 CFR Part 401, "Rights to Inventions Made by Nonprofit

Organizations and Small Business Firms Under Government Grants, Contracts and Cooperative Agreements," and any implementing regulations issued by the awarding agency.

7.6 CLEAN AIR ACT, 42 U.S.C. 7401-7671Q, AND THE FEDERAL WATER POLLUTION CONTROL ACT, 33 U.S.C. 1251-1387, AS AMENDED

Contracts and subgrants of amounts in excess of \$ 150,000 must contain a provision that requires the non-Federal award to agree to comply with all applicable standards, orders or regulations issued pursuant to the Clean Air Act (42 U.S.C. 7401-7671q) and the Federal Water Pollution Control Act as amended (33 U.S.C. 1251-1387). Violations must be reported to the Federal awarding agency and the Regional Office of the Environmental Protection Agency (EPA).

7.7 DEBARMENT AND SUSPENSION (EXECUTIVE ORDERS 12549 AND 12689)

A contract award (see 2 CFR 180.220) must not be made to parties listed on the government wide exclusions in the System for Award Management (SAM), in accordance with the OMB guidelines at 2 CFR 180 that implement Executive Orders 12549 (3 CFR part 1986 Comp., p. 189) and 12689 (3 CFR part 1989 Comp., p. 235), "Debarment and Suspension." SAM Exclusions contains the names of parties debarred, suspended, or otherwise excluded by agencies, as well as parties declared ineligible under statutory or regulatory authority other than Executive Order 12549.

7.8 BYRD ANTI-LOBBYING AMENDMENT, 31 U.S.C. 1352

Contractors that apply or bid for an award exceeding \$ 100,000 must file the required certification. Each tier certifies to the tier above that it will not and has not used Federal appropriated funds to pay any person or organization for influencing or attempting to influence an officer or employee of any agency, a member of Congress, officer or employee of Congress, or an employee of a member of Congress in connection with obtaining any Federal contract, grant or any other award covered by 31 U.S.C. 1352. Each tier must also disclose any lobbying with non-Federal funds that takes place in connection with obtaining any Federal award. Such disclosures are forwarded from tier to tier up to the non-Federal award.

EXHIBIT A

MANDATORY EQUAL EMPLOYMENT OPPORTUNITY LANGUAGE N.J.S.A. 10:5-31 et seq. (P.L. 1975, c. 127) N.J.A.C. 17:27 et seq.

GOODS, GENERAL SERVICE AND PROFESSIONAL SERVICES CONTRACTS

During the performance of this contract, the contractor agrees as follows:

The contractor or subcontractor, where applicable, will not discriminate against any employee or applicant for employment because of age, race, creed, color, national origin, ancestry, marital status, affectional or sexual orientation, gender identity or expression, disability, nationality or sex. Except with respect to affectional or sexual orientation and gender identity or expression, the contractor will ensure that equal employment opportunity is afforded to such applicants in recruitment and employment, and that employees are treated during employment, without regard to their age, race, creed, color, national origin, ancestry, marital status, affectional or sexual orientation, gender identity or expression, disability, nationality or sex. Such equal employment opportunity shall include, but not be limited to the following: employment, upgrading, demotion, or transfer; recruitment or recruitment advertising; layoff or termination; rates of pay or other forms of compensation; and selection for training, including apprenticeship. The contractor agrees to post in conspicuous places, available to employees and applicants for employment, notices to be provided by the Public Agency Compliance Officer setting forth provisions of this nondiscrimination clause.

The contractor or subcontractor, where applicable will, in all solicitations or advertisements for employees placed by or on behalf of the contractor, state that all qualified applicants will receive consideration for employment without regard to age, race, creed, color, national origin, ancestry, marital status, affectional or sexual orientation, gender identity or expression, disability, nationality or sex.

The contractor or subcontractor will send to each labor union, with which it has a collective bargaining agreement, a notice, to be provided by the agency contracting officer, advising the labor union of the contractor's commitments under this chapter and shall post copies of the notice in conspicuous places available to employees and applicants for employment.

The contractor or subcontractor, where applicable, agrees to comply with any regulations promulgated by the Treasurer pursuant to N.J.S.A. 10:5-31 et seq., as amended and supplemented from time to time and the Americans with Disabilities Act.

The contractor or subcontractor agrees to make good faith efforts to meet targeted county employment goals established in accordance with N.J.A.C. 17:27-5.2.

The contractor or subcontractor agrees to inform in writing its appropriate recruitment agencies including, but not limited to, employment agencies, placement bureaus, colleges, universities, and labor unions, that it does not discriminate on the basis of age, race, creed, color, national origin, ancestry, marital status, affectional or sexual orientation, gender identity or expression, disability, nationality or sex, and that it will discontinue the use of any recruitment agency which engages in direct or indirect discriminatory practices.

The contractor or subcontractor agrees to revise any of its testing procedures, if necessary, to assure that all personnel testing conforms with the principles of job related testing, as established by the statutes and court decisions of the State of New Jersey and as established by applicable Federal law and applicable Federal court decisions.

In conforming with the targeted employment goals, the contractor or subcontractor agrees to review all procedures relating to transfer, upgrading, downgrading and layoff to ensure that all such actions are taken without regard to age, race, creed, color, national origin, ancestry, marital status, affectional or sexual orientation, gender identity or expression, disability, nationality or sex, consistent with the statutes and court decisions of the State of New Jersey, and applicable Federal law and applicable Federal court decisions.

The contractor shall submit to the public agency, after notification of award but prior to execution of a goods and services contract, one of the following three documents:

Letter of Federal Affirmative Action Plan Approval;

Certificate of Employee Information Report; or

Employee Information Report Form AA302 (electronically provided by the Division and distributed to the public agency through the Division's website at http://www.state.nj.us/treasury/contract_compliance).

The contractor and its subcontractors shall furnish such reports or other documents to the Division of Purchase and Property, CCAU, EEO Monitoring Program as may be requested by the office from time to time in order to carry out the purposes of these regulations, and public agencies shall furnish such information as may be requested by the Division of Purchase and Property, CCAU, EEO Monitoring Program for conducting a compliance investigation pursuant to N.J.A.C. 17:27-1 et seq.

EXHIBIT B

MANDATORY EQUAL EMPLOYMENT OPPORTUNITY LANGUAGE

N.J.S.A. 10:5-31 et seq. (P.L. 1975, c. 127)

N.J.S.A. 10:5-39 et seq. (P.L. 1983, c. 197)

N.J.A.C. 17:27-1.1 et seq.

CONSTRUCTION CONTRACTS

During the performance of this contract, the contractor agrees as follows:

The contractor or subcontractor, where applicable, will not discriminate against any employee or applicant for employment because of age, race, creed, color, national origin, ancestry, marital status, affectional or sexual orientation, gender identity or expression, disability, nationality or sex. Except with respect to affectional or sexual orientation and gender identity or expression, the contractor will ensure that equal employment opportunity is afforded to such applicants in recruitment and employment, and that employees are treated during employment, without regard to their age, race, creed, color, national origin, ancestry, marital status, affectional or sexual orientation, gender identity or expression, disability, nationality or sex. Such equal employment opportunity shall include, but not be limited to the following: employment, up grading, demotion, or transfer; recruitment or recruitment advertising; layoff or termination; rates of pay or other forms of compensation; and selection for training, including apprenticeship. The contractor agrees to post in conspicuous places, available to employees and applicants for employment, notices to be provided by the Public Agency Compliance Officer setting forth provisions of this nondiscrimination clause.

The contractor or subcontractor, where applicable will, in all solicitations or advertisements for employees placed by or on behalf of the contractor, state that all qualified applicants will receive consideration for employment without regard to age, race, creed, color, national origin, ancestry, marital status, affectional or sexual orientation, gender identity or expression, disability, nationality or sex.

N.J.S.A. 10:5-39 et seq. requires contractors, subcontractors, and permitted assignees performing construction, alteration, or repair of any building or public work in excess of \$250,000 to guarantee equal employment opportunity to veterans.

The contractor or subcontractor will send to each labor union, with which it has a collective bargaining agreement, a notice, to be provided by the agency contracting officer, advising the labor union or workers' representative of the contractor's commitments under this act and shall post copies of the notice in conspicuous places available to employees and applicants for employment.

The contractor or subcontractor, where applicable, agrees to comply with any regulations promulgated by the Treasurer, pursuant to N.J.S.A. 10:5-31 et seq., as amended and supplemented from time to time and the Americans with Disabilities Act.

When hiring or scheduling workers in each construction trade, the contractor or subcontractor agrees to make good faith efforts to employ minority and women workers in each construction trade consistent with the targeted employment goal prescribed by N.J.A.C. 17:27-7.2; provided, however, that the Dept. of LWD, Construction EEO Monitoring Program may, in its discretion, exempt a contractor or subcontractor from compliance with the good faith procedures prescribed by the following provisions, A, B and C, as long as the Dept. of LWD, Construction EEO Monitoring Program is satisfied that the contractor or subcontractor is employing workers provided by a union which provides evidence, in accordance with standards prescribed by the Dept. of LWD, Construction EEO Monitoring Program, that its percentage of active "card carrying" members who are minority and women workers is equal to or greater than the targeted employment goal established in accordance with N.J.A.C. 17:27-7.2. The contractor or subcontractor agrees that a good faith effort shall include compliance with the following procedures:

(A) If the contractor or subcontractor has a referral agreement or arrangement with a union for a construction trade, the contractor or subcontractor shall, within three business days of the contract award, seek assurances from the union that it will cooperate with the contractor or subcontractor as it fulfills its affirmative action obligations under this contract and in accordance with the rules promulgated by the Treasurer pursuant to N.J.S.A. 10:5-31 et. seq., as supplemented and amended from time to time and the Americans with Disabilities Act. If the contractor or subcontractor is unable to obtain said assurances from the construction trade union at least five business days prior to the commencement of construction work, the contractor or subcontractor agrees to afford equal employment opportunities minority and women workers directly, consistent with this chapter. If the contractor's or subcontractor's prior experience with a construction trade union, regardless of whether the union has provided said assurances, indicates a significant possibility that the trade union will not refer sufficient minority and women workers consistent with affording equal employment opportunities as specified in this chapter, the contractor or subcontractor agrees to be prepared to provide such opportunities to minority and women workers directly, consistent with this chapter, by complying with the hiring or scheduling procedures prescribed under (B) below; and the contractor or subcontractor further agrees to take said action immediately if it determines that the union is not referring minority and women workers consistent with the equal employment opportunity goals set forth in this chapter.

(B) If good faith efforts to meet targeted employment goals have not or cannot be met for each construction trade by adhering to the procedures of (A) above, or if the contractor does not have a referral agreement or arrangement with a union for a construction trade, the contractor or subcontractor agrees to take the following actions:

(1) To notify the public agency compliance officer, the Dept. of LWD, Construction EEO Monitoring Program, and minority and women referral organizations listed by the Division pursuant to N.J.A.C. 17:27-5.3, of its workforce needs, and request referral of minority and women workers;

(2) To notify any minority and women workers who have been listed with it as awaiting available vacancies;

(3) Prior to commencement of work, to request that the local construction trade union refer minority and women workers to fill job openings, provided the contractor or subcontractor has a referral agreement or arrangement with a union for the construction trade;

(4) To leave standing requests for additional referral to minority and women workers with the local construction trade union, provided the contractor or subcontractor has a referral agreement or arrangement with a union for the construction trade, the State Training and Employment Service and other approved referral sources in the area;

(5) If it is necessary to lay off some of the workers in a given trade on the construction site, layoffs shall be conducted in compliance with the equal employment opportunity and non-discrimination standards set forth in this regulation, as well as with applicable Federal and State court decisions;

(6) To adhere to the following procedure when minority and women workers apply or are referred to the contractor or subcontractor:

(i) The contractor or subcontractor shall interview the referred minority or women worker.

(ii) If said individuals have never previously received any document or certification signifying a level of qualification lower than that required in order to perform the work of the construction trade, the contractor or subcontractor shall in good faith

determine the qualifications of such individuals. The contractor or subcontractor shall hire or schedule those individuals who satisfy appropriate qualification standards in conformity with the equal employment opportunity and non-discrimination principles set forth in this chapter. However, a contractor or subcontractor shall determine that the individual at least possesses the requisite skills, and experience recognized by a union, apprentice program or a referral agency, provided the referral agency is acceptable to the Dept. of LWD, Construction EEO Monitoring Program. If necessary, the contractor or subcontractor shall hire or schedule minority and women workers who qualify as trainees pursuant to these rules. All of the requirements, however, are limited by the provisions of (C) below.

(iii) The name of any interested women or minority individual shall be maintained on a waiting list, and shall be considered for employment as described in (i) above, whenever vacancies occur. At the request of the Dept. of LWD, Construction EEO Monitoring Program, the contractor or subcontractor shall provide evidence of its good faith efforts to employ women and minorities from the list to fill vacancies.

(iv) If, for any reason, said contractor or subcontractor determines that a minority individual or a woman is not qualified or if the individual qualifies as an advanced trainee or apprentice, the contractor or subcontractor shall inform the individual in writing of the reasons for the determination, maintain a copy of the determination in its files, and send a copy to the public agency compliance officer and to the Dept. of LWD, Construction EEO Monitoring Program.

(7) To keep a complete and accurate record of all requests made for the referral of workers in any trade covered by the contract, on forms made available by the Dept. of LWD, Construction EEO Monitoring Program and submitted promptly to the Dept. of LWD, Construction EEO Monitoring Program upon request.

(C) The contractor or subcontractor agrees that nothing contained in (B) above shall preclude the contractor or subcontractor from complying with the union hiring hall or apprenticeship policies in any applicable collective bargaining agreement or union hiring hall arrangement, and, where required by custom or agreement, it shall send journeymen and trainees to the union for referral, or to the apprenticeship program for admission, pursuant to such agreement or arrangement. However, where the practices of a union or apprenticeship program will result in the exclusion of minorities and women or the failure to refer minorities and women consistent with the targeted county employment goal, the contractor or subcontractor shall consider for employment persons referred pursuant to (B) above without regard to such agreement or arrangement; provided further, however, that the contractor or subcontractor shall not be required to employ women and minority advanced trainees and trainees in numbers which result in the employment of advanced trainees and trainees as a percentage of the total workforce for the construction trade, which percentage significantly exceeds the apprentice to journey worker ratio specified in the applicable collective bargaining agreement, or in the absence of a collective bargaining agreement, exceeds the ratio established by practice in the area for said construction trade. Also, the contractor or subcontractor agrees that, in implementing the procedures of (B) above, it shall, where applicable, employ minority and women workers residing within the geographical jurisdiction of the union.

After notification of award, but prior to signing a construction contract, the contractor shall submit to the public agency compliance officer and the Dept. of LWD, Construction EEO Monitoring Program an initial project workforce report (Form AA-201) electronically provided to the public agency by the Dept. of LWD, Construction EEO Monitoring Program, through its website, for distribution to and completion by the contractor, in accordance with N.J.A.C. 17:27-7.

The contractor also agrees to submit a copy of the Monthly Project Workforce Report once a month thereafter for the duration of this contract to the Dept. of LWD, Construction EEO Monitoring Program and to the public agency compliance officer.

The contractor agrees to cooperate with the public agency in the payment of budgeted funds, as is necessary, for on the job and/or off the job programs for outreach and training of minorities and women.

- (D) The contractor and its subcontractors shall furnish such reports or other documents to the Dept. of LWD, Construction EEO Monitoring Program as may be requested by the Dept. of LWD, Construction EEO Monitoring Program from time to time in order to carry out the purposes of these regulations, and public agencies shall furnish such information as may be requested by the Dept. of LWD, Construction EEO Monitoring Program for conducting a compliance investigation pursuant to N.J.A.C. 17:27-1.1 et seq.

EXECUTIVE ORDER NO. 161 REQUIREMENTS

It is the policy of the Division of Purchase and Property that its contracts should create a workforce that reflects the diversity of the State of New Jersey. Therefore, contractors engaged by the Division of Purchase and Property to perform under a construction contract shall put forth a good faith effort to engage in recruitment and employment practices that further the goal of fostering equal opportunities to minorities and women.

The contractor must demonstrate to the Division of Purchase and Property's satisfaction that a good faith effort was made to ensure that minorities and women have been afforded equal opportunity to gain employment under the Division of Purchase and Property's contract with the contractor. Payment may be withheld from a contractor's contract for failure to comply with these provisions.

Evidence of a "good faith effort" includes, but is not limited to:

1. The Contractor shall recruit prospective employees through the State Job bank website, managed by the Department of Labor and Workforce Development, available online at <http://NJ.gov/http://NJ.gov/JobCentralNJ>;
2. The Contractor shall keep specific records of its efforts, including records of all individuals interviewed and hired, including the specific numbers of minorities and women;
3. The Contractor shall actively solicit and shall provide the Division of Purchase and Property with proof of solicitations for employment, including but not limited to advertisements in general circulation media, professional service publications and electronic media; and
4. The Contractor shall provide evidence of efforts described at 2 above to the Division of Purchase and Property no less frequently than once every 12 months.
5. The Contractor shall comply with the requirements set forth at N.J.A.C. 17:27.

This language is in addition to and does not replace good faith efforts requirements for construction contracts required by N.J.A.C. 17:27-3.6, 3.7 and 3.8, also known as Exhibit B.

State of New Jersey Standard Terms and Conditions
(Rev: 10/21/19)

**I HEREBY ACCEPT THE TERMS AND CONDITIONS OF
THIS CONTRACT**



Signature

5/28/20

Date

Sean Spooner - Vice President

Print Name and Title

Allstate Office Interiors Inc

Print Name of Contractor

**WAIVERED CONTRACTS SUPPLEMENT TO THE
STATE OF NEW JERSEY STANDARD TERMS AND CONDITIONS
(Rev. 6/14/2018)**

- A. WAIVERED CONTRACTS SUPPLEMENT TO THE STATE OF NEW JERSEY STANDARD TERMS AND CONDITIONS** - This Supplement to the State of New Jersey Standard Terms and Conditions ("Supplement") shall apply to all contracts or purchase agreements made with the State of New Jersey ("State") under N.J.S.A. 52:34-9 or -10 ("Waivered Contracts"). The terms in this Supplement modify the terms of the New Jersey Division of Purchase and Property's Standard Terms and Conditions as may be updated from time to time ("Standard Terms and Conditions"). The combined terms of the Standard Terms and Conditions and this Supplement, in addition to the terms and conditions set forth in the Request for Proposal, Request for Quotation, and/or other agency request ("Solicitation"), if applicable, shall prevail over any conflicts set forth in or incorporated by reference into a contractor's proposal submitted in response to a Solicitation including any standard license, service or other agreement ("Contractor Standard Form Agreement").

The "Contract" shall consist of this Supplement, the Standard Terms and Conditions, the Solicitation, and the proposal submitted by the contractor.

The Standard Terms and Conditions are hereby incorporated by reference. Section numbering of the changes and additions enumerated below continue the number scheme of the Standard Terms and Conditions.

- B. CHANGES/ADDITIONS TO THE STANDARD TERMS AND CONDITIONS FOR ALL GOODS, SERVICES, AND INFORMATION TECHNOLOGY WAIVERED CONTRACTS:**

2.13 OWNERSHIP DISCLOSURE

Pursuant to N.J.S.A. 52:25-24.2, in the event the contractor is a corporation, partnership or limited liability company, the contractor must complete an Ownership Disclosure Form.

A current completed Ownership Disclosure Form must be received prior to or accompany the submitted proposal. A contractor's failure to submit the completed and signed form with its proposal will result in the rejection of the proposal as non-responsive and preclude the award of a Contract to said contractor unless the Division has on file a signed and accurate Ownership Disclosure Form dated and received no more than six (6) months prior to the receipt of the proposal. If any ownership change has occurred within the last six (6) months, a new Ownership Disclosure Form must be completed, signed and submitted with the proposal.

In the alternative, to comply with this section, a contractor with any direct or indirect parent entity which is publicly traded may submit the name and address of each publicly traded entity and the name and address of each person that holds a 10 percent or greater beneficial interest in the publicly traded entity as of the last annual filing with the federal Securities and Exchange Commission or the foreign equivalent, and, if there is any person that holds a 10 percent or greater beneficial interest, also shall submit links to the websites containing the last annual filings with the federal Securities and Exchange Commission or the foreign equivalent and the relevant page numbers of the filings that contain the information on each person that holds a 10 percent or greater beneficial interest. N.J.S.A. 52:25-24.2.

2.14 PROHIBITED INVESTMENT IN IRAN

Pursuant to N.J.S.A. 52:32-58, the contractor must utilize this Disclosure of Investment Activities in Iran form to certify that neither the contractor, nor one (1) of its parents, subsidiaries, and/or affiliates (as defined in N.J.S.A. 52:32-56(e)(3)), is listed on the Department of the Treasury's List of Persons or Entities Engaging in Prohibited Investment Activities in Iran and that neither the contractor, nor one (1) of its parents, subsidiaries, and/or affiliates, is involved in any of the investment activities set forth in N.J.S.A. 52:32-56(f). If the contractor is unable to so certify, the contractor shall provide a detailed and precise description of such activities as directed on the form.

**WAIVERED CONTRACTS SUPPLEMENT TO THE
STATE OF NEW JERSEY STANDARD TERMS AND CONDITIONS
(Rev. 6/14/2018)**

2.15 STATE'S RIGHT TO INSPECT CONTRACTOR'S FACILITIES

The State reserves the right to inspect the contractor's establishment before making an award, for the purposes of ascertaining whether the contractor has the necessary facilities for performing the Contract.

The State may also consult with clients of the contractor to assist the State in making a contract award that is most advantageous to the State.

2.16 STATE'S RIGHT TO REQUEST FURTHER INFORMATION

The Director reserves the right to request all information which may assist him or her in making a contract award, including factors necessary to evaluate the contractor's financial capabilities to perform the Contract. Further, the Director reserves the right to request a contractor to explain, in detail, how the proposal price was determined.

2.17 DELIVERY TIME AND COSTS

Unless otherwise noted elsewhere in the Solicitation, all delivery times are 30 calendar days after receipt of order (ARO) and prices for items in proposals shall be submitted Freight On Board (F.O.B.) Destination (30 calendar days ARO/F.O.B.). The contractor shall assume all costs, liability and responsibility for the delivery of merchandise in good condition to the State's Using Agency or designated purchaser. Thirty calendar days ARO/F.O.B. does not cover "spotting" but does include delivery on the receiving platform of the Using Agency at any destination in the State of New Jersey unless otherwise specified.

No additional charges will be allowed for any additional transportation costs resulting from partial shipments made at the contractor's convenience when a single shipment is ordered.

The weights and measures of the State's Using Agency receiving the shipment shall govern.

2.18 COLLECT ON DELIVERY (C.O.D) TERMS

C.O.D. terms will not be accepted.

2.19 CASH DISCOUNTS

The contractor is encouraged to offer cash discounts based on expedited payment by the State. The State will make efforts to take advantage of discounts.

Should the contractor choose to offer cash discounts the following shall apply:

- A. Discount periods shall be calculated starting from the next business day after the Using Agency has accepted the goods or services, received a properly signed and executed invoice and, when required, a properly executed performance security, whichever is latest; and
- B. The date on the check issued by the State in payment of that invoice shall be deemed the date of the State's response to that invoice.

2.20 CLAIMS AND REMEDIES

- A. All claims asserted against the State by the contractor shall be subject to the New Jersey Tort Claims Act, N.J.S.A. 59:1-1, et seq., and/or the New Jersey Contractual Liability Act, N.J.S.A. 59:13-1, et seq.

**WAIVERED CONTRACTS SUPPLEMENT TO THE
STATE OF NEW JERSEY STANDARD TERMS AND CONDITIONS
(Rev. 6/14/2018)**

- B. Nothing in this Contract shall be construed to be a waiver by the State of any warranty, expressed or implied, of any remedy at law or equity, except as specifically and expressly stated in a writing executed by the Director.
- C. In the event that the contractor fails to comply with any material Contract requirements, the Director may take steps to terminate this Contract in accordance with the Standard Terms and Conditions, authorize the delivery of contract items by any available means, with the difference between the price paid and the defaulting contractor's price either being deducted from any monies due the defaulting contractor or being an obligation owed the State by the defaulting contractor, as provided for in the State administrative code, or take any other action or seek any other remedies available at law or in equity.

2.21 NEWS RELEASES & ADVERTISING

- A. The contractor is not permitted to issue news releases pertaining to any aspect of the services being provided under this Contract without the prior written consent of the Director.
- B. The contractor shall not use the State's name, logos, images, or any data or results arising from this Contract as a part of any commercial advertising without first obtaining the prior written consent of the Director.

2.22 ORGAN DONATION

As required by N.J.S.A. 52:32-33.1, the State encourages the contractor to disseminate information relative to organ donation and to notify its employees, through information and materials or through an organ and tissue awareness program, of organ donation options. The information provided to employees should be prepared in collaboration with the organ procurement organizations designated pursuant to 42 U.S.C. 1320b-8 to serve in this State.

3.8 PERFORMANCE SECURITY

If performance security is required, such security must be submitted with the bid in the amount listed in the Solicitation. N.J.A.C. 17:12-2.5. Acceptable forms of performance security are as follows:

1. A properly executed individual or annual performance bond issued by an insurance or security company authorized to do business in the State of New Jersey,
2. A certified or cashier's check drawn to the order of "Treasurer, State of New Jersey," or
3. An irrevocable letter of credit issued by a federally insured financial institution and naming "Treasurer, State of New Jersey," as beneficiary.

The Performance Security must be submitted to the State within 30 days of the effective date of the Contract award and cover the period of the Contract and any extensions thereof. Failure to submit performance security may result in cancellation of the Contract for cause and nonpayment for work performed.

Although the performance bond is required for the full term of the Contract, the Director recognizes that the industry practice of sureties is to issue a one (1) year performance bond for goods and services contracts. Thus, the contractor is permitted to submit a one (1) year performance bond for the amount required under the Contract and, on each succeeding anniversary date of the Contract, provide a continuation or renewal certificate to evidence that the bond is in effect for the next year of the Contract. This procedure will remain in place for each year of the Contract thereafter until the termination of the Contract. Failure to provide such proof on the anniversary date of the Contract shall result in suspension of the Contract, and possibly, termination of the Contract.

**WAIVERED CONTRACTS SUPPLEMENT TO THE
STATE OF NEW JERSEY STANDARD TERMS AND CONDITIONS
(Rev. 6/14/2018)**

For performance bonds based on a percentage of the total estimated Contract price. On each anniversary of the effective date of the Contract, the amount of the required performance bond, unless otherwise noted, is calculated by applying the established RFQ performance bond percentage to the outstanding balance of the estimated amount of the Contract price to be paid to the contractor.

In the event that the Contract price is increased by a Contract Amendment, the contractor may be required to provide, within 30 calendar days of the effective date of the Contract Amendment, performance bond coverage for the increase in Contract price. The required increase in the performance bond amount is calculated by applying the established bond percentage set forth above to the increase in Contract price. Failure to provide such proof to the Director of this required coverage may result in the suspension of payment to the contractor until such time the contractor complies with this requirement.

3.9 RETAINAGE

If retainage is required on the Contract as stated in the Solicitation, the state and/or agency will retain the stated percentage or retainage from each invoice. Payment of retainage will be authorized after satisfactory completion and submission of all services, deliverables or work products by the contractor and acceptance by the agency of all services, deliverables or work products required by the Contract.

For ongoing contracts, the agency will retain the stated percentage of each invoice submitted. At the end of the three (3) month period after payment of each invoice, the agency will review the contractor's performance and if performance has been satisfactory, the agency will release the retainage for the preceding three (3) month period. Following the expiration of the Contract, retained fees will be released to the contractor after certification by the agency's project manager, if any, that all services have been satisfactorily performed.

3.10 SUBCONTRACTOR UTILIZATION PLAN

A contractor that will subcontract any of the work or services to be provided under the Contract shall submit to the agency along with its proposal a Subcontractor Utilization Plan located at the following webpage: <http://www.state.nj.us/treasury/purchase/forms/subcontracting.pdf>. See also Section 5.8 of the Standard Terms and Conditions.

5.17 CONFIDENTIALITY

- a. The State's obligation to maintain the confidentiality of the contractor's confidential information provided to the State under the Contract is conditioned upon and subject to the State's obligations under the New Jersey Public Records Act, N.J.S.A. 47:1A-1 et seq., ("OPRA"), the New Jersey common law right to know, and any other lawful document request or subpoena.
- b. By virtue of the Contract, the parties may have access to information that is confidential to one another. The parties agree to disclose only information that is required for the performance of their obligations under the Contract. The contractor's confidential information, to the extent not expressly prohibited by law, shall consist of all information clearly identified as confidential at the time of disclosure ("Contractor Confidential Information"). Notwithstanding the previous sentence, the contractor acknowledges the terms and pricing of the Contract are subject to disclosure under OPRA, the New Jersey common law right to know, and any other lawful document request or subpoena.
- c. The State's Confidential Information shall consist of all information or data in any form whatsoever supplied by the State, any information or data gathered by the contractor in fulfillment of the Contract and any analysis thereof (whether in fulfillment of the Contract or not).
- d. A party's Confidential Information shall not include information that: (a) is or becomes a part of the public domain through no act or omission of the other party, except that if the information is personally identifying to a person or entity regardless of whether it has become part of the public

**WAIVERED CONTRACTS SUPPLEMENT TO THE
STATE OF NEW JERSEY STANDARD TERMS AND CONDITIONS
(Rev. 6/14/2018)**

domain through other means, the other party must maintain full efforts under the Contract to keep it confidential; (b) was in the other party's lawful possession prior to the disclosure and had not been obtained by the other party either directly or indirectly from the disclosing party; (c) is lawfully disclosed to the other party by a third party without restriction on the disclosure; or (d) is independently developed by the other party.

- e. The parties agree to hold each other's Confidential Information in confidence, using at least the same degree of care in doing so that it uses to protect its own confidential information.
- f. In the event that the State receives a request for Contractor Confidential Information related to the Contract pursuant to a court order, subpoena, lawful document request or other operation of law, the State agrees, if permitted by law, to provide the contractor with as much notice, in writing, as is reasonably practicable and the State's intended response to such request. The contractor shall take any action it deems appropriate to protect its documents and/or information.
- g. In addition, in the event the contractor receives a request for State Confidential Information pursuant to a court order, subpoena, or other operation of law, the contractor shall, if permitted by law, provide the State with as much notice, in writing, as is reasonably practicable and the contractor's intended response to such request. The State shall take any action it deems appropriate to protect its documents and/or information. Notice to the State shall not relieve the contractor of its obligation to take action to protect such information if the contractor is aware of a legal reason to do so.
- h. Notwithstanding the requirements of nondisclosure described in this Section 5.17, either party may release the other party's Confidential Information (i) if directed to do so by a court or arbitrator of competent jurisdiction, (ii) pursuant to a lawfully issued subpoena or other lawful document request, (iii) in the case of the State, if the State determines the documents or information are subject to disclosure and the contractor does not exercise its rights as described in subsection (f), or if the contractor is unsuccessful in defending its rights as described in subsection (f), or (iv) in the case of the contractor, if the contractor determines the documents or information are subject to disclosure and the State does not exercise its rights as described in subsection (g), or if the State is unsuccessful in defending its rights as described in subsection (g).

C. CHANGES/ADDITIONS TO THE STANDARD TERMS AND CONDITIONS APPLICABLE TO SERVICES AND INFORMATION TECHNOLOGY WAIVERED CONTRACTS:

4.2 INSURANCE

The following paragraph D is added to section 4.2 of the Standard Terms and Conditions:

- D. Professional Liability Insurance: When it is common to the contractor's profession to do so, the contractor shall carry Errors and Omissions, Professional Liability Insurance and/or Professional Liability Malpractice Insurance sufficient to protect the contractor from any liability arising out the professional obligations performed pursuant to the requirements of the Contract. The insurance shall be in the amount of not less than \$5,000,000 and in such policy forms as shall be approved by the State. If the contractor has claims-made coverage and subsequently changes carriers during the term of the Contract, it shall obtain from its new Errors and Omissions, Professional Liability Insurance and/or Professional Malpractice Insurance carrier an endorsement for retroactive coverage.

5.18 OWNERSHIP

Capitalized terms used but not defined are defined in Subsection D of this Supplement, below.

- a. Contractor Intellectual Property; COTS and Customized Software – The contractor retains ownership of all Contractor Intellectual Property, and any modifications thereto and derivatives thereof, that the contractor supplies to the State pursuant to the Contract. The contractor grants the State a non-exclusive, perpetual royalty-free license to use Contractor Intellectual Property delivered to the State for the purposes contemplated by the Contract.

**WAIVERED CONTRACTS SUPPLEMENT TO THE
STATE OF NEW JERSEY STANDARD TERMS AND CONDITIONS
(Rev. 6/14/2018)**

- b. **Third Party Intellectual Property** – Unless otherwise specified in the Solicitation that the State, on its own, will acquire and obtain a license to Third Party Intellectual Property, the contractor shall secure on the State's behalf, in the name of the State and subject to the State's approval, a license to Third Party Intellectual Property sufficient to fulfill the business objectives, requirements and specifications identified in the Contract at no additional cost to the State beyond that in the bid price. Under no circumstances will the State accept a license for Third Party Intellectual Property that contains terms and conditions that conflict with the terms and conditions of the Contract. If the contractor uses Third Party Intellectual Property, the contractor must indemnify the State for infringement claims with respect to the Third Party Intellectual Property. The contractor agrees that its use of Third Party Intellectual Property shall be consistent with the license for the Third Party Intellectual Property, whether supplied by the contractor, secured by the State as required by the Solicitation, or otherwise supplied by the State.
- c. **Work Product; Custom Software** – The State owns all Custom Software which shall be considered "work made for hire", i.e., the State, not the contractor, subcontractor, or third party, shall have full and complete ownership of all such Custom Software. To the extent that any Custom Software may not, by operation of the law, be a "work made for hire" in accordance with the terms of the Contract, contractor, subcontractor, or third party hereby assigns to the State, or the contractor shall cause to be assigned to the State, all right, title and interest in and to any such Custom Software and any copyright thereof, and the State shall have the right to obtain and hold in its own name any copyrights, registrations and any other proprietary rights that may be available.
- d. **Work Product; Services** – The State owns all Deliverables developed for the State in the course of providing Services under the Contract, including but not limited to, all data, technical information, materials gathered, originated, developed, prepared, used or obtained in the performance of the Contract, including but not limited to all reports, surveys, plans, charts, literature, brochures, mailings, recordings (video and/or audio), pictures, drawings, analyses, graphic representations, print-outs, notes and memoranda, written procedures and documents, regardless of the state of completion, which are prepared for or are a result of the Services required under the Contract.
- e. **State Intellectual Property – Data and Background Information.** The State owns all State Intellectual Property and State data and background information provided to the contractor pursuant to the Contract. The State's data and background information shall include, without limitation, all data, technical information, and materials provided to the contractor by the State to facilitate performance of the Contract, including but not limited to all reports, plans, charts, literature, brochures, mailings, recordings (video and/or audio), pictures, drawings, analyses, graphic representations, software computer programs and accompanying documentation and print-outs, notes and memoranda, written procedures and documents. The items described in the preceding sentence shall be delivered or returned to the State of New Jersey upon thirty (30) days' notice by the State or thirty (30) days after the expiration or termination of the Contract. Only to fulfill the purposes of the Contract does the State grant the contractor a non-exclusive, royalty-free, worldwide license to use, copy, display, distribute, transmit and prepare derivative works of State Intellectual Property and State data and background information. Notwithstanding anything to the contrary contained in the Terms and Conditions or this Supplement, no part of the State's data will be disclosed, sold, assigned, leased or otherwise disposed of to any person or entity other than the State unless specifically directed to do so in writing by the Contract Manager. The State's license to the contractor is limited by the term of the Contract and the confidentiality obligations set forth in Section 5.17 of this Supplement.
- f. **No Rights** – Except as expressly set forth in the Contract, nothing in the Contract shall be construed as granting to or conferring upon the contractor any right, title, or interest in State Intellectual Property or any intellectual property that is now owned or licensed to or subsequently owned by or licensed by the State. Except as expressly set forth in the Contract, nothing in the Contract shall be construed as granting to or conferring upon the State any right, title, or interest in any Contractor Intellectual Property that is now owned or subsequently owned by the contractor. Except as expressly set forth in the Contract, nothing in the Contract shall be construed as granting to or conferring upon the State any right, title, or interest in any Third Party Intellectual Property that is now owned or subsequently owned by a Third Party.

**WAIVERED CONTRACTS SUPPLEMENT TO THE
STATE OF NEW JERSEY STANDARD TERMS AND CONDITIONS
(Rev. 6/14/2018)**

D. CHANGES/ADDITIONS TO THE STANDARD TERMS AND CONDITIONS FOR ALL INFORMATION TECHNOLOGY WAIVERED CONTRACTS:

1.2 DEFINITIONS

The following definitions shall apply to information technology contracts:

- i. The term "Acceptance" means the written confirmation by an Agency that the contractor has completed a Deliverable according to the specified requirements.
- ii. The term "Contractor Intellectual Property" means any intellectual property that is owned by the contractor and contained in or necessary for the use of the Deliverables or which the contractor makes available for the State to use as part of the work under the Contract. Contractor Intellectual Property includes COTS or Customized Software owned by the contractor, the contractor's technical documentation, and derivative works and compilations of any Contractor Intellectual Property.
- iii. The term Commercial Off the Shelf Software ("COTS") means Software provided by the contractor that is intended for general use.
- iv. The term "Custom Software" means Software and Work Product that is developed by the contractor at the request of the Agency to meet the specific requirements of the Agency and is intended for its use.
- v. The term "Customized Software" means COTS that is adapted by the contractor to meet specific requirements of the Agency that differ from the standard requirements of the base product.
- vi. The term "Deliverable" means the goods, products, Services and Work Product that the contractor is required to deliver to the State under the Contract;
- vii. The terms "goods" and "products" shall be deemed to include, without limitation, Software and Hardware.
- viii. The term "Hardware" shall be deemed to include computer equipment and any Software provided with the Hardware that is necessary for the Hardware to operate.
- ix. The term "Information Technology Contract" shall mean, notwithstanding any definition in New Jersey Statutes, a Contract for one or more of the following: Hardware, Software, Services, telecommunication goods and services, and all related goods.
- x. The terms "Services" shall be deemed to include, without limitation (i) Information Technology ("IT") professional services; (ii) Software and Hardware-related services, including without limitation, installation, configuration, and training and (iii) Software and Hardware maintenance and support and/or Software and Hardware technical support services.
- xi. The term "Software" means, without limitation, computer programs, source codes, routines, or subroutines supplied by the contractor, including operating software, programming aids, application programs, application programming interfaces and software products, and includes COTS, Customized Software and Custom Software, unless the context indicates otherwise.
- xii. The term "State Intellectual Property" means any intellectual property that is owned by the State. State Intellectual Property includes any derivative works and compilations of any State Intellectual Property.
- xiii. The term "Third Party Intellectual Property" means any intellectual property owned by parties other than the State or the contractor and contained in or necessary for the use of the Deliverables. Third Party Intellectual Property includes COTS owned by Third Parties, and derivative works and compilations of any Third Party Intellectual Property.
- xiv. The term "Work Product" means every invention, modification, discovery, design, development, customization, configuration, improvement, process, Software program, work of authorship, documentation, formula, datum, technique, know how, secret, or intellectual property right whatsoever or any interest therein (whether patentable or not patentable or registerable under copyright or similar statutes or subject to analogous protection) that is specifically made, conceived, discovered, or reduced to practice by the contractor or the contractor's subcontractors or a third party engaged by the contractor or its subcontractor pursuant to the Contract. Notwithstanding anything to the contrary in the preceding sentence, Work Product does not include State Intellectual Property, Contractor Intellectual Property or Third Party Intellectual Property.

**WAIVERED CONTRACTS SUPPLEMENT TO THE
STATE OF NEW JERSEY STANDARD TERMS AND CONDITIONS
(Rev. 6/14/2018)**

2.10 COMPLIANCE - LAWS

The following is added to section 2.10 of the Standard Terms and Conditions:

COMPLIANCE – DATA AND PRIVACY LAWS – The contractor must comply with all State and Federal data and privacy laws, rules and regulations applicable to both the contractor and the State under the Contract.

4.1 INDEMNIFICATION

Section 4.1 of the Standard Terms and Conditions is deleted in its entirety and replaced with the following:

INDEMNIFICATION AND LIMITATION OF LIABILITY:

1. **INDEMNIFICATION** - The contractor's liability to the State and its employees in third party suits shall be as follows:
 - a) The contractor shall assume all risk of and responsibility for, and agrees to indemnify, defend, and save harmless the State and its officers, agents, servants and employees, from and against any and all third party claims, demands, suits, actions, recoveries, judgments and costs and expenses in connection therewith:
 - i. For or on account of the loss of life, property or injury or damage to the person, body or property of any person or persons whatsoever, which shall arise from or result directly or indirectly from the work and/or products supplied under the Contract or the order; and
 - ii. For or on account of the use of any patent, copyright, trademark, trade secret or other proprietary right of any copyrighted or uncopyrighted composition, secret process, patented or unpatented invention, article or appliance ("Intellectual Property Rights") furnished or used in the performance of the Contract; and
 - iii. The contractor's indemnification and liability under subsection (a) is not limited by, but is in addition to the insurance obligations contained in these Standard Terms and Conditions.
 - b) In the event of a claim or suit involving third-party Intellectual Property Rights, the contractor, at its option, may: (1) procure for the State the legal right to continue the use of the product; (2) replace or modify the product to provide a non-infringing product that is the functional equivalent; or (3) refund the purchase price less a reasonable allowance for use that is agreed to by both parties. The State will (1) promptly notify the contractor in writing of the claim or suit; (2) the contractor shall have control of the defense and settlement of any claim that is subject to subsection (a); provided, however, that the State must approve any settlement of the alleged claim, which approval shall not be unreasonably withheld. The State may observe the proceedings relating to the alleged claim and confer with the contractor at its expense. Furthermore, neither the contractor nor any attorney engaged by the contractor shall defend the claim in the name of the State of New Jersey or any Agency, nor purport to act as legal representative of the State of New Jersey or any Agency, without having provided notice to the Director of the Division of Law in the Department of Law and Public Safety and to the Director of DPP. The State of New Jersey may, at its election and expense, assume its own defense and settlement.
 - c) Notwithstanding the foregoing, the contractor has no obligation or liability for any claim or suit concerning third-party Intellectual Property Rights arising from: (1) the State's unauthorized combination, operation, or use of a product supplied under the Contract with any product, device, or Software not supplied by the contractor; (2) the State's unauthorized alteration or modification of any product supplied under the Contract; (3) the contractor's compliance with the State's designs, specifications, requests, or instructions, provided that if the State provides the contractor with such designs, specifications, requests, or instructions, the contractor reviews same and advises that such designs, specifications, requests or instructions present potential issues of patent or copyright infringement and the State nonetheless directs the contractor to proceed with one or more designs, specifications, requests or instructions that

**WAIVERED CONTRACTS SUPPLEMENT TO THE
STATE OF NEW JERSEY STANDARD TERMS AND CONDITIONS
(Rev. 6/14/2018)**

present potential issues of patent or copyright infringement; or (4) the State's failure to promptly implement a required update or modification to the product provided by the contractor.

- d) The contractor will be relieved of its responsibilities under subsection (a)(i) and (ii) for any claims made by an unaffiliated third party that arise solely from the actions or omissions of the State, its officers, employees or agents.
- e) This section states the entire obligation of the contractor and its suppliers, and the exclusive remedy of the State, in respect of any infringement or alleged infringement of any Intellectual Property Rights. This indemnity obligation and remedy are given to the State solely for its benefit and in lieu of, and the contractor disclaims, all warranties, conditions and other terms of non-infringement or title with respect to any product.
- f) The provisions of this indemnification clause shall in no way limit the contractor's obligations assumed in the Contract, nor shall they be construed to relieve the contractor from any liability, nor preclude the State from taking any other actions available to it under any other provisions of the Contract or otherwise at law or equity.
- g) The contractor agrees that any approval by the State or Using Agency of the work performed and/or reports, plans or specifications provided by the contractor shall not operate to limit the obligations of the contractor assumed in the Contract.
- h) The State of New Jersey will not indemnify, defend or hold harmless the contractor. The State will not pay or reimburse for claims absent compliance with Section 4.1(2) of this Supplement and a determination by the State to pay the claim or a final order of a court of competent jurisdiction.

2. STATE RESPONSIBILITIES

Subject to the New Jersey Tort Claims Act (N.J.S.A. 59:1-1 et seq.), the New Jersey Contractual Liability Act (N.J.S.A. 59:13-1 et seq.) and the appropriation and availability of funds, the State will be responsible for any cost or damage arising out of actions or inactions of the State, its employees or agents under Section 4.1(1)(a)(i) and (ii) of this Supplement which results in an unaffiliated third party claim. This is the contractor's exclusive remedy for these claims.

3. LIMITATION OF LIABILITY

- a) The contractor's liability to the State for actual, direct damages resulting from the contractor's performance or non-performance of, or in any manner related to, the Contract for any and all claims, shall be limited in the aggregate to 200% of the fees paid to the contractor for the products or Services giving rise to such damages, except that such limitation of liability shall not apply to the following:
 - i. The contractor's indemnification obligations as described in Section 4.1(1) of this Supplement; and
 - ii. The contractor's breach of its obligations of confidentiality described in Section 5.17 of this Supplement; and
- b) The contractor shall not be liable for consequential or incidental damages.

5.11 CONTRACTOR PERFORMANCE WARRANTIES

Section 5.11 of the Standard Terms and Conditions is deleted in its entirety and replaced with the following:

1. COTS and Customized Software

- a. Unless the Contractor Standard Form Agreement provides greater coverage as determined by the State, in its sole discretion, the contractor warrants that COTS and Customized Software products licensed to the State shall operate in all material respects as described in the Solicitation and/or contractor technical documentation for ninety (90) days after Acceptance. The State shall

**WAIVERED CONTRACTS SUPPLEMENT TO THE
STATE OF NEW JERSEY STANDARD TERMS AND CONDITIONS
(Rev. 6/14/2018)**

notify the contractor of any COTS or Customized Software product deficiency within ninety (90) days after Acceptance. For a Contract requiring the delivery of COTS or Customized Software and Custom Software, a notice within one hundred eighty (180) days that describes a deficiency in functional terms without specifying whether the deficiency is with COTS, Customized Software or Custom Software shall be deemed a notice that triggers the warranty provisions in both Section 5.11(a) and 5.11(b) of this Supplement.

- b. Except for the portion of the contractor's COTS or Customized Software product that intentionally contains one or more of the following for the purpose of anti-virus protection, the contractor warrants that, at the time of delivery and installation of the COTS or Customized Software provided pursuant to the Contract, its product shall be free of what are commonly defined as viruses, backdoors, worms, spyware, malware and other malicious code that will hamper performance of the COTS or Customized Software, collect unlawful personally identifiable information on users, or prevent the COTS or Customized Software from performing as required under the Contract.
- c. In the event of any breach of this warranty, the contractor shall correct the product errors that caused the breach of warranty, or if the contractor cannot substantially correct such breach in a commercially reasonable manner, the State may end its usage and recover the fees paid to the contractor for the license and any unused, prepaid, technical support fees paid. Under no circumstances does this warranty provision limit the contractor's obligation in the event of a breach of confidentiality.
- d. The contractor does not warrant that COTS or Customized Software is error-free or that it will operate uninterrupted.

2. Custom Software

- a. Unless the Contractor Standard Form Agreement provides greater coverage, as determined by the State, in its sole discretion, the contractor warrants that Custom Software Deliverables shall operate in all material respects as described in the applicable specification documentation for one hundred and eighty (180) days after Acceptance. The State shall notify the contractor of any Custom Software deficiency within one hundred and eighty (180) days after Acceptance of the Custom Software Deliverable (the "Notice Period"). Where the contractor is providing multiple Custom Software Deliverables over the term of the Contract, the Notice Period shall begin to run after the Acceptance of the final Custom Software Deliverable under the Contract. At that time, the State may assert defect claims relating to any and all of the Custom Software Deliverables provided under the Contract; however, the State may also assert claims earlier, in its discretion, without waiving the Notice Period.
- b. For a Contract requiring the delivery of COTS or Customized Software and Custom Software, a notice within one hundred eighty (180) days that describes a deficiency in functional terms without specifying whether the deficiency is with COTS, Customized Software or Custom Software shall be deemed a notice that triggers the warranty provisions in both Section 5.11(a) and 5.11(b) of this Supplement.
- c. The contractor warrants that, at the time of Acceptance of the Custom Software Deliverable provided pursuant to the Contract, its product shall be free of what are commonly defined as viruses, backdoors, worms, spyware, malware and other malicious code that will hamper performance of the Custom Software, collect unlawful personally identifiable information on users, or prevent the Custom Software from performing as required under the Contract. Under no circumstances does this warranty provision limit the contractor's obligation in the event of a breach of confidentiality.
- d. In the event of any breach of this warranty, the contractor shall correct the Custom Software errors that caused the breach of warranty, or if the contractor cannot substantially correct such breach in a commercially reasonable manner, the State may recover a portion of the fees paid to the contractor for the Custom Software with the uncorrected defect or in the event that the Custom Software is still deemed, by the State in its sole discretion, to be usable by the State even with the uncorrected defect, the State may recover a portion of the fees paid to the

**WAIVERED CONTRACTS SUPPLEMENT TO THE
STATE OF NEW JERSEY STANDARD TERMS AND CONDITIONS
(Rev. 6/14/2018)**

contractor for the Custom Software (up to the total amount of such charges for such Custom Software) to reflect any reduction in the value of the Custom Software Deliverable as a result of the uncorrected defect. Under no circumstances does this warranty provision limit the contractor's obligations in the event of a breach of confidentiality.

- e. The contractor does not warrant that Custom Software is error-free or that it will operate uninterrupted.

3. IT Services

- a. Unless the Contractor Standard Form Agreement provides greater coverage, as determined by the State, in its sole discretion, the contractor warrants that all Services will be provided in a professional manner consistent with industry standards. The State shall notify the contractor of any Services warranty deficiencies within ninety (90) days from performance of the deficient Services.
- b. In the event of any breach of this warranty, the contractor shall re-perform the deficient Services, or if the contractor cannot substantially correct a breach in a commercially reasonable manner, the State may end the relevant Services and recover the fees paid to the contractor for the deficient Services.

4. Hardware

- a. Unless the Contractor Standard Form Agreement provides greater coverage, as determined by the State, in its sole discretion, the contractor warrants that the equipment offered is standard new equipment, and is the manufacturer's latest model in production, with parts regularly used for the type of equipment offered; that such parts are all in production and not likely to be discontinued; and that no attachment or part has been substituted or applied contrary to manufacturer's recommendations and standard practice.
- b. The contractor warrants that all equipment supplied to the State and operated by electrical current is UL listed where applicable.
- c. The contractor warrants that all new machines are to be guaranteed as fully operational for one (1) year from time of Acceptance by the State. For the avoidance of doubt, Acceptance with respect to Hardware in this subsection (d) shall occur no later than sixty (60) days after delivery, as evidenced by a signed delivery receipt. The contractor shall render prompt service without charge, regardless of geographic location.
- d. The contractor warrants that sufficient quantities of parts necessary for proper service to equipment shall be maintained at distribution points and service headquarters.
- e. The contractor warrants that trained mechanics are regularly employed to make necessary repairs to equipment in the territory from which the service request might emanate within a 48-hour period or within the time accepted as industry practice.
- f. The contractor warrants that all Software included with the Hardware shall perform substantially in accordance with specifications, for one (1) year from the time of Acceptance. The contractor warrants that Software media will be free from material defects in materials and workmanship for a period of one (1) year from the date of Acceptance.
- g. In the event of any breach of this warranty, the contractor shall promptly repair, replace or refund the purchase price of product rejected for failure to conform with the contractor's product specifications.

- 5. THE WARRANTIES SET FORTH HEREIN ARE EXCLUSIVE AND IN LIEU OF ALL OTHER WARRANTIES, WHETHER EXPRESS OR IMPLIED, AND THE CONTRACTOR EXPRESSLY DISCLAIMS ALL OTHER WARRANTIES, INCLUDING ANY IMPLIED WARRANTIES OF MERCHANTABILITY, OR FITNESS FOR A PARTICULAR PURPOSE.

**WAIVERED CONTRACTS SUPPLEMENT TO THE
STATE OF NEW JERSEY STANDARD TERMS AND CONDITIONS
(Rev. 6/14/2018)**

5.19 AUDIT NOTICE AND DISPUTE RESOLUTION

To the extent the contractor's proposal or Standard Form Agreement permits the contractor to conduct periodic audits of the State's usage of the Contractor Intellectual Property provided thereunder, such provision is amended to include the following audit notice and dispute resolution process:

- a. **AUDIT NOTICE** – Notwithstanding anything to the contrary in the contractor's proposal or Standard Form Agreement, in the event that the contractor seeks to exercise a right in its proposal or Standard Form Agreement to audit the State's use of Contractor Intellectual Property, the contractor shall deliver simultaneous written notice, no less than thirty days in advance of the audit start date (unless the contractor's notice provides a longer notice period), to the:
 - i. Director of the New Jersey Department of Treasury, Division of Purchase and Property:
Procurement Bureau, Technology Unit
P.O. Box 230
Trenton, NJ 08625-0230
 - ii. Chief of Staff of the New Jersey Office of Information Technology:
Office of the Chief Technology Officer
300 Riverview Plaza
Trenton, NJ 08625
 - iii. State Contract Manager.

The notice shall reference the specific audit provision(s) in the contractor's proposal or Standard Form Agreement being exercised and include copies of same, specify the means by which the contractor will conduct the audit, and shall require the audit to be conducted in accordance with generally accepted standards in the field of such audits.

- b. **AUDIT DISPUTE RESOLUTION** – If the State, in good faith, provides the contractor with written notice of an alleged error in the amount of underpaid fees due the contractor as a result of an audit (the "dispute"), then the parties will endeavor to resolve the dispute in accordance with this paragraph. Each party will appoint a Vice President, Assistant Director, or the equivalent (hereinafter referred to as "Representative") to discuss the dispute and no formal proceedings for the judicial resolution of such dispute, except for the seeking of equitable relief or those required to avoid non-compliance with the New Jersey Contractual Liability Act, N.J.S.A. 59:13-1 et seq., may begin until either such Representative concludes, after a good faith effort to resolve the dispute, that resolution through continued discussion is unlikely. In addition, the parties shall refrain from exercising any termination right related to the dispute being considered under this paragraph and shall continue to perform their respective obligations under the Contract while they endeavor to resolve the dispute under this paragraph.
- c. **STATE NOT LIABLE FOR AUDIT COSTS** -- Notwithstanding anything to the contrary in the contractor's proposal or Standard Form Agreement, the State will not reimburse the contractor for any costs related to an audit.
- d. **NO AUDIT RIGHT CREATED** – In the event that the contractor's proposal or Standard Form Agreement does not permit audits of the State's usage of Contractor Intellectual Property, Section 5.19 of this Supplement shall not be interpreted to provide such an audit right.

**WAIVERED CONTRACTS SUPPLEMENT TO THE
STATE OF NEW JERSEY STANDARD TERMS AND CONDITIONS
(Rev. 6/14/2018)**

**I HEREBY ACCEPT THE TERMS AND CONDITIONS
OF THIS CONTRACT**



Signature

5/29/20

Date

Sean Spooner - Vice President

Print Name and Title

Allstate Office Interiors Inc

Print Name of Contractor