

# Enhancing Multi-jurisdictional Use and Management of Water Resources for the Delaware River Basin, NY, NJ, PA, and DE December 2008



Prepared by:



**USACE**  
**Philadelphia District**



**TABLE OF CONTENTS**  
**Multi-jurisdictional Use and Management of Water Resources for the Delaware**  
**River Basin, NY, PA, NJ and DE**

**TABLE OF CONTENTS**

EXECUTIVE SUMMARY.....		10-13
1.0 INTRODUCTION		
1.1 Study Purpose .....		14
1.2 Study Authority.....		14
1.3 Stakeholder Involvement.....		14-15
1.4 Study Proposal.....		15-16
1.5 Managing Water Resources in the Basin.....		16-17
1.6 Evolution of Objectives.....		18
1.7 Study Area .....		19-20
2.0 LONG TERM SUFFICIENCY OF WATER SUPPLY THROUGH 2030.....		21-22
2.1 Water Availability Analysis.....		22
2.1.1 Basin Delineation.....		22-30
2.1.2 Ground Water Availability.....		31-36
2.1.3 Surface Water Availability.....		37-40
2.1.4 Affects of Climate Variability.....		41-42
2.2 Water Demand.....		43
2.2.1 Existing Conditions.....		43
2.2.2 Forecasting Future Demand .....		43-45
2.2.2.1 Methodology Used For Watershed Analysis .....		45
2.2.2.1.1 Population Growth.....		45-47
2.2.2.1.2 Water Conservation.....		48
2.2.3 Results of Water Demand Forecasting and Availability Analysis		49-54
2.2.4 Sensitivity Analysis.....		55
2.2.5 Summary of Total Withdrawals and Consumptive Use by Watershed		55-57
2.2.6 River Analysis for Surface Water Withdrawals.....		58-59
2.3 Calculating Water Supply Deficits.....		60
2.3.1 Water Supply Deficits in Watersheds Identified for Further Study		60-66
2.3.2 Calculating Water Deficiencies for the Delaware, Schuylkill and Lehigh Rivers		67-69
2.3.2.1 Deficiencies in the Year 2003 .....		70-78
2.3.2.2 Deficiencies in the Year 2030.....		79-85
2.3.2.3 Deficiencies Under Drought Conditions.....		86-94
2.4 Potential Alternatives for Water Supply.....		95
2.4.1 Expand Supply Alternatives .....		95
2.4.1.1 Aquifer Storage and Recovery .....		95

	2.4.1.2 Expansion of Municipal Systems . . . . .	95
	2.4.1.3 Reuse of Waste and Storm Water . . . . .	95
	2.4.1.4 Mine Reclamation . . . . .	96
	2.4.1.5 Desalination . . . . .	96
	2.4.1.6 Delaware River Diversion . . . . .	96-97
	2.4.1.7 Reservoir Storage in the Delaware River Basin . . . . .	98-104
	2.4.1.8 Reservoir Storage in the Schuylkill River Basin . . . . .	105
	2.4.1.8.1 Maiden Creek . . . . .	106-107
	2.4.1.8.2 French Creek . . . . .	108
	2.4.1.8.3 Evansburg . . . . .	108-111
	2.4.2 Curtail Demand Alternatives . . . . .	112
	2.4.2.1 Improved Water Accountability with Reduced Infrastructure . . . . .	112-114
	2.4.2.2. Additional Conservation. . . . .	114
	2.4.2.3 Change Water Allocations/New Regulations. . . . .	115
	2.4.2.4 Improved Irrigation Techniques. . . . .	115
	2.5 Conclusions and Recommendations . . . . .	115-116
3.0	FLOOD RISK MANAGEMENT.. . . .	117-118
	3.1 Discharge Frequency Analysis . . . . .	118-125
	3.2 Skew Analysis . . . . .	126-129
	3.3 Identification of Priority Communities . . . . .	129-136
	3.4 Structure Inventory for 10 Priority Communities . . . . .	137-140
	3.5 Solution Matrix for 10 Priority Communities . . . . .	140-153
	3.6 Flood Risk Management Recommendations . . . . .	154
	3.6.1 Flood Warning/Forecasting Tool for Delaware River Basin. .154	
	3.6.2 Flood Risk Management Feasibility Studies for Priority Communities. . . . .	154
	3.6.3 Detailed Feasibility Studies for Additional Flood Prone Communities. . . . .	154
4.0	ESTUARY INFLOW EVALUATION . . . . .	155
5.0	RE-EVALUATE APPROACH TO USER SUPPLY COSTS TO SUPPORT FLOW MANAGEMENT AND EQUITABLE ALLOCATION GOALS. . . . .	156
	5.1 Financing Water Supply Storage. . . . .	156
	5.2 Determining Water Supply Costs through 2030. . . . .	156
	5.2.1 Estimated Annual Operation, Maintenance and Administrative Costs 156-157	
	5.2.2 Estimated Major Repair/Upgrade Costs. . . . .	158-160
	5.2.3 Projected Costs t Meet Increased Demand. . . . .	160-162
	5.3 Debt Repayment . . . . .	162
	5.4 Alternative Charge Schedules . . . . .	162
	5.5 Determining Need to update Surface Water Rates for Basin Users . . . . .	162
6.0	GEOGRAPHIC INFORMATION SYSTEM (GIS) PUBLIC ACCESS TO INFORMATION. . . . .	164
7.0	CONTINUATION OF EFFORTS . . . . .	164-165

Appendix A	Water Supply
Appendix B	Flood Risk Management
Appendix C	Estuary Inflow Evaluation
Appendix D	User Supply Fees

## LIST OF TABLES

Table 2.1	Summary of Watershed Scale Characteristics. . . . .	25
Table 2.2	Basin Identification . . . . .	27-30
Table 2.3	Ground-Water Availability. . . . .	33-36
Table 2.4	Major Reservoirs in the Delaware River Basin. . . . .	40
Table 2.5	Summary of Data Requirements and Key Water Demand Drivers for Each Water Use Sector. . . . .	46-47
Table 2.6	Water Conservation Assumptions by Sector. . . . .	49
Table 2.7	Current and Future Water use, Aggregated to the Watershed Scale (Annual MGD) . . . . .	56
Table 2.8	Current and Future Water use, Aggregated to the Watershed Scale (Peak MGD)/July. . . . .	57
Table 2.9	Withdrawals at Identified Surface Water Deficient Basins . . . . .	63
Table 2.10	Withdrawals at Identified Ground Water Deficient Basins. . . . .	63
Table 2.11	Combined SW and GW Deficits at Various %Reductions in Supply . . .	64
Table 2.12	Delaware River Year 2003 Water Supply Conditions. . . . .	71-72
Table 2.13	Schuylkill River Year 2003 Water Supply Conditions . . . . .	73
Table 2.14	Lehigh River Year 2003 Water Supply Conditions. . . . .	74
Table 2.15	Delaware River Year 2030 Projected Water Supply Conditions . . . . .	80-81
Table 2.16	Schuylkill River Year 2030 Projected Water Supply Conditions. . . . .	82
Table 2.17	Lehigh River Year 2030 Water Supply Conditions. . . . .	83
Table 2.18	Delaware River Q710 with Reductions. . . . .	87
Table 2.19	Schuylkill River Q710 with Reductions. . . . .	88
Table 2.20	Lehigh River Q710 with Reductions. . . . .	88
Table 2.21	Water Supply Conditions on the Delaware River when Q710 Reduced by 50%. . . . .	89-90
Table 2.22	Water Supply Conditions on the Schuylkill River when Q710 Reduced by 50%. . . . .	91
Table 2.23	Water Supply Conditions on the Lehigh River when Q710 Reduced by 50%. . . . .	92
Table 2.24	Delaware River Water Supply Conditions in 2030 with Priority Watersheds Incorporated. . . . .	99-101
Table 2.25	Reductions in Available Water for Delaware River with Priority Watersheds Incorporated . . . . .	102-104
Table 2.26	Reservoir Yields. . . . .	109
Table 2.27	50% Reduction in Available Water for Schuylkill River with Potential Reservoir Projects Incorporated. . . . .	110-111
Table 2.28	Range of Potential Savings from Addressing Water Loss Issues Within PWS. . . . .	114
Table 3.1	Updated Delaware River Gaging Stations . . . . .	119
Table 3.2	Reservoirs Simulation in Rainfall-Runoff Models. . . . .	121
Table 3.3	Adopted Discharge Frequency Values for Delaware River . . . . .	123
Table 3.4	Comparison of Adopted Flood Frequency Against 1984 Flood Frequency	

Table 3.5	Peak Discharge from Historical and Record Flood Events on the Delaware River.....	125
Table 3.6	Repetitive Loss Rankings By Basin.....	131
Table 3.7	Severely Repetitive Loss Rankings By Basin.....	132
Table 3.8	Repetitive & Severe Repetitive Loss Claims.....	135
Table 3.9	Summary of Structure Inventory.....	137
Table 3.10	Sample Depth Damage Curves.....	139
Table 3.11	Descriptions of Possible Alternatives.....	141-144
Table 3.12	Solution Matrix for Top 10 Priority Communities.....	145-153
Table 5.1	Estimated Annual Operations and Maintenance Joint Use Costs.....	157
Table 5.2	Estimated Major Repairs/Upgrades for Beltzville Lake.....	159
Table 5.3	Estimated Major Repairs/Upgrades for Blue Marsh Lake.....	160

## LIST OF FIGURES

Figure 2.1	HUC 8 Watersheds. . . . .	23
Figure 2.2	HUC 11 Watersheds. . . . .	23
Figure 2.3	HUC 14 Watersheds. . . . .	23
Figure 2.4	Basin Plan Sub-basins. . . . .	23
Figure 2.5	Flow Management Sub-basins. . . . .	24
Figure 2.6	USGS Ground-Water Availability Sub-basins. . . . .	24
Figure 2.7	Delineation of Sub-basins. . . . .	26
Figure 2.8	Ground Water Protected Area in Southeastern PA and NJ Water Supply Critical Area 2. . . . .	32
Figure 2.9	Surface Water Availability at Index Stations. . . . .	39
Figure 2.10	Water Withdrawals in the Delaware River basin 2003. . . . .	43
Figure 2.11	Anticipated Change in Peak Month Water Demand for 2003-2030 Excluding Water Conservation . . . . .	50
Figure 2.12	Anticipated Change in Peak Month Water Demand for 2003-2030 Including Water Conservation . . . . .	50
Figure 2.13	Projected Trends in Peak Month Water Withdrawals, by Sector 2003-2030	52
Figure 2.14	Projected Trends in Peak Month Water Withdrawals (excluding Thermoelectric), by Sector 2003-2030 . . . . .	52
Figure 2.15	Ground Water Availability for 2003. . . . .	53
Figure 2.16	Ground Water Availability for 2030. . . . .	53
Figure 2.17	Surface Water Availability for 2003 . . . . .	54
Figure 2.18	Surface Water Availability for 2030 . . . . .	54
Figure 2.19	Peak Month Surface Water Availability for the Delaware, Lehigh and Schuylkill Rivers (2003) . . . . .	59
Figure 2.20	Peak Month Surface Water Availability for the Delaware, Lehigh and Schuylkill Rivers (2003) . . . . .	59
Figure 2.21	Priority Watershed within the Delaware River Basin. . . . .	62
Figure 2.22	Deficits in Surface Water 7Q10 in the year 2003 and 2030 in the Critical Surface Water New Jersey Basins . . . . .	64
Figure 2.23	Deficits in Surface Water 7Q10 in the year 2003 and 2030 in the Critical Surface Water Pennsylvania Basins . . . . .	65
Figure 2.24	Deficits in Surface Water 7Q10 in the year 2003 and 2030 in the Critical Surface Water New Jersey Basins . . . . .	65
Figure 2.25	Deficits in Ground Water 7Q10 in the year 2003 and 2030 in the Critical Ground Water Delaware Basins . . . . .	66
Figure 2.26	Deficits in Surface and Ground Water at Various Reduction Percentages in Supply for the Critical New Jersey Basins . . . . .	66
Figure 2.27	Deficits in Ground Water at Various Reduction Percentages in Supply for the Critical Delaware Basins . . . . .	67
Figure 2.28	Location of Withdrawal Points on Delaware, Schuylkill, and Lehigh Rivers . . . . .	69
Figure 2.29	Schuylkill River Reaches. . . . .	75
Figure 2.30	Delaware River Reaches. . . . .	76
Figure 2.31	Delaware River Year 2003 Water Supply Conditions . . . . .	77

Figure 2.32	Schuylkill River year 2003 Water Supply Conditions. . . . .	78
Figure 2.33	Delaware River Year 2030 Water Supply Conditions. . . . .	84
Figure 2.34	Schuylkill River year 2030 Water Supply Conditions. . . . .	85
Figure 2.35	Water Supply Conditions on the Delaware River when Q710 Reduced by 50% . . . . .	93
Figure 2.36	Water Supply Conditions on the Schuylkill River when Q710 Reduced by 50%. . . . .	94
Figure 2.37	Delaware River Diversions Utilized in Analysis . . . . .	97
Figure 2.38	Location of Projects. . . . .	107
Figure 2.39	AWWA Water Accountability Water Audit Structure. . . . .	113
Figure 3.1	Lambertville-New Hope Bridge. . . . .	117
Figure 3.2	Lambertville. . . . .	117
Figure 3.3	Highest Repetitive Loss Rankings By Basin. . . . .	133
Figure 3.4	Highest Severe Repetitive Loss Rankings By Basin. . . . .	134
Figure 3.5	Key Flood Prone Areas Used For Structure Inventories and Solution Matrix. . . . .	136
Figure 3.6	Aerial Photograph . . . . .	138



## LIST OF ACRONYMS

ASR	Aquifer Storage and Recovery
AWWA	American Water Works Association
COMM	Commercial
DNREC	Department of Natural Resources and Environmental Control
DRBC	Delaware River Basin Commission
DYNHYD5	Dynamic Estuary Model Hydrodynamics Program
FAC	Flood Advisory Committee
FEMA	Federal Emergency Management Agency
GIS	Geographic Information System
GWPA	Ground Water Protected Area
HEC	Hydrologic Engineering Center
HUC	Hydrologic Unit Code
KRA	Key Result Area
Mg/D	Million Gallons per Day
NECIA	The Northeast Climate Impacts Assessment
NGO	non-Governmental Organization
NJDEP	New Jersey Department of Environmental Protection
NRCS	Natural Resources Conservation Service
NWS	National Weather Service
OASIS	Operational Analysis & Simulation of Integrated Systems
PADEP	Pennsylvania Department of Environmental Protection
PWD	Philadelphia Water Department
PWR	Power
PWS	Public Water Sector
QA/QC	Quality Assurance/Quality Control
SPF	Standard Project Flood
TOXIC5	Chloride Transport Model
USGS	U. S. Geological Survey
WMAC	Water Management Advisory Committee
WQAC	Water Quality Advisory Committee
WSCC	Water Supply Coordination Council

## **EXECUTIVE SUMMARY**

In FY06, the Energy and Water Development Appropriations Act (PL 109-103) was passed, directing the Secretary to conduct, “at full federal expense, comprehensive analyses that examine multi-jurisdictional use and management of water resources on a watershed or regional scale.” In response to this Act, the Philadelphia District submitted a proposal for a potential project in the Delaware River Basin entitled “Multi-jurisdictional Use and Management of Water Resources for the Delaware River Basin, NY, NJ, PA and DE” which would primarily address flood risk management and water supply issues. This study was one of five selected nationwide and was funded in the amount of \$1,105,000.

The five goals of this study include Long Term Sufficiency of Water Supply through the year 2030, Flood Risk Management, Estuary Inflow, Re-evaluation of User Supply Costs to Support Flow Management and Equitable Allocation Goals, and GIS/Public Outreach. These five tasks will be defined further in the report.

The major stakeholders in this project were the Delaware River Basin Commission (DRBC), U.S. Geological Service (USGS), Federal Emergency Management Office (FEMA), New Jersey Department of Environmental Protection (NJDEP), National Weather Service (NWS) and the Corps’ Hydrologic Engineering Center (HEC). In the true spirit of collaboration, many of these agencies provided not only their expertise to the project but also provided much of their own funding.

### **TASK 1: LONG TERM SUFFICIENCY OF WATER SUPPLY**

Task 1 is aimed at addressing long-term supply and demand through the year 2030. Once water supply and demand projections were calculated and water conservation plans were evaluated, areas of critical need were identified, and potential alternatives were assessed for the three major rivers; the Delaware, Schuylkill and Lehigh.

The results of the basin wide water supply-demand evaluation identified several priority watersheds where the supply-demand balance indicated possible water supply problems. In total, eight watersheds have been identified, all of which are located in the lower half of the Basin.

The results of the river analysis showed the Delaware River had one power-sector withdrawal point being identified as deficient in the vicinity of Trenton, NJ, while the Schuylkill River increased from one to three withdrawal point deficiencies and the Lehigh River had no deficient withdrawal points through the year 2030.

## **Potential Alternatives for Water Supply Deficits**

Several alternatives were examined that could potentially meet the surface and groundwater deficiencies previously identified at the high priority watersheds and along the Schuylkill and Delaware Rivers. These alternatives include the diversion of water from the Delaware River and reservoir storage in the Schuylkill River Basin to include the Maiden Creek, French Creek and Evansburg Reservoirs and modification to Blue Marsh. It is recommended that all of these alternatives and others not mentioned be examined in detail in a comprehensive Basin-wide water supply “feasibility-level” study.

### **TASK 2: FLOOD RISK MANAGEMENT**

This study looked at several different aspects of flood risk management, including updating flood frequency curves, conducting a skew analysis, and identifying priority sites for which a solution matrix and structure inventory were completed. These priority sites include the towns of Yardley, New Hope, Upper Makefield and Easton, PA; Lambertville, Harmony, Stockton and Belvidere, NJ; as well as Rockland and Colchester, NY.

### **TASK 3: ESTUARY INFLOW EVALUATION**

In order to consider a flow management plan for salinity intrusion, this study linked three existing water resources computer models: the Operational Analysis and Simulation of Integrated Systems (OASIS flow model) one-dimensional reservoir operating model, The Dynamic Estuary Model Hydrodynamics Program (DYNHYD5) hydrodynamic model and the TOXI5 chloride transport model (the latter two are collectively referred to as “the estuary salinity model”). Linking these models will enable engineers to better predict the effects of reservoir operating program alternatives on salinity concentrations within the estuary and thus will enhance the ability of the DRBC staff to furnish the commissioners with the technical support they require to make informed flow management policy decisions; and in particular, this project is needed for the DRBC staff to provide the Commission with the support that it has recently requested for the development of flood mitigation operating plans for existing reservoirs.

### **TASK 4: RE-EVALUATION OF USER SUPPLY COSTS TO SUPPORT FLOW MANAGEMENT AND EQUITABLE ALLOCATION GOALS**

While the DRBC does not own or operate any of the dams within the Basin, it has purchased a portion of the storage in two Corps of Engineers reservoirs. This storage is financed through a surface water charging program with rates which have not changed since their inception.

Due to ever changing demands in water supply and the potential need for additional storage, this study took the opportunity to review projected costs for water supply and alternate rate calculation methods in order to meet these costs. Based on information gathered in this report it does not appear necessary to update surface water rates to basin

users. However, additional water supply needs should be re-evaluated under a thorough drought analysis and may thereby require an update to this evaluation.

## **TASK 5: GEOGRAPHIC INFORMATION SYSTEM (GIS)/PUBLIC ACCESS TO INFORMATION**

One of the most important aspects of this study is to ensure that the work conducted here does not become “just another study” but continues beyond this study in aiding other Federal, state, and local agencies in their work. The public access component of this study provides an opportunity to share data gathered for this study with local communities/state and Federal agencies for on-going and future study efforts. It’s the team’s hope that this study will demonstrate the importance of data sharing and unified data collection.

### **STUDY RECOMMENDATIONS AND ROAD AHEAD**

Although this report does not make recommendations for future construction projects, it does make recommendations for future studies. Below is a summary of potential future efforts which should be evaluated further.

#### **1. Detailed Drought Analysis**

A comprehensive drought analysis, that incorporates the drought of record along with possible synthetic droughts that could be worse than the drought of the record, should be conducted and an examination of FE Walter Modification should be done in this comprehensive basin-wide drought analysis.

#### **2. Drought sensitivity analysis of 137 watersheds not evaluated under this study**

The analysis was restricted to the ten watersheds identified as being deficient using projections out to the year 2030, and only examined reducing water availability in those ten identified watersheds in the lower portion of the Basin. It would be reasonable to expect that by reducing  $Q_{710}$  and the 25-yr baseflow by 25%, 50%, and 75% in the other 137 watersheds that additional deficits in the Basin would have to be addressed, and that FE Walter Modification could be a possible solution to meet those deficits.

#### **3. Comprehensive Basin-wide water supply “feasibility-level” study.**

A comprehensive basin-wide “feasibility-level” study should be conducted to evaluate alternatives that expand supply or curtail demand. Alternatives that expand supply include such things as: aquifer storage and recovery (ASR), expansion of municipal systems, reuse of waste and storm water, mine reclamation, desalination, river diversions, and reservoir storage. Alternatives that curtail demand include: improved water accountability with reduced infrastructure losses, additional conservation, change water allocations, new regulations, and improved irrigation techniques.

#### **4. French Creek, Maiden Creek, Evansburg and Blue Marsh Modification**

These three reservoirs in combination with modification to the existing Blue Marsh Reservoir should be considered for water supply flow augmentation for the drought sensitivity analysis.

## **5. Flood warning/forecasting tool for entire Delaware River Basin**

Flood Inundation Mapping similar to that being developed for the Delaware River Basin Comprehensive, Watershed Flood Management Plan should be developed for the entire mainstem Delaware to be used as a planning and emergency management tool.

Using the depth grid and underlying base data, determination of extent and depth of flooding as it impacts buildings and transportation systems and expected damages to structures and contents could be made readily available through the GIS.

## **6. Detailed feasibility studies for priority communities in Pennsylvania and New York**

Detailed studies should be conducted for the priority communities located in Pennsylvania and New York (Delaware River Basin Comprehensive, NJ is already reviewing New Jersey sites). These sites should be re-evaluated using multi-purpose projects (environmental restoration/flood damage reduction) rather than the traditional single purpose projects that many were originally evaluated under. Projects with negative Federal interest should still be evaluated by locals and other means of sponsorship should be pursued.

## **1.0 INTRODUCTION**

### **1.1 STUDY PURPOSE**

The Multi-jurisdictional Use and Management of Water Resources for the Delaware River Basin, NY, PA, NJ and DE study was conducted as a complimentary report to the Delaware River Basin Commissions (DRBC)'s Water Resources Plan for the Delaware River Basin, a long-range goal-based plan developed with the collaboration of New York, New Jersey, Delaware, and Pennsylvania through the DRBC.

This study is aimed at advancing critical initiatives of the Basin Plan relating to (1) establishing sustainable water use and supply, (2) helping prioritize near and long term investment needs for storage and flood risk management projects, (3) supporting a collective problem-solving initiative now underway that will revise reservoir release regimes to better serve human and ecological needs and (4) preparing a preliminary report on flood vulnerability and management capacity in the wake of some of the worst flooding the Basin has seen in the past fifty years.

### **1.2 STUDY AUTHORITY**

In FY06, the Energy and Water Development Appropriations Act (PL 109-103) was passed, directing the Secretary to conduct, "at full federal expense, comprehensive analyses that examine multi-jurisdictional use and management of water resources on a watershed or regional scale". In response to this Act, the Philadelphia District submitted a proposal for a potential project in the Delaware River Basin entitled "Multi-jurisdictional Use and Management of Water Resources for the Delaware River Basin, NY, NJ, PA and DE" which would primarily address flood risk management and water supply issues. This study was one of five selected nationwide and was funded in the amount of \$1,105,000.

### **1.3 STAKEHOLDER INVOLVEMENT**

The primary stakeholder in this project was the DRBC and its Commissioners, which are comprised of the Governors and their representatives from the four Basin States (New York, New Jersey, Pennsylvania and Delaware) and a Federal Representative which is the Commander of the Army Corps of Engineers' North Atlantic Division.

The DRBC was involved in every aspect of this project from problem identification though the development of potential alternatives. As one of the lead water resource agencies in the Basin, the DRBC assisted in the collaboration with state, local and other Federal Agencies in order to coordinate ongoing efforts.

It was through DRBC's Watershed Advisory Committee, Flood Advisory Committee and other such committees that the team was able to discuss on-going issues and study findings with members of academia, private industry, all levels of government and private citizens. And it's due to DRBC's 40+ years of experience as a key partner in numerous

water related projects within the Basin that they proved to be an invaluable partner in this process.

Other major stakeholders involved in this study include the U.S Geological Service (USGS), Federal Emergency Management Office (FEMA), New Jersey Department of Environmental Protection (DEP) National Weather Service, (NWS) and the Corps' Hydrologic Engineering Center (HEC). And in the true spirit of collaboration, each of these agencies provided not only their expertise to the project but also provided much of their own funding.

A few examples of these collaborative efforts include: conducting a discharge-frequency analysis, reviewing repetitive loss claims, and updating a regional skew analysis.

The discharge-frequency analysis involved work from the USGS, FEMA, NJDEP, NWS and DRBC, all of which worked closely with the Philadelphia District's Hydraulic & Hydrologic Branch to conduct a discharge-frequency analysis on eight gaging stations on the Delaware River in order to update the analysis conducted in the Delaware River Basin Study Report dated 1984.

FEMA assisted with the repetitive loss claims which were used in further refining the study area for certain tasks, including the development of a solution matrix and the structure inventory, while the Corps' Hydrologic Engineering Center conducted a regional skew analysis, again to update the 1984 Basin Study.

#### **1.4 STUDY PROPOSAL**

The initial proposal sent to the Secretary's office described the study purpose as a collaborative effort with stakeholders to advance efforts of the Delaware River Basin Commission's Water Resources Plan or "Basin Plan" in order to achieve integrated water resources management.

In an effort to accomplish this goal the proposal consisted of three interdependent initiatives: (1) long term sufficiency of water in the Delaware River Basin, (2) long-term flow management, and (3) provision of timely and easily accessible information to the public. Below is a brief description of each of these tasks.

Task 1: Long term sufficiency of water: This study was to involve recently completed groundwater availability analyses, demand projections and decree parties' plans for storage upgrades, and long term flow management strategies for the Delaware River. This initiative incorporated an analysis of existing reservoir storage and proposed supply enhancement projects as well as identification of supply enhancement needs to protect water delivery obligations, ensure drought preparedness, and meet evolving conditions.

Task 2: Effective, long-term flow management: This task had three major subtasks; (1) estuary inflow evaluation, (2) multi-jurisdictional flood risk management and (3) re-evaluation of DRBC's approach to Water Supply User Costs. The estuary inflow evaluation consisted of linking a one-dimensional hydrodynamic/salinity model in the

estuary with the Operational Analysis and Simulation of Integrated Systems (OASIS) flow model. The Flood Risk Management Plan involved a flood vulnerability analysis and management capabilities based on review of existing state and Federal data from past disasters, repetitive loss claims and flow regime information and finally, subtask three was to re-evaluate the current rule which allocates costs to users on a pro rata basis as a function of DRBC's Salinity Repulsion policy. Alternative approaches would potentially result in different cost allocations and revenues.

Task 3: Provision of timely and easily accessible information to the public: This task involved the distribution of both data collected and generated for this study to local communities and other agencies to assist in ongoing and future studies and reduce the potential for duplication of effort.

In order to better understand the importance of these tasks it is critical to understand DRBC's role in managing water resources for the Basin and how all of the study's tasks relate to the overarching Basin Plan.

## **1.5 MANAGING WATER RESOURCES IN THE BASIN**

The Delaware River Basin Commission which was founded in 1961, partly out of concern for water allocations and out-of-basin transfers in the New York portion of the basin, is an interstate-federal agency responsible for managing the water resources in the 13,539 square-mile Delaware River watershed. The DRBC is a unique institutional framework consisting of the Governors of the four Basin States (New York, New Jersey, Pennsylvania and Delaware) and a presidential appointee, which is the Commander of the North Atlantic Division, USACE. The Commander represents not only USACE's interests, but those of all Federal agencies within the Basin.

In 1962, the newly formed DRBC instituted a Comprehensive Plan, initially based on the plan developed by USACE (House Document 522) for the immediate and long-range development and use of the water resources of the Basin. The Comprehensive Plan includes a dozen multi-purpose reservoir projects, including Tocks Island, a large impoundment planned for the Delaware River main stem.

The DRBC's Comprehensive Plan has been continuously maintained since the Commission was established in 1961. This includes the addition, change or deletion of components to reflect changing needs of a dynamic region and its people. This maintenance requires the delicate balance of many very complex technical, institutional, and political interests and concerns.

The Comprehensive Plan actually consists of a body of documents expressing a systematic set of policies and programs for the future, and the means for carrying them out. This includes statements of policy, criteria, and standards as well as all public and private projects and facilities that are required for the optimum planning, development, conservation, use, management, and control of the Basin's water resources. These include impoundments and regulatory measures ranging from various physical features of land management in the uppermost headwater areas, through small detention reservoirs in the



intermediate upstream areas, to major impounding reservoirs in the principal water course areas. These policies, programs and projects are expressed through narrative text, maps, charts, schedules, budgets, and other means.

The Comprehensive Plan is dynamic, being periodically revised. The Plan continues to grow in scope as the Commission regularly adds new policies, criteria, standards, and projects. The Comprehensive Plan, therefore, goes beyond a presentation of programs and plans and includes administrative decisions governing water resources use, development, and conservation. From time to time specific projects, facilities and programs are incorporated, deleted, or modified to reflect changing conditions, research results, and new technology. The DRBC receives and considers proposals for changes and additions to the Comprehensive Plan from all interested persons, organizations, and groups. Projects are reviewed with the main purposes of determining whether the project will have a substantial effect on the water resources of the Basin; or substantially impair or conflict with the Comprehensive Plan.

One of the purposes of the Multi-jurisdictional Use and Management study is to provide water resource management alternatives that may be used to update the DRBC Comprehensive Plan. The study can be used to evolve the Comprehensive Plan in the areas of water supply and flood mitigation. Facilities or programs in these areas resulting from the study may be incorporated in the Comprehensive Plan to provide long term management of Water Resources.

In addition to the Comprehensive Plan, in 1999, the DRBC was tasked with the development of a Water Resources Plan. Together the Governors of the four Basin States, along with USACE, EPA Region II and Region III, and the National Park Service signed a resolution challenging the Basin community to develop a unifying vision; a comprehensive Water Resources Plan for the Delaware River Basin. The Water Resources Plan for the Delaware River Basin or the “Basin Plan” was a long-range goal-based plan developed by DRBC through a multi-party collaborative process. The four Basin States, along with the Corps and other interested federal and state agencies, local governments, academia, private industry and other major stakeholders participated in the plan’s development and pledged to support the implementation.

The purpose of this study was to identify a set of objectives and strategies for achieving goals and desired results, to better coordinate ongoing efforts to preserve, protect, and enhance the water resources of the Basin, and to identify additional needs for more effective water resources management. In order to address these objectives, the Basin Plan developed five key result areas (KRAs) which are listed below:

- KRA 1 Sustainable use and Supply of water
- KRA 2 Waterway Corridor Management
- KRA 3 Linking Land and Water Resources Management
- KRA 4 Institutional Coordination and Cooperation
- KRA 5 Education and Involvement for Stewardship

## 1.6 EVOLUTION OF OBJECTIVES

As the first major undertaking in terms of advancing the Basin Plan, the Corps met with DRBC and other agencies to focus the study's efforts on key goals addressed in the Basin Plan. Through further review of the original proposal, it was determined that Task 1 (Long Term sufficiency of water) and Task 3 (Provision of timely and easily accessible information to the public) would remain as originally described in the original proposal. However, Task 2 (Effective, long-term flow management) which consisted of three sub-tasks (1) estuary inflow evaluation, (2) multi-jurisdictional flood risk management and (3) re-evaluation of DRBC's approach to Water Supply User Costs would be broken into three separable tasks rather than sub-tasks. This decision was in part due to the recent flood events which had occurred in 2004, 2005 and 2006 causing devastation throughout the Basin. Due to concerns from the locals, it was essential that the study not only evaluated water supply in-depth but also took a closer look at flood risk management.

The following sections of this report will provide problem identification for each task, a review of the analysis conducted and will summarize the findings of the analysis with a list of potential alternatives that should be evaluated in greater detail.

Below is a figure showing how the KRAs from the Basin Plan translate to the goals of this study.

Task 1: Long Term Sufficiency of Water Supply	⇒	KRA 1: Sustainable Use and Supply
Task 2: Flood Risk Management	⇒	KRA 2: Waterway Corridor Management
Task 3: Estuary Inflow	⇒	KRA 1: Sustainable Use and Supply
Task 4: User Supply Costs	⇒	KRA 1: Sustainable Use and Supply
Task 5: GIS/Public Outreach	⇒	KRA 5: Education and Involvement for Stewardship

## 1.7 STUDY AREA

The Delaware River is the longest “free-flowing” river in the eastern United States. It originates on the western slopes of the Catskill Mountains in eastern New York, at elevations ranging from 2,500 and 3,000 feet, mean sea level. The West Branch of the Delaware River and the East Branch of the Delaware River flow southwesterly and join at Hancock, New York, to form the Delaware River. From this point, the river flows southeasterly along the New York-Pennsylvania boundary to Port Jervis, New York where it emerges into the valley at an elevation of approximately 420 feet, thence flows southwesterly to Stroudsburg, Pennsylvania, where it turns sharply to the southeast and cuts through the mountains at the Delaware Water Gap, and continues in this general direction to Trenton, New Jersey. Its character changes at Trenton, where it flows over a series of rock ledges at the Fall Line and enters the tidal estuary. From Trenton to the vicinity of Wilmington, Delaware, the river flows southwesterly along the Fall Line, then turns oceanward to enter Delaware Bay at Liston Point, and finally reaches the ocean between Cape May, New Jersey and Cape Henlopen, Delaware. Below Port Jervis, New York, the river forms the boundary between New Jersey on the east, and Pennsylvania and Delaware on the West.

Between Hancock and Port Jervis, the river is joined by the Lackawaxen River in Pennsylvania and Mongaup River in New York. The Neversink River enters from the New York side at Port Jervis. No large tributaries enter the river between this point and the Delaware Water Gap. Downstream to Trenton, the Lehigh River enters from the west at Easton, Pennsylvania, and drainage from the east in New Jersey is mainly by the Paulins Kill, Beaver Brook, and the Pequest and Musconetcong Rivers. Other main tributaries from the west include the Schuylkill River at Philadelphia, Pennsylvania and the Christina River at Wilmington, Delaware.

The river is fed by 216 tributaries, the largest being the Schuylkill and Lehigh Rivers in Pennsylvania. In all, the basin contains 13,539 square miles, draining parts of Pennsylvania (6,422 square miles or 50.3 percent of the basin's total land area); New Jersey (2,969 square miles, or 23.3%); New York (2,362 square miles, 18.5%); and Delaware (1,002 square miles, 7.9%).

Almost ten percent of the nation's population relies on the waters of the Delaware River Basin for drinking and industrial use, yet the basin drains only four-tenths of one percent of the total continental U.S. land area.

Two stretches of the Delaware River, extending 107 miles from Hancock, N.Y. to the Delaware Water Gap, have been included in the National Wild and Scenic Rivers System. The two designated river corridors total 124,929 acres.

Currently the river has a 40' channel as far inland as Philadelphia, allowing oceangoing vessels into its ports and a 35' channel to Trenton, New Jersey. The Chesapeake and Delaware Canal connects the Delaware River below Wilmington Delaware, with Chesapeake Bay. The canal is also navigable by oceangoing vessels.

The Delaware River is the political divide between New York, Pennsylvania, New Jersey and Delaware. The land within these four states is further subdivided into 42 counties, and 838 cities, town, boroughs and townships. Congressional interest includes: Senators: Clinton (NY), Schumer (NY), Lautenberg (NJ), Menendez (NJ), Casey (PA), Specter (PA) Biden (DE) Carper (DE), Representatives Castle (DE-AL), Andrews (NJ-1), LoBiondo (NJ-2), Saxton (NJ-3), Smith (NJ-4), Garrett (NJ-5), Ferguson (NJ-7), Frelinghuysen (NJ-11), Holt (NJ-12), Hall (NY-19), Gillibrand (NY-20), Hinchey (NY-22), Brady (PA-1), Fattah (PA-2), Gerlach (PA-6), Sestak (PA-7), Murphy (PA-8), Carney (PA-10), Kanjorski (PA-11), Schwartz (PA-13), Dent (PA-15), Pitts (PA-16), Holden (PA-17).

## 2.0 LONG TERM SUFFICIENCY OF WATER SUPPLY THROUGH 2030

Water supply and storage have always been a key concern for the Basin but particularly during times of drought, especially during the 1930's and 1960's and more recently but to a lesser extent from 1981 through 1983. With water shortages of these magnitudes, total water use or non-consumptive use becomes a problem to many areas because the demand for water exceeds the available supply. Some of these problems are local, such as individual well failure or contamination. Other problems are area-wide such as aquifer depletion from excessive withdrawal or contamination. As a result, allocated diversions and reservoir releases are cut back, which spreads the problem beyond the geographical limits of the Basin. This situation intensifies due to groundwater failures and salinity intrusion into the already depleted sources of fresh water. Problems with un-sustained stream flow, treated waste assimilation, acid mine drainage, salinity intrusion, and even impeding of fish migration and production then result.

While three of the four Basin-states are currently undertaking their own water supply planning efforts, this study is intended to complement the work underway and also provide a uniform Basin perspective. Efforts have been made to coordinate this study with the work of the individual states. A brief summary of the water supply work ongoing in the states of Delaware, New Jersey and Pennsylvania is provided below.

**Delaware.** Delaware has taken a regional approach to water supply planning, through its Water Supply Coordinating Council (WSCC) which initially focused on expanding water supplies in northern New Castle County. Ten projects were identified for development to help ensure demand would be met through 2020, this includes the 317 million gallon Newark Reservoir, the first in Delaware for over 70 years, which came online in 2006. Once all projects are online, an additional 2 billion gallons of storage will be available for northern New Castle County. In 2003, legislation directed the WSCC to expand water supply planning to three other key areas of the state, southern New Castle County, central Kent County and coastal Sussex County. Planning work in these areas is currently underway and on schedule for completion by the end of 2009, at which point the authorization for the WSCC will expire. A separate study of ground water availability conducted by the Army Corps of Engineers concluded that groundwater withdrawals in Delaware affect the aquifer system in Maryland and New Jersey.

**New Jersey.** New Jersey is planning to release its latest Statewide Water Supply Plan in 2008. New Jersey's assessment will include a comparison of consumptive and depletive water demands versus water availability using the low flow margin method (a measure based on September median flow minus  $Q_{7-10}$ ). The plan will also include an assessment of water demand versus infrastructure capacity. Two scenarios of future water demand have been developed, one is a projection to the year 2020 and the other is a "full allocation" scenario, where water demand is modeled based on water allocation permit limits.

**Pennsylvania.** Act 220 legislation in Pennsylvania led to the creation of a new State Water Plan which is due for release in 2008. At the heart of the plan is a GIS-based water budget assessment which evaluates the water balance at over 10,000 “pour points” across the state. Net water withdrawals (water withdrawn minus discharges) are compared to an availability threshold of 50% (30% in carbonate areas) of the Q<sub>7</sub>10 value. A number of watersheds have been identified statewide (six in the Delaware River Basin portion of the state) for closer scrutiny in the “final verification” phase. These watersheds will be evaluated for potential consideration as Critical Water Planning Areas. Watersheds receiving such designation will require a Critical Area Resource Plan to be developed, which will identify the exact nature of the supply-demand imbalance and will identify potential mitigation strategies.

## **2.1 WATER AVAILABILITY ANALYSIS**

**2.1.1 Basin Delineation** In assessments of water supply and demand, the selection of an appropriate watershed scale is a key factor that will determine the applicability of the study’s findings. The choice of scale must be consistent with the objectives of the study and the data that are available for the assessment.

An analysis of alternative watershed scales in the Delaware River Basin was performed as part of this study. It should be noted that for some of the smaller watershed scales, there is a lack of consistency between Basin states in delineating watersheds. The maps presented in figures 2.1-2.6 below, illustrate watershed delineations for the Delaware River Basin that have been used in previous studies; they do not necessarily conform exactly to the delineations developed by the United States Geological Survey (USGS) and the Natural Resources Conservation Service (NRCS), which are the two main agencies responsible for developing watershed delineations.



Figure 2.1 HUC 8 Watersheds:



Figure 2.2 HUC 11 Watersheds:



Figure 2.3 HUC 14 Watersheds:



Figure 2.4 Basin Plan Sub-basins:



Figure 2.5 Flow Management Sub-basins

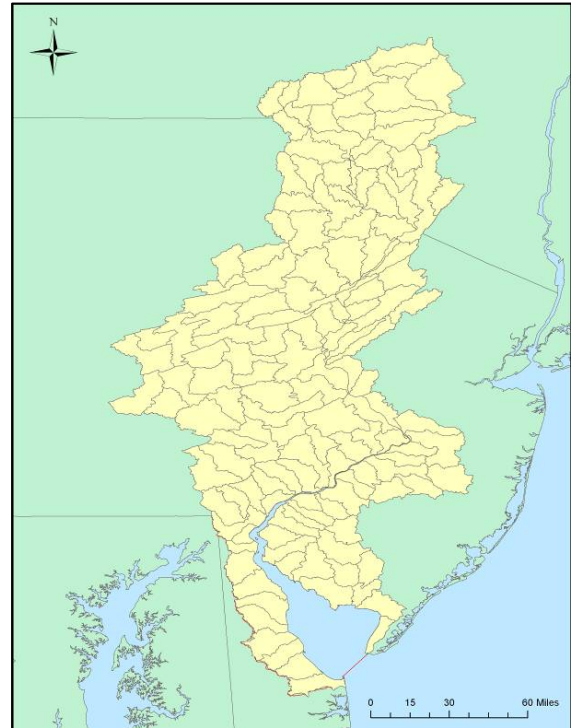

Figure 2.6\* USGS Ground-Water Avail. Sub-basins

Basic descriptive statistics for each of the watershed scale classifications are shown in Table 2.1. Based on a review of the alternative sub-basin scales, it was recommended that this study use the 147 sub-basins delineated by the USGS in a recent project undertaken to quantify ground-water availability<sup>1</sup> for the entire Delaware River Basin. This approach is appropriate for the purposes of this study as there are sufficient data available to support an assessment of supply and demand issues at this scale. In addition, the use of 147 sub-basins will provide a more detailed regional picture than in previous studies conducted for the Delaware River Basin. A detailed map of the 147 watersheds is shown in Figure 2.7; Table 2.2 is a reference table to the map that includes the basin ID, location, size and key streams in each watershed.

<sup>1</sup> Sloto, R. A. and Buxton, D. E., 2006 , Estimated Ground-Water Availability in the Delaware River Basin, 1997-2000: U.S. Geological Survey Scientific Investigations Report 2006-5125 Version 1.1



Table 2.1  
Summary of Watershed Scale Characteristics

<b>Scale</b>	<b>Count</b>	<b>Mean Size (sq mi.)</b>	<b>Median Size (sq mi.)</b>	<b>Max Size (sq mi.)</b>	<b>Min Size (sq mi.)</b>
HUC 8	12	1,070	1,073	1,910	542
HUC 11	236	54.5	32.9	536	1.2
HUC 14	3,237	2.0	3.9	56.2	0.1
Basin Plan SB	10	1,287	1,406	2,028	449
Flow Mgmt SB	17	757	449	3,430	38
USGS Study SB	147	87	82	210	18



Figure 2.7 Delineation of Sub-Basins

Table 2.2  
Basin Identification

Basin ID No.	Drainage Area (mi <sup>2</sup> )	State	Streams
DB-001	144.0	NY	Upper part of West Branch Delaware River
DB-002	52.3	NY	Little Delaware River
DB-003	82.8	NY	Middle part of West Branch Delaware River
DB-004	53.1	NY	Upper part of West Branch Delaware River and East Branch Delaware River
DB-005	123.0	NY	Lower part of West Branch Delaware River
DB-006	39.2	NY	Cold Spring Creek, Butler Brook, Bone Creek
DB-007	67.8	NY	Oquaga Creek
DB-008	42.5	NY	Whitaker Brook, Rhoads Creek, Cadonia Creek, City Brook, Read Creek (tributaries to Delaware River)
DB-009	62.1	PA/NY	Faulkner Brook, Balls Creek, Shehawken Creek, Sherman Creek
DB-010	210.0	NY	Upper part of East Branch Delaware River above Platte Kill
DB-011	161.0	NY	Upper part of East Branch Delaware River and tributaries to Pepacton Reservoir
DB-012	97.1	NY	Upper part of Beaver Kill
DB-013	133.0	NY	Willowemoc Creek
DB-014	91.5	NY	Middle part of East Branch Delaware River below Pepacton Reservoir
DB-015	70.0	NY	Lower part of Beaver Kill
DB-016	78.5	NY	Lower part of East Branch Delaware River
DB-017	82.5	NY	Hankins Creek, Basket Creek, Hoolihan Creek, Abe Lord Creek, Humphries Creek, Blue Mill Stream (tributaries to Delaware River)
DB-018	122.0	PA	Equinunk Creek
DB-019	35.7	NY	East Branch Callicoon Creek
DB-020	76.2	NY	North Branch Callicoon Creek
DB-021	25.8	NY	Unnamed tributaries to Delaware River
DB-022	80.1	PA	Calkins Creek, Cooley Creek, Hollister Creek, Beaverdam Creek, Peggy Run (tributaries to Delaware River)
DB-023	59.2	NY	Ten Mile River
DB-024	39.4	PA	Masthope Creek, Westcolong Creek (tributaries to Delaware River)
DB-025	92.2	PA	West Branch Lackawaxen River
DB-026	70.0	PA	Dyberry Creek
DB-027	82.2	PA	Middle Creek
DB-028	126.0	PA	Lackawaxen River
DB-029	88.8	NY	Fish Cabin Creek, Mill Brook, Halfway Brook, Beaver Brook, Narrow Falls Brook, Grassy Swamp Brook (tributaries to Delaware River)
DB-030	67.5	PA	West Branch Wallenpaupack Creek
DB-031	160.0	PA	Wallenpaupack Creek
DB-032	92.6	PA	Shohola Creek, Panther Creek (tributaries to Delaware River)
DB-033	77.9	NY	Mongaup River above Swinging Bridge Reservoir
DB-034	40.3	NY	Mongaup River tributaries to Swinging Bridge Reservoir
DB-035	111.0	NY	Mongaup River below Swinging Bridge Reservoir, Shingle Kill
DB-036	80.2	PA	Walker Lake Creek, Pond Eddy Creek, Cummins Creek, Sawkill Creek, Crowth Branch (tributaries to Delaware River)
DB-037	92.7	NY	Neversink River above Neversink Reservoir
DB-038	197.0	NY/NJ	Neversink River below Neversink Reservoir
DB-039	72.5	NY	Basher Kill

Table 2.2  
Basin Identification (Continued)

Basin ID No.	Drainage Area (mi <sup>2</sup> )	State	Streams
DB-040	88.5	PA	Raymondskill Creek, Dingmans Creek, Conashaugh Creek, Dry Brook, Adams Creek, Hornbecks Creek, Toms Creek (tributaries to Delaware River)
DB-041	17.9	NJ	Unnamed tributaries to Delaware River
DB-042	66.2	NJ	Flat Brook
DB-043	158.0	PA	Bush Kill
DB-044	30.7	NJ	Vancampens Brook, Dunnfield Creek, and tributaries to Delaware River
DB-045	174.0	PA	Brodhead Creek
DB-046	114.0	PA	Pocono Creek
DB-047	34.8	PA	Cherry Creek, Caledonia Creek (tributaries to Delaware River)
DB-048	30.2	PA	Slateford Creek, Jacoby Creek, Allegheny Creek (tributaries to Delaware River)
DB-049	107.0	NJ	Paulins Kill above Stillwater Village, Trout Brook
DB-050	69.8	NJ	Paulins Kill below Stillwater Village
DB-051	48.8	NJ	Stony Brook, Delawanna Creek, Beaver Brook
DB-052	120.0	NJ	Pequest River
DB-053	74.9	PA	Martins Creek, Mud Run (tributaries to Delaware River)
DB-054	47.9	NJ	Pophandusing Brook, Buckhorn Creek, Lopatcong Creek, and tributaries to Delaware River
DB-055	79.9	PA	Bush Kill
DB-056	93.2	PA	Upper part of Lehigh River
DB-057	129.0	PA	Tobyhanna Creek
DB-058	91.1	PA	Bear Creek
DB-059	49.4	PA	Middle part of Lehigh River above Sandy Run
DB-060	149.0	PA	Middle part of Lehigh River above Black Creek
DB-061	117.0	PA	Middle part of Lehigh River above Pohopoco Creek
DB-062	111.0	PA	Pohopoco Creek
DB-063	113.0	PA	Lower part of Lehigh River
DB-064	78.3	PA	Aquashicola Creek
DB-065	91.8	PA	Lower part of Lehigh River above Little Lehigh Creek
DB-066	106.0	PA	Jordan Creek
DB-067	83.8	PA	Little Lehigh Creek
DB-068	149.0	PA	Lower part of Lehigh River below Little Lehigh Creek
DB-069	58.2	NJ	Pohatcong Creek
DB-070	81.7	NJ	Musconetcong River above Trout Brook
DB-071	73.9	NJ	Musconetcong River below and including Trout Brook
DB-072	96.9	PA	Frya Run, Cooks Creek, Tincum Creek, and tributaries to Delaware River
DB-073	62.5	NJ	Harihokake Creek, Nishisakawick Creek, and tributaries to Delaware River
DB-074	112.0	PA	Tohickon Creek
DB-075	54.4	NJ	Lockatong Creek, Wickecheoke Creek, and tributaries to Delaware River
DB-076	77.3	PA	Geddes Run, Hickory Creek, Paunnacussing Creek, Aquetong Creek, Hollow Run, Pidcock Creek, Jericho Creek, Houghs Creek, Dyers Creek
DB-077	62.5	NJ	Alexauken Creek, Moores Creek, Jacobs Creek, and tributaries to Delaware River
DB-078	95.7	NJ	Assunpink Creek
DB-079	54.0	PA	Martins Creek and tributaries to Delaware River

Table 2.2  
Basin Identification (Continued)

Basin ID No.	Drainage Area (mi <sup>2</sup> )	State	Streams
DB-080	144.0	NJ	Crosswicks Creek
DB-081	52.3	NJ	Crafts Creek, Black Creek, and tributaries to Delaware River
DB-082	53.1	NJ	Assiscunk Creek and tributaries to Delaware River
DB-083	168.0	PA	Neshaminy Creek above Little Neshaminy Creek
DB-084	65.1	PA	Neshaminy Creek below Little Neshaminy Creek
DB-085	110.0	NJ	North Branch Rancocas Creek above New Lisbon Dam, Greenwood Branch
DB-086	68.6	NJ	South Branch Rancocas Creek above Bobbys Run
DB-087	76.0	NJ	South Branch Rancocas Creek above South West Branch
DB-088	95.8	NJ	Rancocas Creek main stem with North Branch below New Lisbon Dam and South Branch below Bobbys Run
DB-089	80.2	PA	Poquessing Creek, Pennypack Creek, and tributaries to Delaware River
DB-090	56.2	NJ	Pennsauken Creek, Pompeston Creek, and tributaries to Delaware River
DB-091	65.7	PA	Frankford Creek and tributaries to Delaware River
DB-092	51.3	NJ	Cooper River
DB-093	98.9	NJ	Woodbury Creek, Big Timber Creek, Newton Creek, and tributaries to Delaware River
DB-094	137.0	PA	Little Schuylkill River
DB-095	66.9	PA	Upper part of Schuylkill River above Pottsville
DB-096	138.0	PA	Upper part of Schuylkill River below Pottsville
DB-097	107.0	PA	Tributaries to middle part of Schuylkill River
DB-098	90.8	PA	Maiden Creek above Sacony Creek
DB-099	125.0	PA	Maiden Creek below Sacony Creek
DB-100	131.0	PA	Upper part of Tulpehocken Creek above Blue Marsh Reservoir
DB-101	88.3	PA	Lower part of Tulpehocken Creek below Blue Marsh Reservoir
DB-102	170.0	PA	Tributaries to middle part of Schuylkill River
DB-103	91.5	PA	Manatawny Creek
DB-104	140.0	PA	Lower part of Schuylkill River and tributaries above Skippack Creek
DB-105	70.2	PA	French Creek
DB-106	144.0	PA	West Branch Perkiomen Creek
DB-107	134.0	PA	Perkiomen Creek above and including East Branch
DB-108	84.0	PA	Perkiomen Creek below East Branch
DB-109	129.0	PA	Lower part of Schuylkill River and tributaries below Skippack Creek
DB-110	63.7	PA	Wissahickon Creek
DB-111	50.2	NJ	Mantua Creek
DB-112	81.6	PA	Darby Creek
DB-113	41.0	NJ	Cedar Swamp, Repaupo Creek, Clonmell Creek, and tributaries to Delaware River
DB-114	77.2	PA	Crum Creek, Ridley Creek, Marcus Hook Creek
DB-115	66.4	PA	Chester Creek
DB-116	40.9	PA/DE	Naamans Creek, Shellpot Creek, and tributaries to Delaware River
DB-117	49.7	NJ	Raccoon Creek, Birch Creek
DB-118	44.0	NJ	Oldmans Creek
DB-119	72.0	NJ	Salem River above dam, Salem Canal, and tributaries to Delaware Bay
DB-120	123.0	PA	East Branch Brandywine Creek
DB-121	135.0	PA	West Branch Brandywine Creek
DB-122	65.2	PA/DE	Brandywine Creek (main stem)
DB-123	56.1	PA/DE	Red Clay Creek

Table 2.2  
Basin Identification (Continued)

Basin ID No.	Drain- age Area (mi <sup>2</sup> )	State	Streams
DB-124	104.0	PA/DE	White Clay Creek
DB-125	85.0	DE	Christina River and tributaries to Delaware River
DB-126	68.8	NJ	Salem River below dam and tributaries to Delaware Bay
DB-127	31.5	DE	Army Creek, Red Lion Creek, Dragon Creek, and tributaries to Delaware River
DB-128	32.4	DE	C and D Canal and tributaries to Delaware Bay
DB-129	77.7	NJ	Alloway Creek, Hope Creek, and tributaries to Delaware Bay
DB-130	91.1	DE	Augustine Creek, Appoquinimik River, Blackbird Creek, and tributaries to Delaware Bay
DB-131	55.2	NJ	Stow Creek and tributaries to Delaware Bay
DB-132	99.7	DE	Smyrna River, Duck Creek, Mill Creek, and tributaries to Delaware Bay
DB-133	107.0	NJ	Cohansey River
DB-134	111.0	NJ	Back Creek, Cedar Creek, Nantuxent Creek, Dividing Creek, and tributaries to Delaware Bay
DB-135	101.0	DE	Leipsic River, Simons River, Little River, and tributaries to Delaware Bay
DB-136	75.9	NJ	Scotland Run, Still Run, Little Ease Run
DB-137	115.0	NJ	Maurice River above Sherman Avenue Bridge and Muddy Run
DB-138	69.7	NJ	Maurice River above Menantico Creek
DB-139	75.4	NJ	Menantico Creek, Manumuskin River
DB-140	48.9	NJ	Maurice River below Menantico Creek
DB-141	86.5	NJ	West Creek, East Creek, Dennis Creek, and tributaries to Delaware Bay
DB-142	45.2	NJ	Tributaries to Delaware Bay
DB-143	88.3	DE	Saint Jones River
DB-144	104.0	DE	Murderkill River
DB-145	74.8	DE	Misspillion River and tributaries to Delaware Bay
DB-146	83.3	DE	Cedar Creek, Slaughter Creek, Primehook Creek, and tributaries to Delaware Bay
DB-147	83.5	DE	Round Pole Branch and tributaries to Delaware Bay

Once sub-basins were identified, the team assessed current and future water demands for key water using sectors in the Basin through the year 2030 and evaluated them against indicators of ground and surface water availability through a river analysis for the Delaware, Schuylkill and Lehigh Rivers and a watershed analysis for each of the 147 sub-basins. The analysis quantifies the following:

- Withdrawals and consumptive use
- Peak month and average annualized demand
- Surface and ground water supply

This report serves as a reconnaissance level summary of water supply and demand for the 147 sub-basins and the Delaware, Schuylkill and Lehigh Rivers and should not be considered to be all inclusive in its recommendations for meeting water deficits, but should rather be considered as an aid in assisting future water supply planning efforts.

**2.1.2 Ground-Water Availability.** Different methods were used to estimate ground-water availability for the region underlain by fractured rocks in the upper part of the basin and for surficial aquifers in the region underlain by unconsolidated sediments in the lower part of the basin. The methodology is similar to that used for the DRBC's Ground-Water Protected Area (GWPA) in southeastern Pennsylvania. The DRBC delineated the GWPA in 1980 in response to increases in population and water demand in the region, which were responsible for interference and conflict among users of the same ground water resource. The GWPA Regulations were amended in 1998 to include numerical withdrawal limits (equivalent to the 1-year-in-25-year baseflow rate) for the 76 subbasins and establish a potentially stressed watershed status corresponding to 75% of the withdrawal limit. Figure 2.8 shows the GWPA delineation and also another area vulnerable to ground water withdrawals, the New Jersey Water Supply Critical Area 2 where additional management efforts are in place to protect ground water resources.

In the USGS report, estimates of ground-water availability for the 109 watersheds underlain by fractured rocks were based on lithology and physiographic province. Lithology was generalized by grouping geologic units into 14 categories on the basis of rock type and physiographic province. Twenty-three index streamflow-gaging stations were identified to represent the 14 categories. A base-flow-recurrence analysis was performed to determine the average annual 2-, 5-, 10-, 25-, and 50-year-recurrence intervals for each index station. A GIS analysis then used lithology and base flow at the index stations to determine the average annual base flow for each of the 109 watersheds.

Ground-water availability for watersheds underlain by unconsolidated surficial aquifers was based on predominant surficial geology and land use, which were determined from statistical analyses to be the most significant controlling factors of base flow. Twenty-one index streamflow-gaging stations were selected to represent the 13 categories of predominant surficial geology and land use for the 38 Coastal Plain watersheds. A base-flow-recurrence analysis was also used to determine the average annual 2-, 5-, 10-, 25-, and 50-year-recurrence intervals for each group of predominant surficial geology and land use.

The range of recurrence intervals are chosen to be representative of the quantity of ground water available for each watershed over a range of climatic conditions. The recurrence intervals are considered to be relative indicators of climatic difference; for example, the 2-year-recurrence value represents wetter years and the 50-year-recurrence value represents drier years. The DRBC uses the 25-year-recurrence interval to set withdrawal limits for each of the sub-basins delineated in the GWPA. For the purposes of this study, the 25-year-recurrence interval will be used as the primary benchmark for evaluating ground-water availability. The choice of this indicator is based primarily upon its use for ground water management purposes in the GWPA over the past decade.

Table 2.3 displays ground-water availability for each of the 147 watersheds of the Delaware River Basin. Both million gallons per square mile per day (MG/mi<sup>2</sup>/d) and million gallons per day (MG/d), were calculated for each watershed.

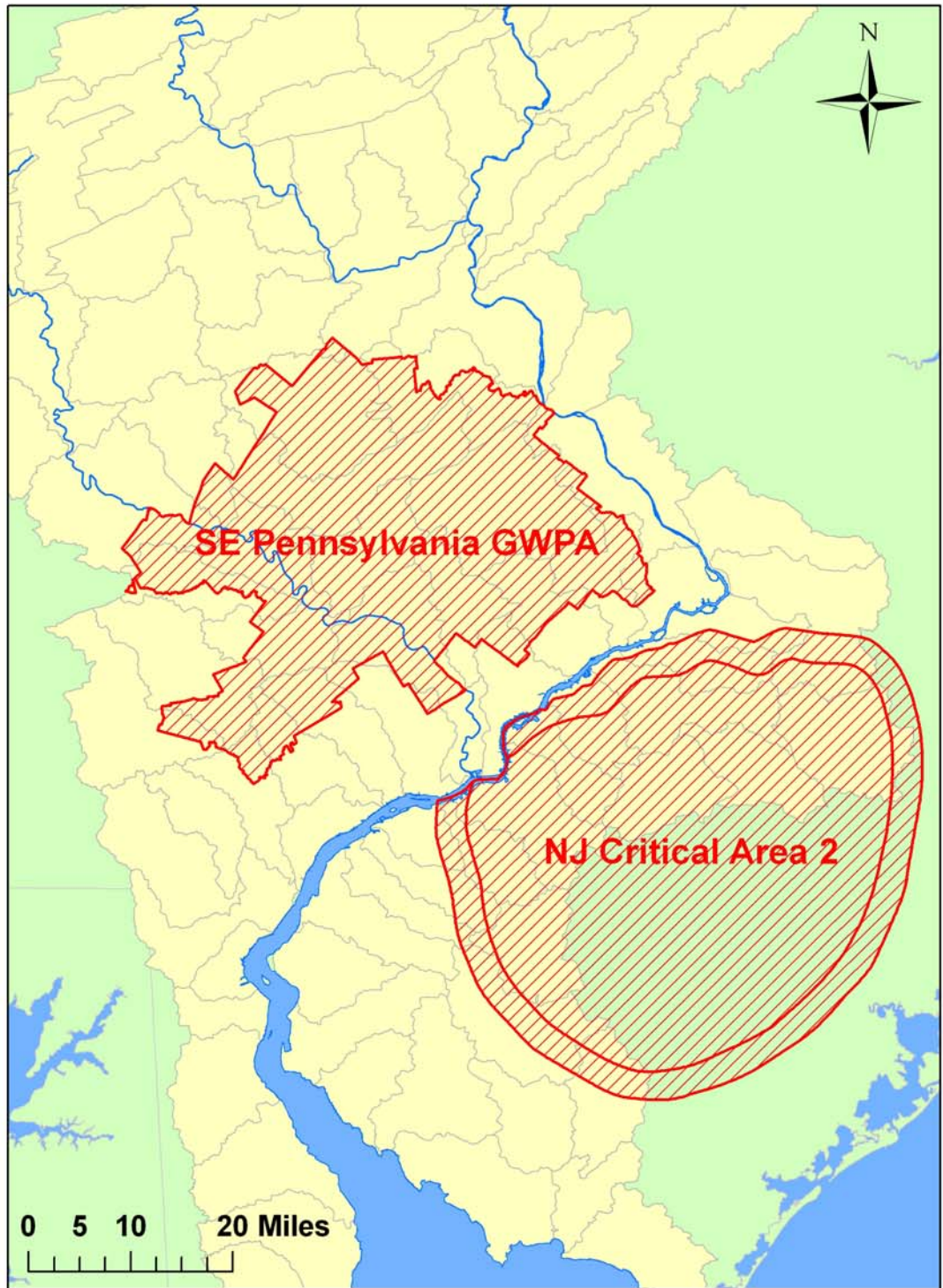

Figure 2.8 The Ground Water Protected Area (GWPA) in southeastern Pennsylvania and the New Jersey Water Supply Critical Area 2



Table 2.3  
Ground Water Availability

Basin ID number	MG/mi <sup>2</sup> /d			MG/d		
	2-yr RI	10-yr RI	25-yr RI	2-yr RI	10-yr RI	25-yr RI
DB-001	0.687	0.492	0.403	98.833	70.812	57.975
DB-002	0.687	0.492	0.403	35.923	25.738	21.072
DB-003	0.687	0.492	0.403	56.948	40.802	33.405
DB-004	0.687	0.492	0.403	36.488	26.143	21.403
DB-005	0.701	0.501	0.412	85.938	61.452	50.562
DB-006	0.691	0.495	0.406	27.121	19.418	15.915
DB-007	0.704	0.503	0.415	47.727	34.063	28.109
DB-008	0.763	0.542	0.456	32.396	23.003	19.336
DB-009	0.855	0.620	0.537	53.101	38.500	33.315
DB-010	0.695	0.497	0.408	146.043	104.389	85.730
DB-011	0.697	0.498	0.410	112.480	80.354	66.110
DB-012	0.753	0.524	0.446	73.123	50.846	43.342
DB-013	0.748	0.515	0.442	99.120	68.221	58.493
DB-014	0.721	0.514	0.426	66.000	47.030	38.994
DB-015	0.711	0.477	0.414	49.735	33.347	28.947
DB-016	0.744	0.513	0.439	58.341	40.225	34.425
DB-017	0.636	0.394	0.356	52.506	32.470	29.341
DB-018	0.870	0.635	0.550	108.894	79.447	68.870
DB-019	0.586	0.347	0.318	20.882	12.358	11.331
DB-020	0.692	0.444	0.396	52.699	33.865	30.208
DB-021	0.573	0.336	0.309	14.805	8.667	7.973
DB-022	0.874	0.639	0.553	70.010	51.172	44.328
DB-023	0.578	0.340	0.312	34.250	20.152	18.504
DB-024	0.875	0.639	0.554	34.486	25.211	21.842
DB-025	0.874	0.640	0.554	80.574	59.058	51.089
DB-026	0.875	0.639	0.554	61.233	44.765	38.783
DB-027	0.865	0.648	0.555	71.134	53.252	45.633
DB-028	0.874	0.640	0.554	110.184	80.656	69.825
DB-029	0.718	0.504	0.423	63.784	44.811	37.563
DB-030	0.861	0.651	0.555	58.151	43.954	37.503
DB-031	0.865	0.647	0.555	138.249	103.418	88.688
DB-032	0.874	0.640	0.554	80.937	59.247	51.291
DB-033	0.705	0.502	0.415	54.946	39.124	32.354
DB-034	0.695	0.497	0.408	28.037	20.060	16.478
DB-035	0.711	0.507	0.420	78.688	56.122	46.459
DB-036	0.840	0.624	0.537	67.432	50.064	43.093
DB-037	0.727	0.516	0.430	67.388	47.772	39.855
DB-038	0.708	0.514	0.427	139.729	101.457	84.311
DB-039	0.725	0.531	0.445	52.533	38.478	32.285
DB-040	0.826	0.617	0.530	73.178	54.682	46.943

Table 2.3  
Ground Water Availability (Continued)

Basin ID number	MG/mi <sup>2</sup> /d			MG/d		
	2-yr RI	10-yr RI	25-yr RI	2-yr RI	10-yr RI	25-yr RI
DB-041	0.810	0.610	0.522	14.562	10.965	9.386
DB-042	0.715	0.530	0.459	47.373	35.133	30.427
DB-043	0.864	0.635	0.549	136.037	99.967	86.432
DB-044	0.671	0.499	0.431	20.598	15.309	13.216
DB-045	0.857	0.634	0.546	149.126	110.217	95.020
DB-046	0.841	0.626	0.539	95.793	71.257	61.312
DB-047	0.734	0.547	0.472	25.556	19.025	16.436
DB-048	0.532	0.415	0.358	16.081	12.543	10.817
DB-049	0.582	0.426	0.354	62.388	45.672	37.906
DB-050	0.579	0.424	0.351	40.425	29.632	24.503
DB-051	0.583	0.425	0.352	28.543	20.831	17.234
DB-052	0.670	0.454	0.361	80.643	54.629	43.530
DB-053	0.559	0.421	0.356	41.934	31.603	26.672
DB-054	0.688	0.452	0.349	33.023	21.685	16.777
DB-055	0.588	0.423	0.346	46.983	33.828	27.653
DB-056	0.864	0.651	0.557	80.503	60.646	51.925
DB-057	0.860	0.650	0.555	110.996	83.928	71.602
DB-058	0.895	0.650	0.574	81.566	59.261	52.264
DB-059	0.913	0.650	0.583	45.118	32.101	28.782
DB-060	0.899	0.650	0.575	134.059	97.035	85.792
DB-061	0.866	0.636	0.555	101.570	74.601	65.142
DB-062	0.846	0.629	0.541	93.828	69.812	60.014
DB-063	0.677	0.516	0.447	76.495	58.280	50.473
DB-064	0.793	0.590	0.508	62.126	46.190	39.801
DB-065	0.579	0.421	0.347	53.134	38.683	31.810
DB-066	0.566	0.419	0.348	60.011	44.385	36.851
DB-067	0.688	0.451	0.348	57.619	37.796	29.151
DB-068	0.658	0.436	0.339	97.858	64.882	50.464
DB-069	0.686	0.464	0.372	39.914	26.982	21.647
DB-070	0.682	0.485	0.413	55.694	39.585	33.706
DB-071	0.666	0.459	0.373	49.254	33.924	27.572
DB-072	0.448	0.303	0.251	43.455	29.389	24.312
DB-073	0.372	0.254	0.213	23.298	15.933	13.347
DB-074	0.313	0.211	0.175	35.100	23.633	19.650
DB-075	0.364	0.246	0.207	19.836	13.407	11.290
DB-076	0.449	0.300	0.253	34.752	23.193	19.588
DB-077	0.356	0.240	0.202	22.267	15.055	12.651
DB-078	1.028	0.822	0.671	98.343	78.636	64.191
DB-079	0.524	0.331	0.290	28.307	17.886	15.657
DB-080	0.563	0.379	0.327	81.231	54.683	47.181
DB-081	0.563	0.379	0.327	29.462	19.833	17.112
DB-082	0.774	0.558	0.504	41.104	29.633	26.765

Table 2.3  
Ground Water Availability (Continued)

Basin ID number	MG/mi <sup>2</sup> /d			MG/d		
	2-yr RI	10-yr RI	25-yr RI	2-yr RI	10-yr RI	25-yr RI
DB-083	0.439	0.298	0.252	73.923	50.090	42.496
DB-084	0.543	0.359	0.312	35.349	23.358	20.298
DB-085	0.774	0.558	0.504	85.399	61.566	55.608
DB-086	0.774	0.558	0.504	53.119	38.295	34.589
DB-087	0.774	0.558	0.504	58.862	42.435	38.329
DB-088	0.774	0.558	0.504	74.174	53.474	48.299
DB-089	0.540	0.348	0.303	43.332	27.964	24.343
DB-090	0.619	0.443	0.393	34.790	24.898	22.088
DB-091	0.523	0.330	0.289	34.381	21.701	18.988
DB-092	0.619	0.443	0.393	31.752	22.724	20.159
DB-093	0.619	0.443	0.393	61.238	43.826	38.880
DB-094	0.849	0.615	0.543	116.230	84.167	74.311
DB-095	0.915	0.650	0.584	61.182	43.463	39.033
DB-096	0.832	0.610	0.534	115.183	84.428	73.866
DB-097	0.562	0.424	0.360	60.311	45.569	38.661
DB-098	0.526	0.419	0.367	47.744	38.030	33.282
DB-099	0.607	0.431	0.349	76.133	53.985	43.814
DB-100	0.605	0.427	0.344	79.278	55.953	45.077
DB-101	0.588	0.427	0.355	51.949	37.743	31.339
DB-102	0.525	0.356	0.297	89.166	60.395	50.370
DB-103	0.616	0.425	0.351	56.368	38.926	32.116
DB-104	0.458	0.299	0.250	63.963	41.703	34.865
DB-105	0.527	0.346	0.300	36.986	24.287	21.087
DB-106	0.433	0.300	0.253	62.436	43.193	36.479
DB-107	0.341	0.231	0.193	45.698	30.979	25.838
DB-108	0.325	0.219	0.183	27.288	18.420	15.357
DB-109	0.552	0.357	0.302	71.313	46.114	39.039
DB-110	0.534	0.349	0.292	33.993	22.254	18.616
DB-111	0.619	0.443	0.393	31.048	22.220	19.712
DB-112	0.524	0.331	0.289	42.713	26.975	23.608
DB-113	1.169	0.780	0.688	47.958	32.000	28.225
DB-114	0.523	0.330	0.289	40.387	25.492	22.306
DB-115	0.524	0.331	0.289	34.750	21.946	19.207
DB-116	0.514	0.325	0.284	21.033	13.295	11.626
DB-117	0.524	0.353	0.344	26.055	17.553	17.105
DB-118	0.524	0.353	0.344	23.077	15.546	15.150
DB-119	1.169	0.780	0.688	84.120	56.128	49.508
DB-120	0.543	0.343	0.292	66.972	42.279	36.062
DB-121	0.532	0.336	0.290	71.788	45.289	39.198
DB-122	0.524	0.331	0.289	34.146	21.564	18.872
DB-123	0.533	0.336	0.291	29.890	18.860	16.304

Table 2.3  
Ground Water Availability (Continued)

Basin ID number	MG/mi <sup>2</sup> /d			MG/d		
	2-yr RI	10-yr RI	25-yr RI	2-yr RI	10-yr RI	25-yr RI
DB-124	0.534	0.337	0.291	55.511	35.044	30.252
DB-125	0.519	0.328	0.287	44.122	27.851	24.385
DB-126	1.169	0.780	0.688	80.458	53.684	47.352
DB-127	0.823	0.633	0.532	25.925	19.940	16.759
DB-128	0.548	0.340	0.278	17.736	11.004	8.997
DB-129	1.169	0.780	0.688	90.859	60.625	53.474
DB-130	0.465	0.309	0.234	42.361	28.149	21.317
DB-131	0.765	0.540	0.482	42.259	29.830	26.626
DB-132	0.548	0.340	0.278	54.641	33.901	27.719
DB-133	0.862	0.560	0.509	92.363	60.004	54.539
DB-134	0.765	0.540	0.482	84.959	59.971	53.530
DB-135	0.465	0.309	0.234	46.712	31.041	23.507
DB-136	0.739	0.511	0.458	56.124	38.808	34.783
DB-137	0.739	0.511	0.458	84.764	58.612	52.533
DB-138	0.739	0.511	0.458	51.482	35.599	31.907
DB-139	0.739	0.511	0.458	55.735	38.540	34.542
DB-140	1.169	0.780	0.688	57.216	38.176	33.673
DB-141	1.169	0.780	0.688	101.140	67.484	59.524
DB-142	1.169	0.780	0.688	52.860	35.270	31.110
DB-143	0.465	0.309	0.234	41.065	27.288	20.665
DB-144	0.465	0.309	0.234	48.433	32.185	24.373
DB-145	0.465	0.309	0.234	34.774	23.108	17.499
DB-146	0.465	0.309	0.234	38.723	25.732	19.486
DB-147	0.548	0.340	0.278	45.762	28.392	23.215

**2.1.3 Surface Water Availability.** In contrast to Ground-water availability estimates, data for surface water availability for the 147 watersheds was not readily available for use in this study. A literature review<sup>2,3,4</sup> was undertaken to determine the appropriate methodologies and level of effort necessary to undertake a surface water evaluation. The cited approaches generally rely on multivariate regression equations for regional areas in Pennsylvania and Delaware, or individual stream statistics for streams in New Jersey and are necessarily data-intensive. Consistent with the scope of this study, it was determined that the approach used for estimating ground-water availability could be adapted to provide an estimation of surface-water availability. Therefore, the same set of index streamflow gages were chosen (based on the ground-water methodology report) along with geology (in combination with land-use in the coastal plain) to determine surface-water availability for each of the 147 study watersheds. For more detail on the choice of streamflow gages see the USGS report on Ground-Water Availability.<sup>5</sup>

Daily surface water data were downloaded from the USGS website and analyses were performed to extract statistics that would be representative of surface water availability during periods of low-flow. These statistics were as follows:

- Q<sub>7</sub>10
- 95% flow exceedence value
- September Median Flow minus Q<sub>7</sub>10

The Q<sub>7</sub>10 can be thought of as the lowest stream flow for seven consecutive days that would be expected to occur once in ten years. The 95% flow exceedence value is the flow that is exceeded 95% of the time. The September Median Flow minus the Q<sub>7</sub>10 is calculated by finding the median value for September flows for the period of record and subtracting the Q<sub>7</sub>10.

Q<sub>7</sub>10 analysis was generated from a recurrence interval plot of the Weibull plotting position ( $(\text{Rank}/(n+1))$ ) for each annual 7-day average lowest flow. Flow exceedence values were obtained from a flow duration curve. The statistics were calculated for each of the index gages, and were normalized for contributing drainage area, to generate a figure in terms of million gallons per day per square mile of drainage area. These values were then applied to each watershed based on a GIS analysis of the lithology of the 109 fractured rock watersheds and the predominant surficial geology and land use for the 38 Coastal Plain watersheds. The relationship between the three resulting low-flow statistics for the 49 index stations can be seen graphically in Figure 2.9.

---

<sup>2</sup> Stuckey, Marla H. 2006, Low-flow, base-flow, and mean-flow regression equations for Pennsylvania streams, 2006-5130

<sup>3</sup> Gillespie, B. D.; Schopp, R. 1982, D. *Low-flow characteristics and flow duration of New Jersey streams*

<sup>4</sup> Carpenter, David H.; Hayes, Donald C. 1996, *Low-flow characteristics of streams in Maryland and Delaware*

<sup>5</sup> Sloto, R.A. and Buxton, D.E. 2006, Estimated Ground-Water Availability in the Delaware River Basin, 1997-2000; U.S. Geological Survey Scientific Investigations Report 2006-5125 Version 1.1

These water availability statistics were chosen to provide a range of values representative of low-flows. The statistics are all metrics that have been used in previous or current studies in the Delaware River Basin. For the purposes of this study the Q<sub>7</sub>10 was chosen as an indicator of water availability under low flow conditions; its application will be discussed later in this report. As noted earlier, the approach to quantifying low flow water availability varies among the different states and planning efforts. Studies are ongoing in the Delaware River Basin and elsewhere to better quantify water availability and specifically to account for ecological instream flow needs.

Currently, many of these instream flow needs are being met through releases from the reservoirs within the Basin. The Delaware River Basin has 26 major reservoirs with a total water supply storage capacity of over 414 billion gallons. Table 2.4 shows a listing of these reservoirs, their purpose, location and capacity.

Releases from these reservoirs have helped maintain flow targets during dry conditions and have also provided a means of compensation for consumptive use and any exportation of water in the lower half of the Basin. Releases are made from Blue Marsh Lake and Beltzville Reservoirs, located in the lower basin, to maintain target flows. Portions of the storage in these two Corps' reservoirs have been purchased by the DRBC for this purpose. The storage has been financed through a surface water charging program in which surface users pay for the volume of water withdrawn and consumed. This water charging program will be discussed in more detail in Section 5.0.

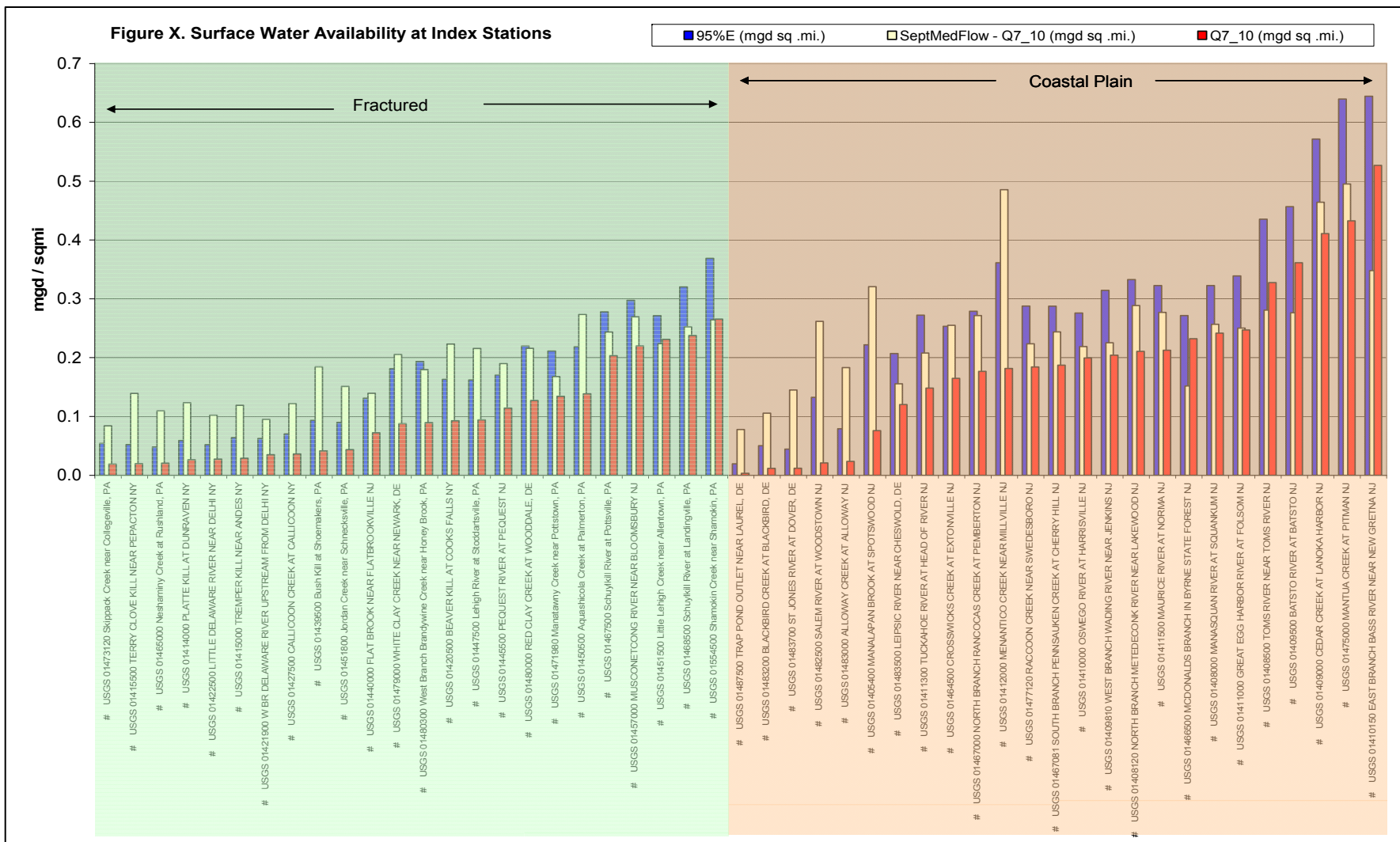

Figure 2.9 Surface Water Availability at Index Stations

Table 2.4  
Major Reservoirs in the Delaware River Basin

NAME	LOCATED ON	STORAGE (MG)	PURPOSE	OWNER
Cannonsville Reservoir	WEST BRANCH DELAWARE RIVER	95706	WS,WSA	New York City Water Supply
Pepacton Reservoir	EAST BRANCH DELAWARE RIVER	140190	WS,WSA	New York City Water Supply
Neversink Reservoir	NEVERSINK RIVER	34941	WS,WSA	New York City Water Supply
Jadwin Reservoir	DYBERRY CREEK (LACKAWAXEN RIVER)	7985	FL	Army Corps of Engineers
Prompton Reservoir	WEST BRANCH LACKAWAXEN RIVER	16849/1115CP	FL	Army Corps of Engineers
Lake Wallenpaupack	WALLENPAUPACK CREEK (LACKAWAXEN RIVER)	35451	P	PPL
Mongaup System		26773	P	Alliance Energy New York
Swinging Bridge	MONGAUP RIVER			
Toronto	BLACK LAKE CREEK (MONGAUP RIVER)			
Cliff Lake	BLACK LAKE CREEK (MONGAUP RIVER)			
F.E. Walter Reservoir	LEHIGH RIVER	36077/652CP	FL,REC	United States Army Corps of Engineers
Penn Forest Reservoir	WILD CREEK (LEHIGH RIVER)	6032	WS	City of Bethlehem
Wild Creek Reservoir	WILD CREEK (LEHIGH RIVER)	3911	WS	City of Bethlehem
Beltzville Reservoir	POHOPOCO CREEK (LEHIGH RIVER)	20792/13443CP	FL,WS,WSA REC	United States Army Corps of Engineers
Merrill Creek Reservoir	MERRILL CREEK (POHATCONG CREEK)	15665	WSA	Merrill Creek Owners Group
Lake Hopatcong	MUSCONETCONG RIVER	7459	WS	
Nockamixon Reservoir	TOHICKON CREEK	21672	WS	PA DCNR
Lake Galena	N. BRANCH NESHAMINY CREEK	1629	WS	Bucks County, PA
Still Creek Reservoir	STILL CREEK (SCHUYLKILL RIVER)	2701	WS	Borough of Tamaqua
Ontelaunee Reservoir	MAIDEN CREEK (SCHUYLKILL RIVER)	3580	WS	Reading Area Water Authority
Blue Marsh Lake	TULPEHOCKEN CREEK (SCHUYLKILL RIVER)	16295	FL,WS,WSA REC	Army Corps of Engineers
Green Lane Reservoir	PERKIOMEN CREEK (SCHUYLKILL RIVER)	4377	WS	Aqua Pennsylvania Water Co
Bradshaw Reservoir	PERKIOMEN CREEK (SCHUYLKILL RIVER)	25	WS,P	Exelon Corporation
Geist (aka Springton) Reservoir	CRUM CREEK	3513	WS	Aqua Pennsylvania Water Co
Marsh Creek Reservoir	MARSH CREEK (CHRISTINA RIVER)	7232	WS,WSA,FL	PA DCNR
Hoopes Reservoir	RED CLAY CREEK (CHRISTINA RIVER)	2000	WS	City of Wilmington, DE
Chambers Lake Near Wagontown	BIRCH RUN (CHRISTINA RIVER)	652	WS, FL, REC	Chester County, PA
Union Lake	MAURICE RIVER	3177	WS	NJ DEP

STORAGE: MG, MILLION GALLONS; CP, CONSERVATION POOL  
PURPOSE: WS, WATER SUPPLY, WSA, WATER-SUPPLY AUGMENTATION; FL, FLOOD STORAGE; P, HYDROPOWER; REC, RECREATION



**2.1.4 Affects of Climate Variability.** Once water availability was calculated, the affects of climate variability were added to the equation. A literature review was conducted to review the current state of knowledge on climate variability in the Delaware River Basin. There was little consensus among the articles as to what degree future climate variability will impact streamflow and groundwater in the region; however, several articles agreed on some general trends in climate variability. Where the articles disagreed on was the magnitudes of the climate variability trends. Also, most of the articles projected longer-term climate variability trends well beyond the year 2030 with very little information given up to year 2030.

The current state of knowledge is heavily dependent upon the results of computer climate models and assumptions made regarding future trends in emissions. Different climate models and emission scenarios give different results, and there is no consensus as to which climate model or emission scenario is more likely.

During the literature review, articles were found that summarized results for the Mid Atlantic region from several different climate models and emission scenarios. Many of the articles predicted earlier peaks in streamflow in the Spring and later peaks in the Fall. As for the low-flow period in the Summer, the current state of knowledge is suggesting that its period could be extended but this probably would not be observable until the end of the century and not by the year 2030. All of these conclusions are dependent upon future trends in emissions. Lower emission scenarios produce less dramatic results in the computer models than higher emission scenarios.

Generally speaking, some other trends that many articles agreed upon were:

- Minimum winter temperatures are likely to increase slightly in the region.
- Annual mean precipitation is likely to increase.
- Snow season length and depth is likely to decrease.

Only one reviewed article quantified by how much if at all how all of these climate variability trends would impact the Q<sub>7</sub>10 low-flow quantity which was used to calculate water availability in this Study. The Northeast Climate Impacts Assessment (NECIA) team published a report in July 2007 called “Confronting Climate Change in U.S Northeast: Science Impacts, and Solutions”. In that report, the authors state that by the end of the century under a high emission scenario they examined, the streamflow during the lowest week of the year was projected to drop 10%.

It can be argued that the change in seasonality of streamflow probably would have a very minimal impact if any at all on the Q<sub>7</sub>10 along with slightly wetter, less snow winters. For purposes of this Study, it was assumed that projections of available water supply in the Year 2030 would be reduced by 5%. This is a conservative assumption based upon the literature review of the current state of knowledge on climate variability. To reduce Q<sub>7</sub>10 by more than 5% is probably over-estimating the potential impacts of climate variability by the Year 2030.

Besides available streamflow in the Year 2030, climate variability can impact other areas in water supply that were incorporated in the analysis such as groundwater baseflows in New Jersey and Delaware, which rely on ground water sources for their water supply. It was assumed that the 25-yr baseflow which was used in the analysis would also be reduced by 5% for the Year 2030.

Reservoir storage capacities at reservoirs identified as potential alternative sources for water supply were also adjusted to account for climate variability. The average 120-day yields used in the analysis was also reduced by 5%.

Climate variability could also potentially impact Delaware River salinity. In April 2007 a re-evaluation of the salinity numerical model for the Delaware River was conducted as part of the Delaware Deepening Project. The re-evaluation examined what the salinity impacts on the Delaware River would be for fresh water flows from the drought of the 1960's. The re-evaluation also considered what would happen if the Delaware River navigation channel was deepened five feet, if consumptive use increased to projected levels for the year 2040, and if sea-level rose 0.547 feet and 0.492 feet at the Delaware and Chesapeake Bay boundaries of the model respectively. These sea-level values represent potential sea-level conditions in the year 2040 based upon the historical information that mean sea-level has increased 1.273 feet over the past 100 years in the region. These three scenarios were examined independently and if they were all to occur together. The model showed that when all the scenarios were combined together that the chlorinity value at river mile 98 increased to 140 ppm.

DRBC regulates flows at Trenton, NJ based upon a running 7- and 30-day average chlorinities at river mile 98. The present water quality standards supported by DRBC call for 30-day average chlorinity at river mile 98 to be below 180 ppm, however, there have been discussions that the 30-day chlorinity standard should be more restrictive and lowered to 150 ppm chlorinity.

The increased salinity level of 140 ppm as produced by the model is still below the current 30-day standard of 180 ppm and the more restrictive 150 ppm standard being discussed as well.

## 2.2 WATER DEMAND

**2.2.1 Existing Conditions.** As can be seen in Figure 2.10, over 8.5 billion gallons of water per day are withdrawn from the Basin (as of 2003) with 92% of those withdrawals coming from surface water and 8% coming from ground water. Figure 2.10 shows that the greatest volume of water use (over 70%) is for thermoelectric power generation in the year 2003.

Although this sector is the largest user of water, it is comprised of a relatively small number of individual facilities. And although some of these are located on the mainstem Delaware River and its tributaries, the majority are located in the estuary where withdrawals have limited impact on downstream users.

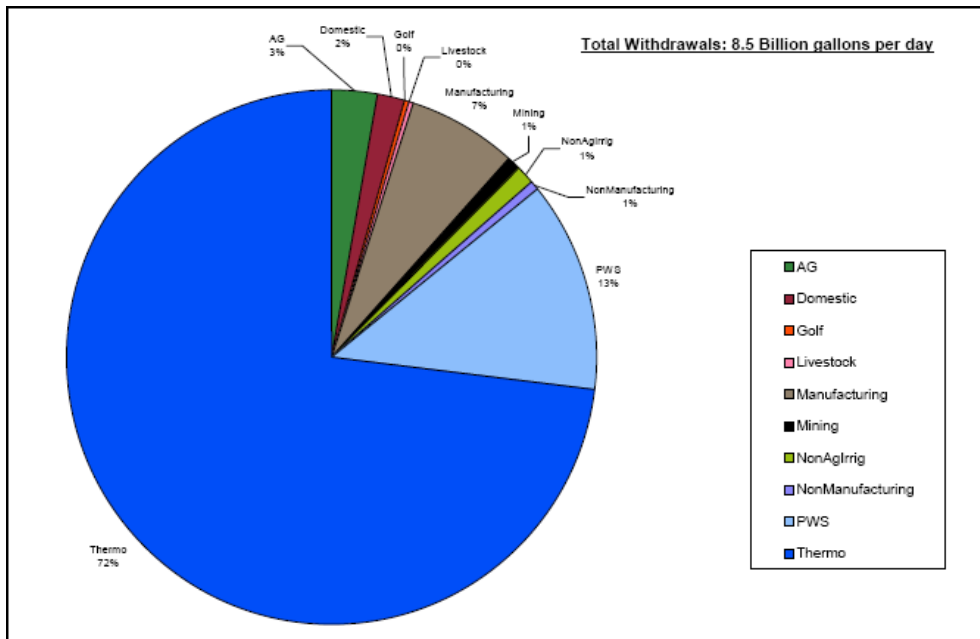

Figure 2.10 Water Withdrawals in the Delaware River Basin (2003)

**2.2.2 Forecasting Future Demand.** Understanding future water demands is vital in ensuring an adequate and reliable water supply for all users of the resource. Water demand forecasting methodologies vary from the simplistic (such as extrapolation of past trends) to complex, sector-specific, multivariate models which attempt to use multiple explanatory variables to forecast future demand. No single approach fits all applications, and the more complex the model, the more data intensive it becomes. In defining the applicable methodology for this project, an assessment of recent water demand forecasting efforts in each of the Basin states was undertaken. At the same time, an assessment of the available data and their accuracy was also conducted.

Outlined below is a brief summary of each of the Basin states' approaches to water demand forecasting.

**Delaware.** In response to the drought of 1999, a Water Supply Task Force presented a number of options for increasing supply in Northern New Castle County, Delaware. A Water Supply Coordinating Council was created, consisting of public agencies, water purveyors, and the public, to work cooperatively to develop estimates of future water demand and implement the selected water supply options. The work focused on enhancing public water supplies and relied upon future population as a driver of water demand. Agricultural irrigation demands were also evaluated, with future water demands based upon trends in agricultural land. Water use records from water users are reported to the Delaware Department of Natural Resources and Environmental Control (DNREC). Records for the year 2003 were available and used in this study; a limited amount of QA/QC work was required to address known problems with the reported data. These issues were resolved by working with DNREC staff.

**New Jersey.** New Jersey has developed water demand projections as part of its State-wide Water Plan. A focus has been placed on the growth in the public water supply sector; agricultural demand has been forecast based on trend extrapolation, no industrial or commercial forecasts (for those industries with their own sources of supply) have been developed. The primary driver of future demand for public supply is population change, based on forecasts developed by Metropolitan Planning Organizations at the municipal level. A core assumption for existing and future water use is a demand of 100 gallons per capita per day. Water use records from water users are reported to the New Jersey Department of Environmental Protection (NJDEP). Records were available for 2003 and were used in this study following a significant amount of QA/QC.

**New York.** No statewide water supply planning efforts, including water demand forecasting, are currently underway in New York. Water use data were obtained from DRBC's own water use databases and other sources such as the EPA Envirofacts database. Some of these data reflected 2001 water use instead of the target base year of 2003, but as the total withdrawal from water users (not including the export to New York City) in the New York portion of the Basin is small (less than 0.5% of total basin water use) this was not significant.

**Pennsylvania.** Pennsylvania's Act 220 Water Resources legislation calls for the development of a new State Water Plan. As part of this process, DRBC worked in conjunction with the Pennsylvania Department of Environmental Protection (PADEP) and the consulting firm CDM, to develop methodologies for projecting water demands for a number of water use sectors. This work provides the basis for several of the methodologies used in this study. The forecasting methodologies developed for the State Water Plan process typically follow the same general approach for each water use sector, which is to identify a key water use factor (e.g., per employee water use) and its corresponding "driver of demand" (e.g., forecasted number of employees). Each sector was studied separately to identify the most applicable factors and drivers. Water use records from water users are reported to the Pennsylvania Department of Environmental Protection (PADEP) and were available for the year 2003. As part of its ongoing support

of the State Water Plan, the DRBC has been working with PADEP to improve data reliability; as such little additional QA/QC effort was required.

**2.2.2.1 Methodology Used For Watershed Analysis.** Following a review of the methods employed and data available in each state, it was determined that a disaggregated demand forecasting methodology should be applied. This methodology calls for each water use sector to be forecast separately, using drivers of demand most applicable to that sector. Although obtaining reliable and current water use data is still an ongoing challenge in the Delaware River Basin, the data available has improved significantly in recent years. For the purposes of this study, water user records for 2003 were deemed to be reliable for estimates of current water use and as a platform from which to project future water use.

For any given sector (e.g., public water supply), identifying a single methodology to apply Basin-wide presents a number of challenges; while it is advantageous for reasons of consistency to apply a single methodology across all four states, the differences in data quality and data availability between the states would lead to a “lowest common denominator” forecast methodology and would ultimately result in less credible forecasts. Therefore, methodologies have been selected that take advantage of the different types of data available in each state. These data requirements and key drivers of demand used for this study are shown in Table 2.5.

**2.2.2.1.1 Population Growth.** As can be seen in Table 2.5, one of the key drivers in calculating demand for public water supply is population growth. This makes it an integral component when projecting future water demand. The boundary of the Delaware River Basin contains portions of Delaware, New Jersey, New York and Pennsylvania. Numerous population projections by state agencies and research organizations within the Basin were reviewed for use in this study. As each agency or research publication pertained to a particular state, uniformity of projection methods across the entire basin was not possible. The best available projection figures were selected based on the needs of this project.

The most applicable population figures were allocated to the 147 watersheds using GIS. To minimize the assumptions that arise when allocating figures across a geographic boundary, the finest geographic boundaries available were selected. Population projections for New Jersey and Pennsylvania were found at the municipal level. Delaware had county level population projections which also included figures for major cities, three of which are found within the basin. Projections for the New York portion of the basin were only available at the county level. However, due to the lack of major cities and the overall distribution of the population in this region of the basin, these figures are believed adequate for the purposes of this study. Final population figures broken down to sub-basin can be found in Technical Appendix A.

**Table 2.5**  
**Summary of Data Requirements and Key Water Demand Drivers for Each Water Use Sector**

	Sector	State	Sub-components	Data Required	Key Demand Drivers	
Water Purveyor		PA	Residential	PWS Water Use records		
				Water Purveyor service areas (GIS)		
				Allocation of use by end-user types		
				Census data	Population projections (developed by each state)	
			Non-Residential (Manufacturing)	Employment data (Manufacturing)	Manufacturing employment projections	
		Non-Residential (Non-manufacturing)	Employment data (Non-manufacturing)	Non-manufacturing employment projections		
		NJ, DE			PWS Water Use records	
					Water Purveyor service areas (GIS)	
					Census data	Population projections (developed by each state)
		NY			PWS Water Use records	
Census data	Population projections (developed by each state)					
Self-Supplied	Domestic	ALL		Domestic use estimates adapted from USGS report <sup>5</sup>	Population projections (developed by each state)	
	Industry	NJ, PA		Water Use records Employment data (Manufacturing)	Manufacturing employment projections	
		DE		Water Use records Employment data (Manufacturing)	Trend extrapolation of manufacturing employment data	
		NY		Water Use records	Held constant	
	Commercial (inc. Golf & Non Ag. Irrigation)	NJ, PA		Water Use records Employment data (Non-Manufacturing)	Non-manufacturing employment projections	
		DE		Water Use records Employment data (Manufacturing)	Trend extrapolation of manufacturing employment data	

<sup>5</sup> Estimated Ground-Water Availability for the Delaware River Basin 1997-2000

**Table 2.5**  
**Summary of Data Requirements and Key Water Demand Drivers for Each Water Use Sector**

	Sector	State	Sub-components	Data Required	Key Demand Drivers
Self-Supplied		NY		Water Use records	Held constant
	Thermoelectric	ALL		Water Use records DoE Energy Information Administration Data Consumptive Use info - (site specific) DRBC dockets	Trend extrapolation: water use 1994 - 2003 Rate of growth consistent with EIA forecasts of MW demand growth for Mid-Atlantic Region
	Hydroelectric	ALL		Water Use records	Held constant
	Mining	PA, NJ <sup>6</sup>		Water Use records Consumptive Use info - (site specific for biggest uses) Employment data (Mining)	Mining employment projections
		DE, NY		Water Use records Consumptive Use info - (site specific for biggest uses)	Held constant
	Agriculture	ALL	Crops	Irrigated acreage (USDA Ag. Census) Water withdrawals (USDA Ag. Census) Crop type distribution (USDA Ag. Census) Water Use coefficients (Ag. Census)	USDA projections of water withdrawals
		ALL	Livestock	Head count by animal type (USDA Ag. Census) Water use by animal type (PSU)	USDA projections

**Definitions:** Self-supplied: Water users responsible for their own sources of supply, e.g., a residential dwelling with its own well, or an industry with its own water intake  
**Demand Drivers:** An explanatory variable that is primarily responsible for changes in demand, e.g., population projections are the primary driver for changes in residential water demand

<sup>6</sup> Employment projections were used, where available, for counties in New Jersey; elsewhere held constant

**2.2.2.1.2 Water Conservation.** Another key driver for calculating water demand is the inclusion of existing water conservation programs. The Delaware River Basin Commission has a well-established and comprehensive water conservation program which has for many years provided water resources protection and improved drought preparedness and response. Water conservation has become an integral component of the Commission’s strategy to manage water supplies throughout the Basin and includes both regulatory and educational initiatives.

It is the policy of the Commission to require maximum feasible efficiency in the use of water on the part of water users throughout the Basin. The Commission works towards this through its regulatory program. Under Section 3.8 entitled ‘Referral and Review’ of the Delaware River Basin Compact, the Commission is charged with reviewing and approving all projects having a substantial effect on the water resources of the Delaware River Basin. The Commission’s regulatory program covers the following general areas which are discussed in more detail in Technical Appendix A:

- Source and Service metering
- Water loss, leak detection and repair
- Water conservation performance standards for plumbing fixtures and fittings
- Conservation oriented pricing structures; and
- Requirements for water conservation plans and water user education.

Based on these current conservation practices, DRBC staff knowledge and a review of a key water conservation publication<sup>7</sup>, a set of “baseline” water conservation assumptions was developed for use in the water demand projection model. The set of baseline assumptions is intended to reflect ongoing water conservation efforts in the Delaware River Basin and the general trend is that conservation efforts and impacts are likely to increase over time. The baseline scenario can be thought of as a projection of trends in water conservation. To some degree, the impact of water conservation is likely to offset some of the additional water demand which may occur due to the impacts of other factors (e.g., population increases). Estimating future water use reductions through conservation is a complex task. The assumptions used in this investigation provide a starting point and can be refined by future studies.

In watersheds that indicate a significant level of stress, additional water conservation efforts may be feasible and may help reduce demand and improve the supply-demand balance.

Table 2.6 shows the baseline water conservation assumptions developed for use in the water demand projection model.

---

<sup>7</sup> Vickers, A.L. Handbook of Water Use and Conservation, 2001. Water Plow Press.



Table 2.6  
Water Conservation Assumptions by Sector

Sector	2005	2010	2015	2020	2025	2030	Tot. Consv. Impact
Public Water Supply (PWS)	0%	1%	2%	3%	4%	5%	14.2%
Non-Manufacturing	0%	1%	2%	2%	2%	2%	8.7%
Manufacturing	0%	1%	2%	2%	2%	2%	8.7%
Thermoelectric	0%	0%	0%	0%	0%	0%	0.0%
Hydroelectric	0%	0%	0%	0%	0%	0%	0.0%
Mining	0%	0%	0%	0%	0%	0%	0.0%
Agriculture	0%	0%	2%	4%	5%	5%	15.1%
Livestock	0%	0%	1%	1%	1%	1%	3.9%
Non-Ag. Irrigation	0%	1%	1%	2%	2%	2%	7.8%
Golf	0%	1%	1%	2%	2%	3%	8.7%
Self-Supplied Residential	0%	1%	1%	1%	1%	1%	4.9%

### 2.2.3 Results of Water Demand Forecasting and Water Availability Analysis

Figure 2.11 shows the anticipated change in peak month water demand for the 147 watersheds between the base year 2003 and the end of the projection period 2030 without factoring in the impact of water conservation. Figure 2.12 shows the change including the impacts of conservation. It should be noted that these two figures show no indication of water availability; only changes in demand based on the drivers of water demand explained in Table 2.5. This is useful for understanding where water demand increases and other associated water resource issues are likely to occur in the future. All subsequent analysis will be performed using the demand changes that include the impact of water conservation.

# Projected Change in Peak Month Water Demand 2003-2030

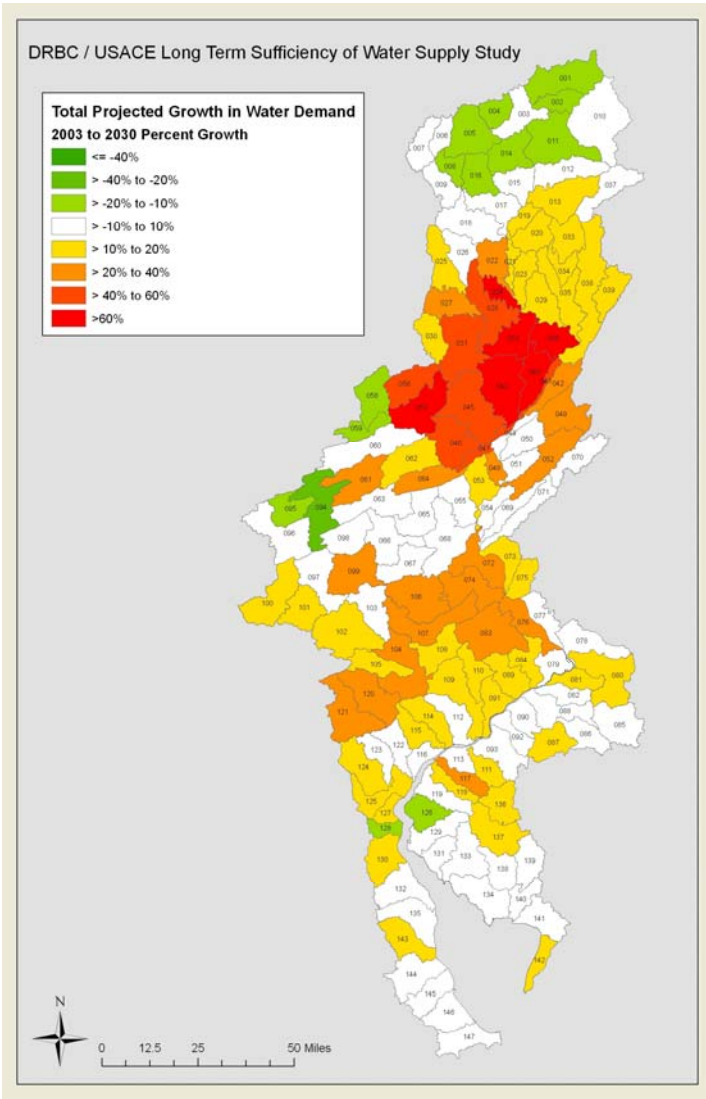

Figure 2.11 Excluding Water Conservation

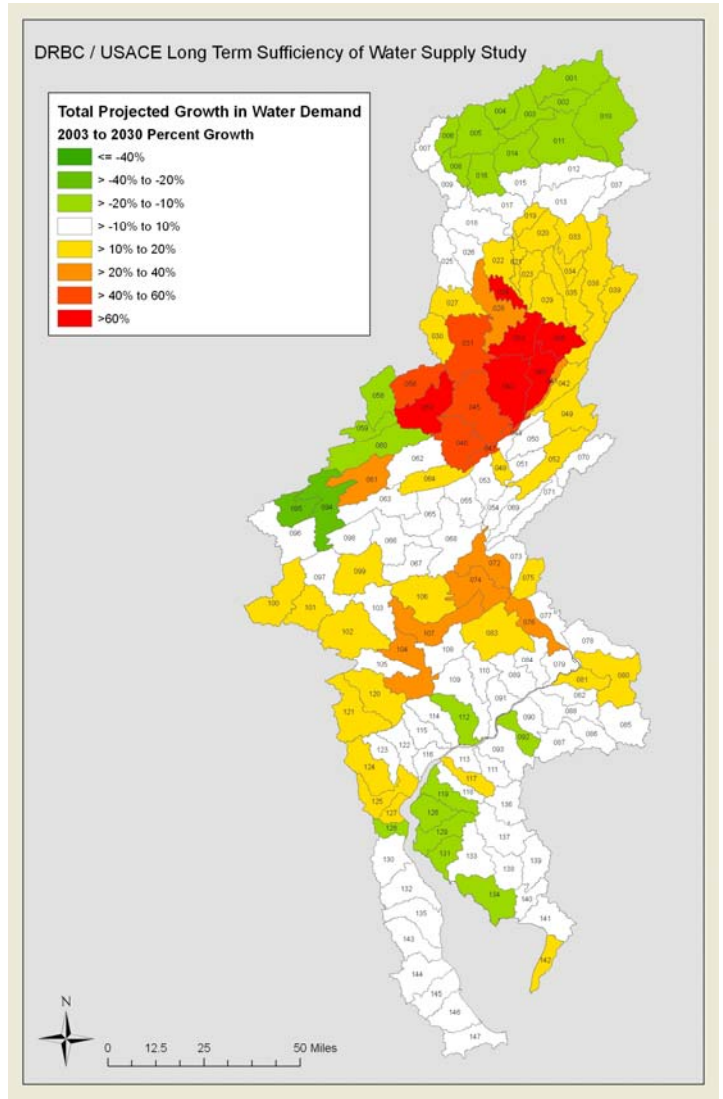

Figure 2.12 Including Water Conservation

Figures 2.13 and 2.14 show the projected trend in water demand, including the impact of baseline water conservation assumptions, which are used in the water supply deficiency analysis. It shows that thermoelectric power demand accounts for the majority of water withdrawals; it also shows that the majority of the increase in demand is attributable to the projected growth in the thermoelectric sector. It is evident that the projected demand for the Delaware River Basin is very sensitive to assumptions about future growth in the thermoelectric sector. The demand projections used in this study were derived by extrapolation of past trends in water demand by this sector in the Delaware River basin over the period 1994 to 2003. This growth trend is consistent with an independent study by the U.S. Department of Energy, Energy Information Administration which projects future growth in demand for megawatts of energy. The growth projections used were for the Mid Atlantic region which includes the Delaware River Basin. Since deregulation of the power generation industry, predicting the location of future energy generation has become more complex. For the purposes of this study future growth was assumed to be accommodated at existing facilities. Further study is recommended to better understand the extent and possible location of additional power generation in the Delaware River Basin, as it has the potential to significantly impact water availability.

In order to see more clearly, the trends in other sectors, Figure 2.14 shows the same data as Figure 2.13, but excludes the thermoelectric sector. It is notable that without the inclusion of thermoelectric demands, water demand from the other sectors is projected to decrease by 8.5% over the projected period.

Figure 2.15 and 2.16 show an assessment of peak month ground-water availability for the 147 watersheds. Figure 2.15 shows the base year assessment (2003) and Figure 2.16 shows the projected 2030 assessment. The assessment compares the sum of ground-water withdrawals for the watershed against the 1-in-25 year baseflow recurrence interval. The assessment is consistent with known areas that are sensitive to ground-water withdrawals, namely the Ground Water Protected Area (GWPA) in southeastern Pennsylvania and the New Jersey Water Supply Critical Area 2.

Figures 2.17 and 2.18 show an assessment of peak month surface water availability for the 147 watersheds. Figure 2.17 shows the base year assessment (2003) and Figure 2.18 shows the projected 2030 assessment. The assessment compares the sum of consumptive surface water withdrawals for the watershed against the  $Q_710$  value computed for the mouth of the watershed. Consumptive use is used rather than total withdrawals recognizing that surface water is often withdrawn and discharged multiple times (i.e., the discharge from upstream users add to the flow available for downstream users).

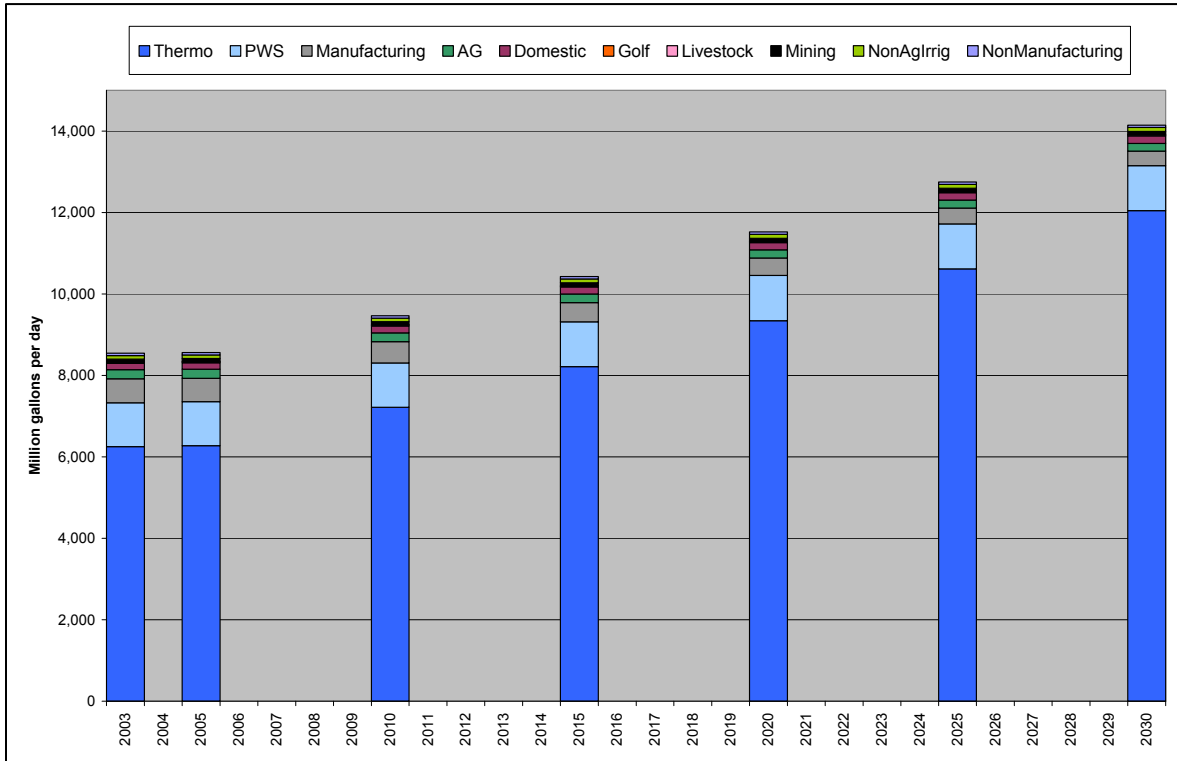

Figure 2.13 Projected Trend in Peak Month Water Withdrawals, by sector: 2003 – 2030

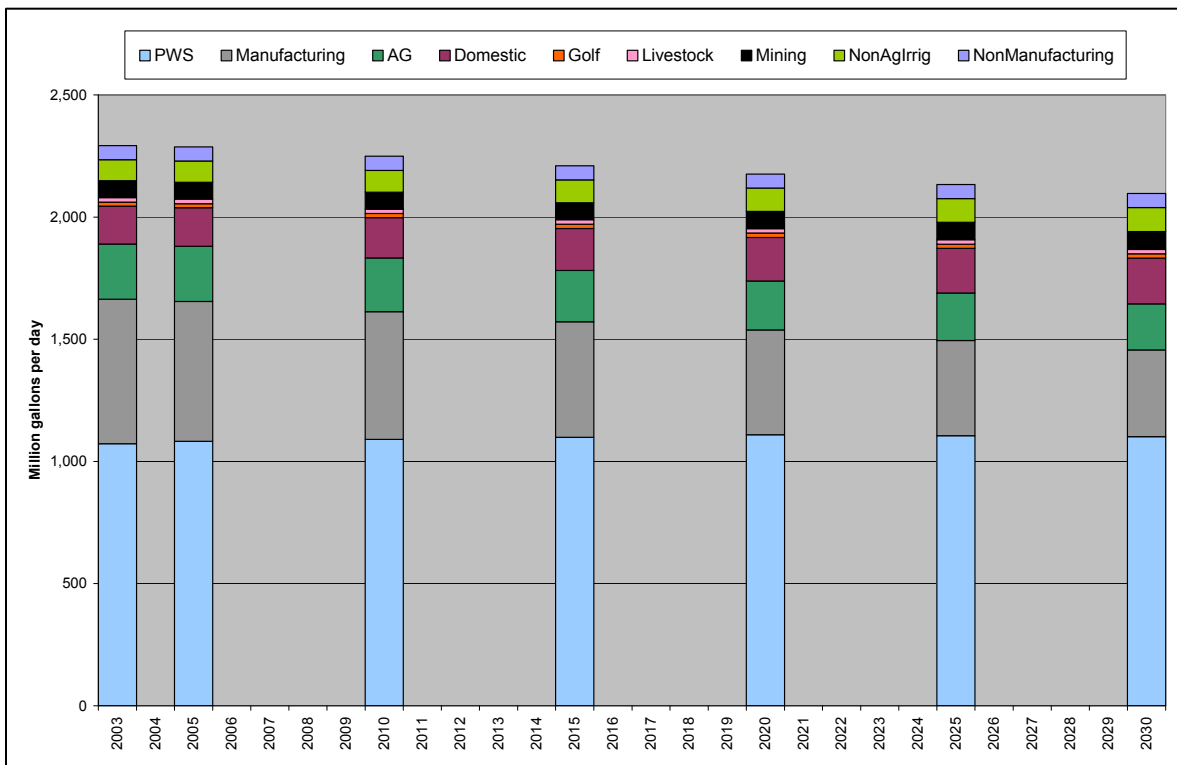

Figure 2.14 Projected Trend in Peak Month Water Withdrawals (excluding Thermolectric), by sector: 2003 – 2030

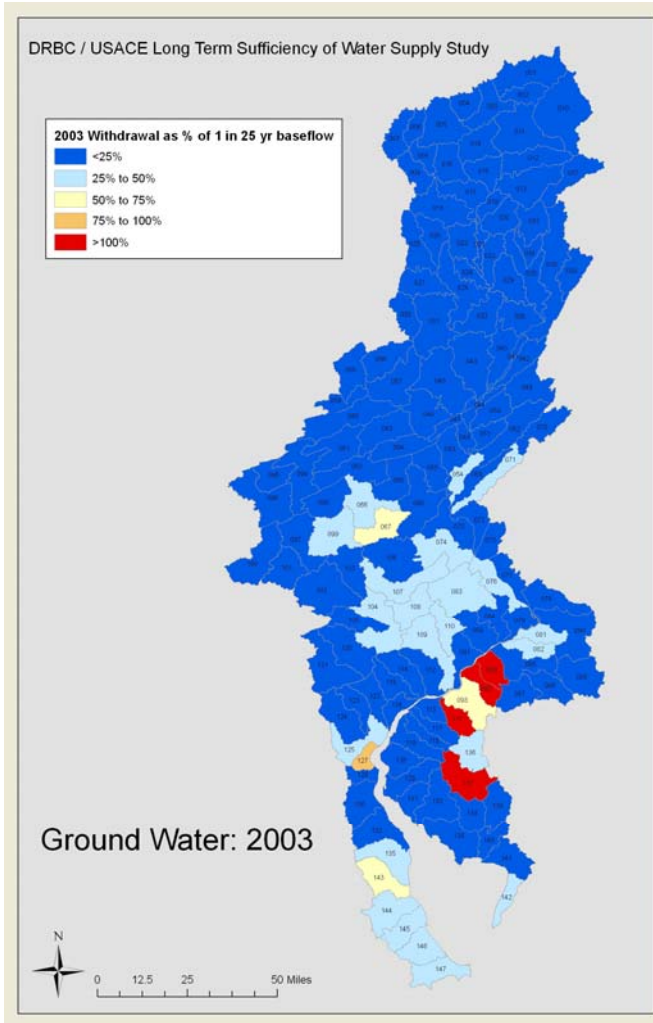

Figure 2.15 Year 2003

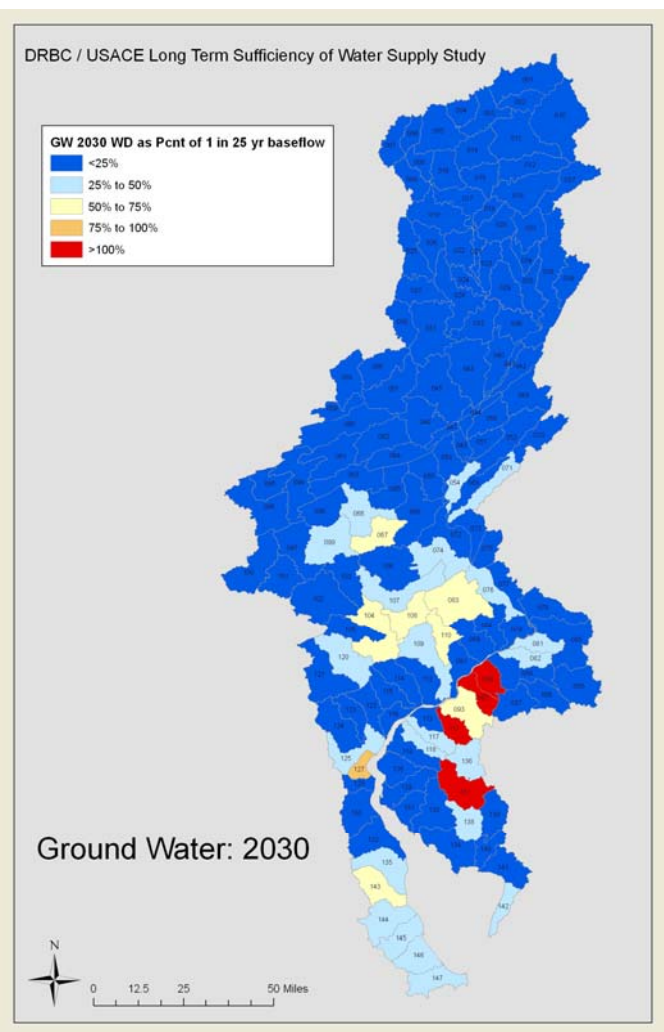

Figure 2.16 Year 2030

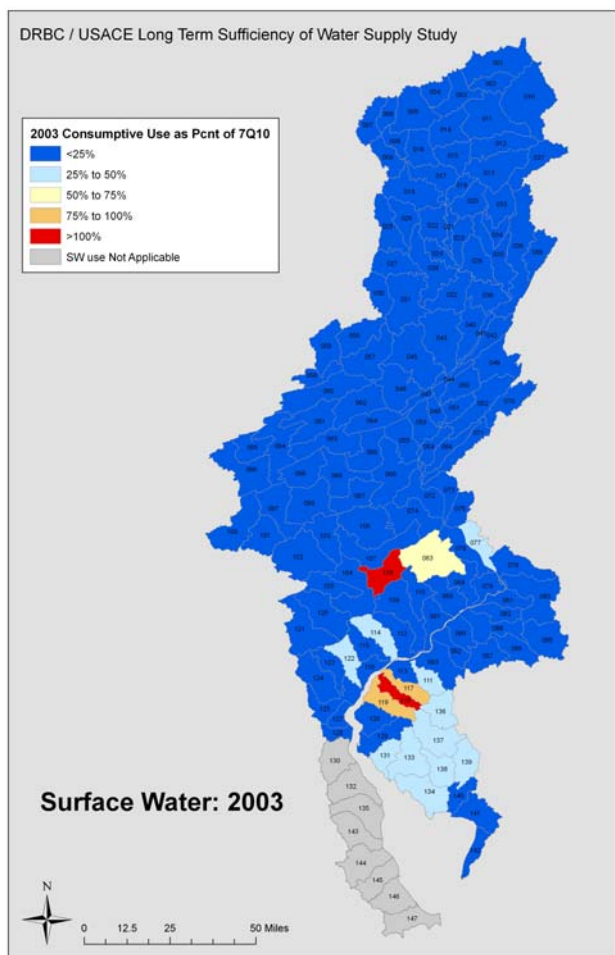

Figure 2.17 Year 2003

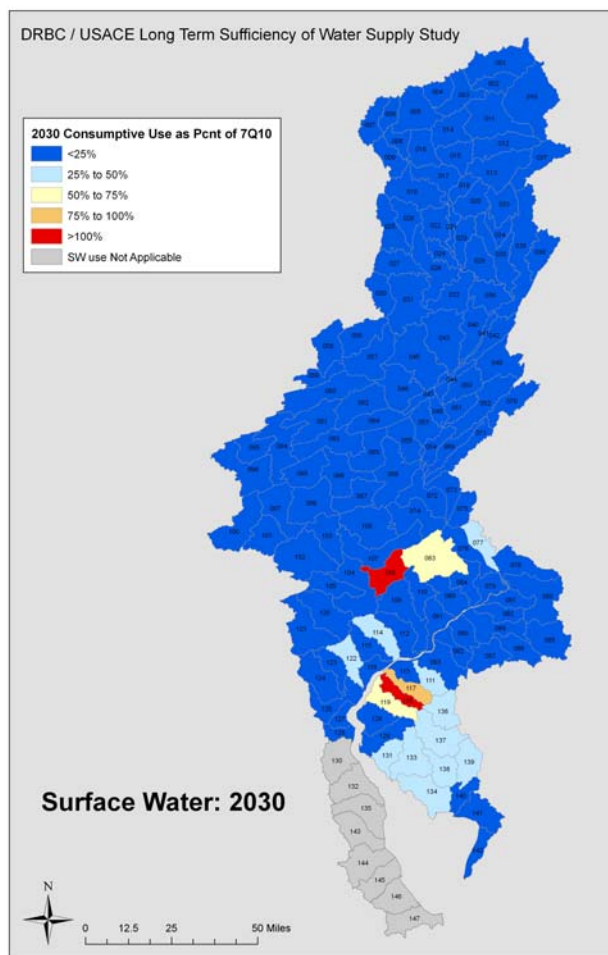

Figure 2.18 Year 2030

\* Surface water use was not applicable in certain coastal watersheds in Delaware; these watersheds were excluded from the surface water assessment.

**2.2.4 Sensitivity Analysis.** In order to deal with the inherent uncertainty in water demand projections it is often useful to use a scenario-based approach. This can typically involve the use of varying growth factors or other drivers of demand. This is often a useful approach in any forecasting exercise and is one way to test the sensitivity of a water demand projection to its underlying assumptions. In addition to helping manage uncertainty, scenarios are also useful from a water resources management perspective as they can be used to determine not only the most likely (or forecast) future demand, but also what is required to reach a desired future demand. For example, if the available water supply is limited, alternative scenarios can illustrate what steps may be needed to constrain water demand; this may mean limiting opportunities for additional (new) demand, or requiring more efficient use by existing water users or adding new sources of supply. Policy decisions can then be made with the objective of reaching the most desirable outcome.

The water demand projection tool developed for the purposes of this study has been designed to accommodate the modeling of alternative scenarios. Some examples of factors that can be adjusted in the projection model include water conservation assumptions, consumptive use estimates and average versus seasonal demands. The scope for adjusting underlying assumptions in the projection model is extensive; within the scope of this study, peak month estimates of water demand were used as these are a more appropriate measure than annual average demands against which to compare water availability at times of low flow (which typically coincides with periods of increased water demand). The sensitivity of the demand projections to water conservation efforts was also examined and results are provided below. For the purposes of comparison to water availability the water demand numbers used include an estimate of the impacts of water conservation, recognizing that water conservation is a well-established practice and is likely to result in increased water efficiency as more efficient technologies replace less efficient ones. Further studies could build on this approach to investigate a range of alternative scenarios varying multiple parameters.

#### **2.2.5 Summary of Total Withdrawals and Consumptive Use by Watershed.**

Tables 2.7 and 2.8 show a summary of current and future water use, aggregated to the watershed scale, for the eight watersheds identified for further study. Table 2.7 shows Annual MGD for total withdrawals and consumptive use for ground and surface water, while Table 2.8 shows Peak MGD (July) for total withdrawals and consumptive use for ground and surface water. (Complete tables are displayed in Technical Appendix A)

Table 2.7  
Current and Future Water Use, Aggregated to the Watershed Scale

Basin_ID	SourceType	Total Withdrawals: Annual MGD							Consumptive Use: Annual MGD						
		2003	2005	2010	2015	2020	2025	2030	2003	2005	2010	2015	2020	2025	2030
DB-090	GW	21.004	21.198	20.976	20.762	20.651	20.341	20.078	2.222	2.241	2.217	2.192	2.178	2.144	2.116
DB-090	SW	0.542	0.540	0.528	0.507	0.488	0.472	0.462	0.487	0.486	0.475	0.457	0.439	0.425	0.416
DB-092	GW	18.399	18.344	17.975	17.575	17.253	16.829	16.503	1.925	1.919	1.880	1.838	1.803	1.758	1.724
DB-092	SW	0.712	0.707	0.686	0.657	0.629	0.605	0.583	0.350	0.348	0.340	0.326	0.313	0.302	0.294
DB-108	GW	6.025	6.129	6.327	6.454	6.580	6.582	6.586	0.635	0.645	0.665	0.677	0.690	0.689	0.689
DB-108	SW	15.290	15.476	15.799	16.029	16.272	16.465	16.675	1.597	1.616	1.650	1.673	1.696	1.715	1.734
DB-111	GW	11.665	11.806	12.051	12.245	12.467	12.590	12.860	4.594	4.654	4.763	4.857	4.945	4.977	5.044
DB-111	SW	1.273	1.273	1.256	1.220	1.185	1.159	1.143	0.893	0.889	0.870	0.834	0.800	0.775	0.757
DB-117	GW	2.551	2.638	2.863	3.070	3.253	3.597	3.759	0.430	0.440	0.462	0.480	0.496	0.531	0.548
DB-117	SW	0.940	0.936	0.914	0.876	0.838	0.811	0.792	0.846	0.842	0.823	0.788	0.754	0.730	0.713
DB-118	GW	1.978	2.037	2.176	2.356	2.495	2.623	2.765	0.399	0.406	0.419	0.434	0.445	0.456	0.470
DB-118	SW	1.097	1.092	1.068	1.026	0.984	0.953	0.932	0.987	0.983	0.962	0.923	0.885	0.858	0.839
DB-127	GW	11.308	11.367	11.401	11.411	11.422	11.429	11.431	1.057	1.067	1.081	1.092	1.102	1.110	1.117
DB-127	SW	0.829	0.796	0.713	0.632	0.561	0.497	0.441	0.094	0.090	0.082	0.073	0.065	0.059	0.053
DB-137	GW	35.702	36.112	36.877	38.428	39.143	39.684	40.369	22.954	23.242	23.822	24.926	25.402	25.725	26.174
DB-137	SW	2.982	2.968	2.897	2.774	2.653	2.563	2.502	2.684	2.671	2.607	2.496	2.388	2.307	2.252

\*All figures are annual averages (Million gallons/per day), and are listed by source type, ground water (GW) and surface water (SW).



Table 2.8  
Current and Future Water Use, Aggregated to the Watershed Scale

Basin_ID	SourceType	Total Withdrawals: Peak MGD (July)							Consumptive Use: Peak MGD (July)						
		2003	2005	2010	2015	2020	2025	2030	2003	2005	2010	2015	2020	2025	2030
DB-090	GW	27.198	27.435	27.167	26.923	26.811	26.452	26.192	3.214	3.239	3.203	3.165	3.142	3.095	3.060
DB-090	SW	2.110	2.104	2.055	1.973	1.895	1.834	1.792	1.899	1.893	1.850	1.776	1.705	1.651	1.613
DB-092	GW	24.380	24.302	23.823	23.266	22.818	22.237	21.771	2.774	2.766	2.711	2.645	2.590	2.522	2.467
DB-092	SW	1.891	1.879	1.827	1.749	1.674	1.611	1.560	1.206	1.200	1.171	1.122	1.075	1.038	1.010
DB-108	GW	7.179	7.308	7.558	7.723	7.886	7.892	7.899	0.794	0.807	0.831	0.845	0.860	0.859	0.857
DB-108	SW	19.704	19.943	20.359	20.652	20.961	21.203	21.465	2.248	2.275	2.321	2.351	2.381	2.400	2.421
DB-111	GW	19.796	20.023	20.409	20.692	21.013	21.178	21.645	8.191	8.292	8.466	8.609	8.740	8.780	8.889
DB-111	SW	4.131	4.117	4.033	3.878	3.728	3.616	3.540	3.486	3.471	3.391	3.248	3.111	3.008	2.937
DB-117	GW	4.098	4.228	4.564	4.868	5.139	5.680	5.925	1.087	1.101	1.132	1.151	1.165	1.220	1.242
DB-117	SW	3.798	3.783	3.701	3.552	3.407	3.307	3.236	3.418	3.404	3.331	3.197	3.066	2.976	2.913
DB-118	GW	3.611	3.705	3.921	4.196	4.400	4.591	4.805	1.100	1.109	1.121	1.129	1.129	1.133	1.147
DB-118	SW	4.386	4.368	4.273	4.103	3.936	3.812	3.731	3.947	3.931	3.846	3.693	3.542	3.431	3.358
DB-127	GW	237.552	241.466	247.930	253.478	257.830	260.960	262.865	23.794	24.190	24.845	25.406	25.846	26.164	26.360
DB-127	SW	1.444	1.388	1.246	1.106	0.983	0.874	0.778	0.186	0.180	0.165	0.149	0.135	0.123	0.112
DB-137	GW	83.778	84.795	86.772	90.618	92.340	93.583	95.229	63.057	63.844	65.435	68.448	69.727	70.586	71.802
DB-137	SW	11.856	11.799	11.515	11.018	10.536	10.176	9.930	10.671	10.619	10.363	9.916	9.482	9.158	8.937

\*All figures are peak averages using the month of July (Million gallons/per day), and are listed by source type, ground water (GW) and surface water (SW).

**2.2.2.2 River Analysis for Surface Water Withdrawals.** In addition to the surface water withdrawals analysis performed on the 147 watersheds an additional analysis was undertaken. Within the Delaware River Basin there are 91 surface water intakes that withdraw water from the Delaware, Lehigh or Schuylkill rivers. These withdrawal points are affected by all upstream water uses and sizeable drainage areas and thus, applying them to any one of the 147 watershed delineations of this study was not appropriate. Consequently a different approach was developed for determining surface water supply availability for water withdrawals located on the three largest rivers in the basin.

The  $Q_{710}$  was chosen as the statistic representative of surface water availability during periods of low-flow. The first step in the river analysis was to select a stream gage on each of the three big rivers for use as a reference gage. Each gage was selected based on a robust period of record. The following USGS stream gages were chosen:

- Delaware River at Trenton, NJ # 01463500 Period of Record: 1980-2006
- Lehigh River at Glendon, PA # 01454700 Period of Record: 1967-2006
- Schuylkill River at Pottstown, PA # 01472000 Period of Record: 1928-2006

For each reference gage, all upstream consumptive use associated with surface water withdrawals located on the given river was added to the  $Q_{710}$  recorded at the gage. This provided an estimate of “natural”  $Q_{710}$  at the reference gage. This number was then divided by the total drainage area to the gage and the resulting ratio (MGD/Square Mile) was applied to the drainage area of each surface water withdrawal point along that river (calculated based on a GIS analysis), providing an estimation of “natural”  $Q_{710}$  at each surface water withdrawal point along the big rivers. In the final step of the analysis, the natural  $Q_{710}$  value was modified for each withdrawal point to represent the water available at that point under  $Q_{710}$  conditions, taking into account the activity of upstream users. The adjustment is made by subtracting all upstream consumptive use from the natural  $Q_{710}$  value; this adjustment reflects the fact that upstream consumptive use removes water from the river, making it unavailable for downstream users. To create an indicator of availability, the withdrawal value at each point is expressed as a percentage of the modified  $Q_{710}$  value.

Of the 91 surface water intakes located on the three major rivers of the Delaware River Basin, the above analysis was performed on 71. Twenty surface water withdrawals were not analyzed because they are located in the estuary portion of the basin, downstream of the mouth of the Schuylkill River. Demand estimates and forecasts were conducted for these points, but water availability analysis was not. It was recognized that extrapolation of a  $Q_{710}$  statistic to a tidal region was not applicable. Surface water withdrawals in these regions are already capable of dealing with issues of salinity and thus water supply was not considered a primary concern in this portion of the estuary.

The results of this analysis are shown in Figures 2.19 and 2.20

Peak Month Surface Water Availability for the Delaware, Lehigh and Schuylkill Rivers.

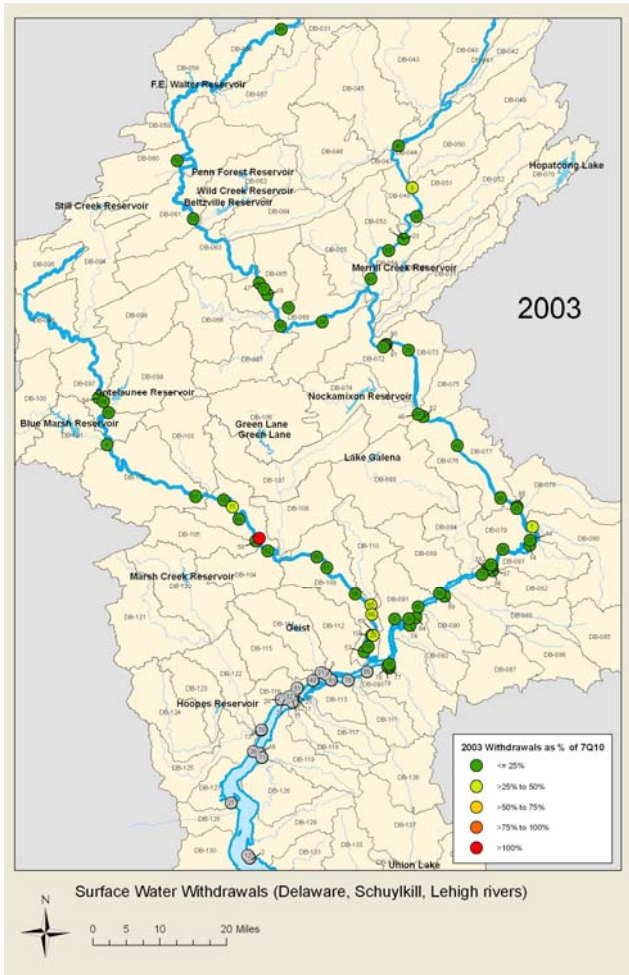

Figure 2.19 2003

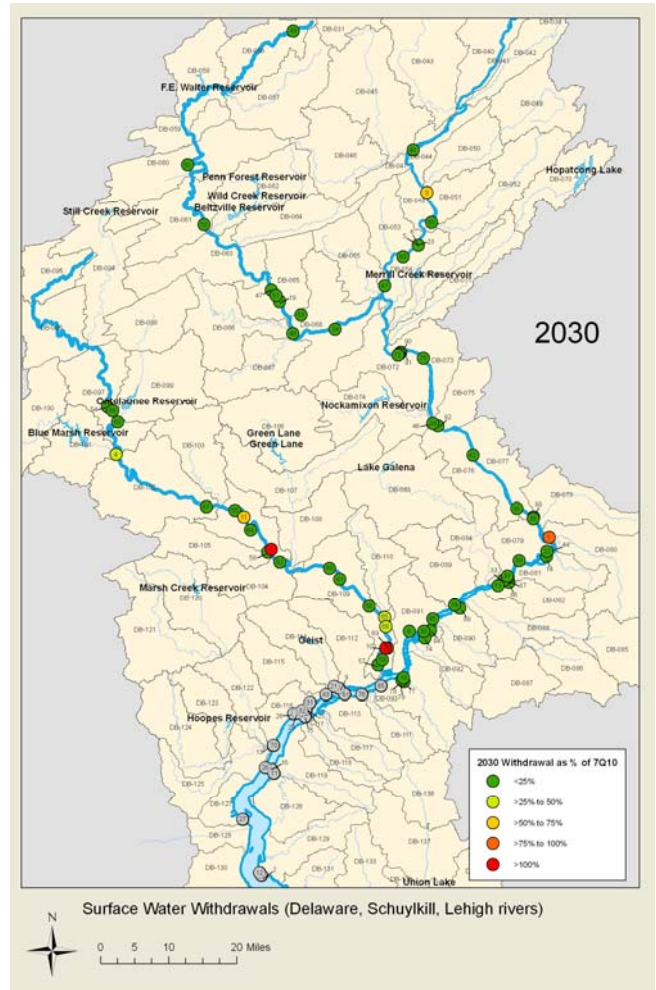

Figure 2.20 2030

## 2.3 CALCULATING WATER SUPPLY DEFICITS

### 2.3.1 Water Supply Deficits in Watersheds Identified for Further Study

The results of the basinwide water supply-demand evaluation identified several watersheds where the supply-demand balance indicated possible water supply problems. The location of these watersheds are shown in Figure 2.21 along with a graphic of the projected water use in each watershed that shows which sectors are driving water use. In total, ten watersheds have been identified, all of which are located in the lower half of the Basin.

Water supply deficits were quantified for all eight watersheds identified in Figure 2.21. In general, deficits were calculated by computing the amount of Q<sub>7</sub>10 needed for surface water watersheds and the amount of baseflow needed for ground water watersheds in order to lower utilization below the adopted threshold value of 75%.

An interior watershed was identified for further study if:

$$\frac{\sum \text{SurfaceWaterConsumptiveUse}}{Q_{710}} \geq 75\%$$

or:

$$\frac{\sum \text{GroundWaterWithdrawals}}{25\text{yrBaseflow}} \geq 75\%$$

Deficits were computed using withdrawals and consumptive use values generated for the years 2003 and 2030 respectively along with the alternatives of reducing the Q<sub>7</sub>10 and baseflow quantities by 25%, 50%, and 75% from their 2003 values. These percent reduction alternatives were done to simulate drought conditions in the watersheds and to check the sensitivity of the calculated water supply deficit to hypothetical reductions in supply. These percent reductions were not intended to represent conditions similar to the 1960s drought of record in the Basin. They were intended to be utilized as a screening tool in this reconnaissance level analysis.

Overall in the year 2030, five of the watersheds show a potential problem based on ground water use, and three show a potential problem based on surface water use. No watershed was flagged based on both ground water and surface water conditions.

In general, the drivers of water demand in these watersheds fall into two categories: public water supply and irrigation-related uses. Five of the watersheds (DB-090, DB-092, DB-108, DB-111 and DB-127) have public water supply as their largest use sector. Two of these watersheds (DB-090 and DB-092) show water demand from the public water supply sector projected to go down by 2030, which is likely to alleviate pressure on the watershed but is not sufficient to reduce demand enough to change the overall level of stress; the remaining three watersheds are projected to show increases in water demand for public water supply, due primarily to population growth.

There was only one basin in Pennsylvania that was identified as being deficient, DB-108. The basin is located on the lower Perkiomen Creek in the Schuylkill River Basin. A single surface water withdrawal accounts for over 85% of total surface water diversions for this basin. However, the Perkiomen Creek is augmented by a diversion of water from the Delaware River (via the East Branch of the Perkiomen Creek) and the upstream Green Lane Reservoir also provides water for drinking water supply, therefore the actual impacts of water use in this watershed are already mitigated.

Water demand for the public water supply sector in watershed DB-111, is also projected to increase by 2030. The sector is comprised of a number of water purveyors in Gloucester and Camden counties, NJ. These are primarily municipal supply systems that may be able to achieve reductions in water use by improving water supply infrastructure, in addition to other end-use water conservation efforts. A further examination of the socio-economic composition of the communities supplied by these systems may help determine the most effective methods of water conservation.

Further south in the Basin, several watersheds showing potential stress have significant water demands coming from the agricultural and non-agricultural irrigation sectors. In the two watersheds (DB-117 and DB-118) where agricultural water demand is the dominant sector, the projected trend in withdrawals is one of decline. It should be noted that agricultural water use has been derived from estimates based on U.S. Agricultural Census data, whereas other sectors have actual water withdrawal data (locations and volumes) available and therefore provide more accurate accounting of water demand. Further study to confirm water use is recommended in the watersheds where a significant portion of the water use has been estimated.

In watershed DB-137 the majority of water demand (>75%) is for non-agricultural use; this demand is driven by one nursery operation with multiple ground water sources. This sector is projected to increase in water use and is expected to account for the majority of the overall 15% increase in water demand in this watershed.

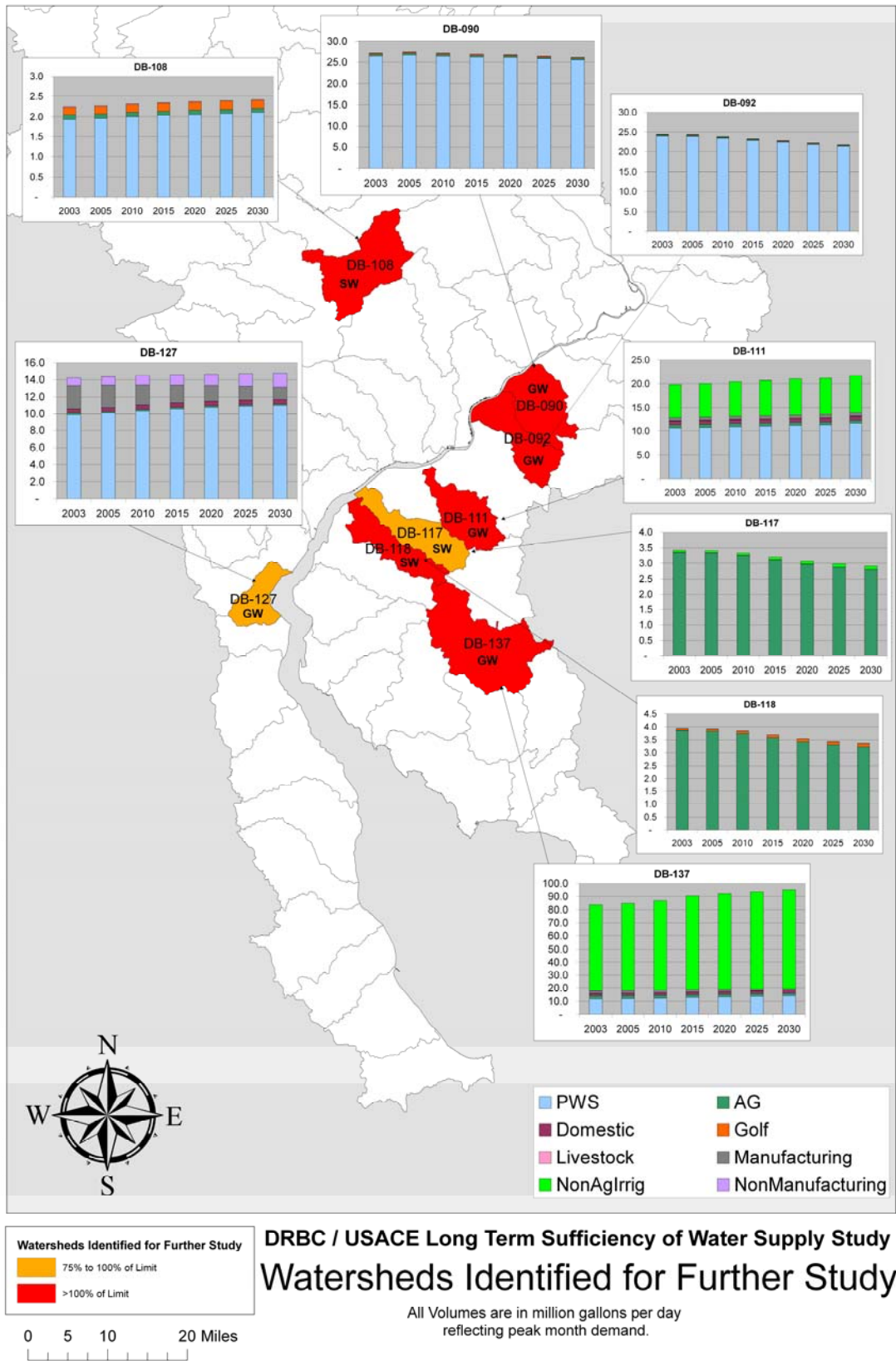

Figure 2.21. Watersheds Identified for Further Study

Tables 2.9 to 2.11 summarize the withdrawals, consumptive uses, and calculated deficits for the eight watersheds and Figures 2.22 to 2.27 graphically show the surface and ground water deficits for the eight watersheds. As Figure 2.21 shows, basin DB-108 in Pennsylvania was surface water deficient by 1.35 MGD in year 2003 and projected to be 1.67 MGD deficient in the year 2030. Reducing the Q<sub>7</sub>10 in this basin by 25%, 50%, and 75% increases the deficit from 1.35 MGD to 2.0 MGD, 2.41 MGD, and 2.82 MGD respectively.

The two New Jersey basins that are surface water deficient (DB-117 and DB-118) need a total of 2.85 MGD in year 2003 and 1.74 MGD in year 2030. This reduction can be explained by the fact that the projected withdrawals and consumptive use values for year 2030 are lower than the values used for 2003. The four New Jersey basins that are ground water deficient (DB-90, DB-92, DB-111 and DB-137) need a total of 90.4 MGD for year 2003 and it increases to 109.36 MGD in year 2030. Combining the surface water and ground water deficiencies for the New Jersey basins gives 93.3 MGD in year 2003 and 111.1 MGD in year 2030. The hypothetical 25%, 50%, and 75% reductions in Q<sub>7</sub>10 and 25-year baseflow supply values increase the amount of water needed by these basins to 135.4 MGD, 165.76, and 196.12 MGD respectively

There is one watershed in the State of Delaware (DB-127) identified as being deficient in ground water. The ground water deficient watershed in Delaware (DB-127) needs 0.43 MGD using 2003 values and projected to need 1.77 MGD in year 2030. Refer to Technical Appendix A for additional tables and graphs summarizing in more detail withdrawals, consumptive uses, and deficit quantities for these eight watersheds.

Table 2.9  
Withdrawals at Identified Surface Water Deficient Basins

Basins	Year 2003 ΣWD (mgd)	Year 2003 ΣCU (mgd)	Year 2030 ΣWD (mgd)	Year 2030 ΣCU (mgd)
DB-108	19.70	2.25	21.46	2.42
<b>PA TOTAL</b>	<b>19.70</b>	<b>2.25</b>	<b>21.46</b>	<b>2.42</b>
DB-117	3.80	3.42	3.24	2.91
DB-118	4.39	3.95	3.73	3.36
<b>NJ TOTAL</b>	<b>8.18</b>	<b>7.37</b>	<b>6.97</b>	<b>6.27</b>

ΣWD = Cumulative Withdrawals within Basin      ΣCU = Cumulative Consumptive Use Within Basin

Table 2.10  
Withdrawals at Identified Ground Water Deficient Basins

Basins	Year 2003 ΣWD (mgd)	Year 2003 ΣCU (mgd)	Year 2030 ΣWD (mgd)	Year 2030 ΣCU (mgd)
DB-90	27.20	3.21	26.19	3.06
DB-92	22.90	2.63	20.53	2.34
DB-111	19.80	8.19	21.64	8.89
DB-137	83.78	63.06	95.23	71.80
<b>NJ TOTAL</b>	<b>153.67</b>	<b>77.09</b>	<b>163.60</b>	<b>86.09</b>
DB-127	12.89	1.33	13.27	1.40
<b>DE TOTAL</b>	<b>12.89</b>	<b>12.89</b>	<b>12.89</b>	<b>12.89</b>

ΣWD = Cumulative Withdrawals within Basin      ΣCU = Cumulative Consumptive Use Within Basin

Table 2.11  
 Combined SW and GW Deficits at Various Percent Reductions in Supply

State	Basin	Water Deficiency	Supply Deficit (mgd)				
			Year 2003	5% Red. (2030)	25% Red.	50% Red.	75% Red.
PA	DB-108	SW	1.35	1.67	2	2.41	2.82
<b>PA TOTAL</b>			<b>1.35</b>	<b>1.67</b>	<b>2</b>	<b>2.41</b>	<b>2.82</b>
NJ	DB-117	SW	0.91	0.42	1.15	2.06	2.97
NJ	DB-118	SW	1.95	1.33	1.99	2.82	3.65
<b>NJ SW TOTAL</b>			<b>2.85</b>	<b>1.74</b>	<b>3.14</b>	<b>4.88</b>	<b>6.62</b>
NJ	DB-90	GW	14.18	13.94	18.36	23.88	29.4
NJ	DB-92	GW	10.37	8.22	12.25	17.29	22.33
NJ	DB-111	GW	6.68	10.13	14.08	19	23.93
NJ	DB-137	GW	59.17	77.07	87.57	100.71	113.84
<b>NJ GW TOTAL</b>			<b>90.4</b>	<b>109.36</b>	<b>132.26</b>	<b>160.88</b>	<b>189.51</b>
<b>NJ TOTAL</b>			<b>93.26</b>	<b>111.1</b>	<b>135.4</b>	<b>165.76</b>	<b>196.12</b>
DE	DB-127	GW	0.43	1.77	5.12	9.31	13.5
<b>DE TOTAL</b>			<b>0.43</b>	<b>1.77</b>	<b>5.12</b>	<b>9.31</b>	<b>13.5</b>

SW Water Deficiency - Basin is Identified as being Deficient (Q<sub>710</sub>) in Surface Water in Order to Meet SW Needs  
 GW Water Deficiency - Basin is Identified as being Deficient (25-yr Baseflow) in Ground Water in Order to Meet GW Needs

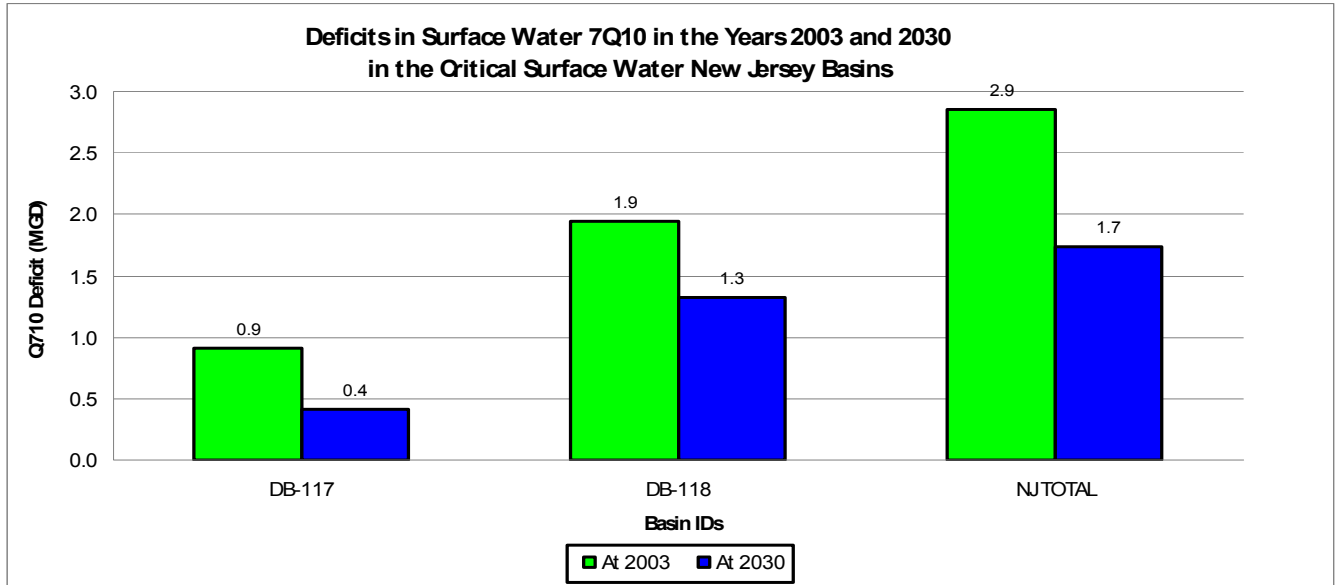

Figure 2.22

The deficits in 2030 are less than they are in 2003 because projected demands for these basins in 2030 are less than the demands in 2003. The Q<sub>710</sub> in 2030 was reduced by 5% from the 2003 value in order to account for climate variability.



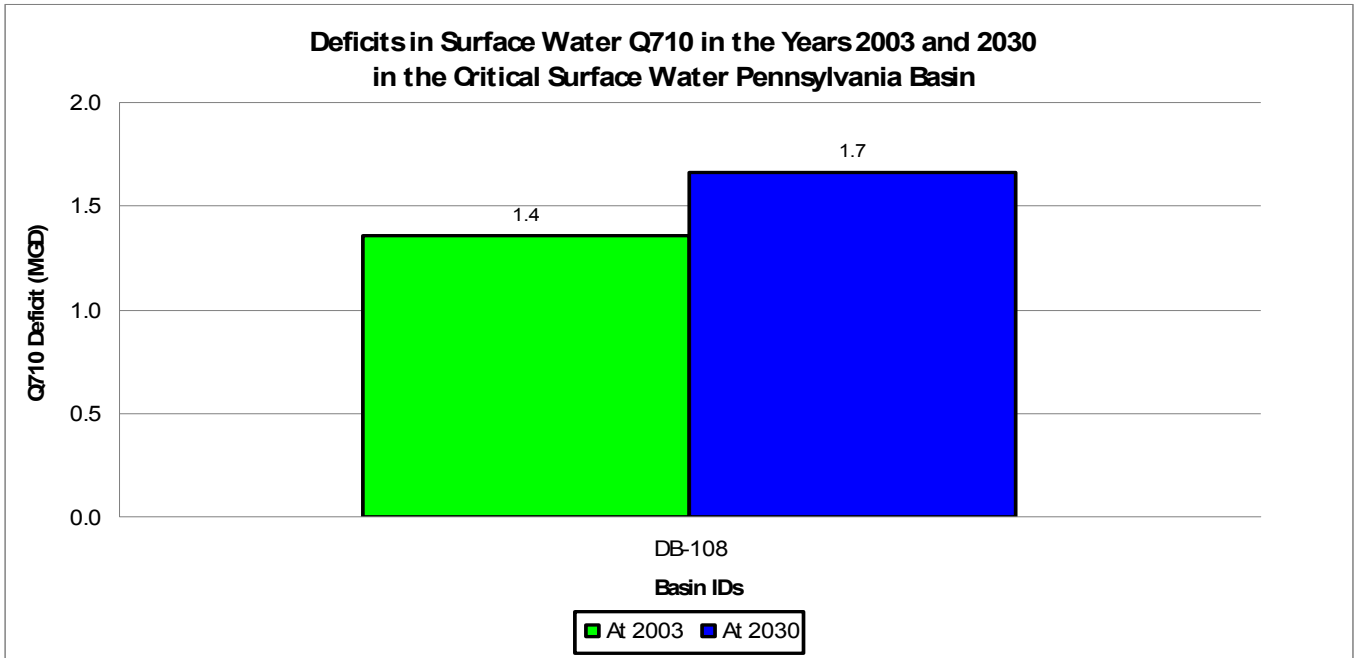

Figure 2.23  
*The Q<sub>710</sub> in 2030 was reduced by 5% from the 2003 value in order to account for climate variability.*

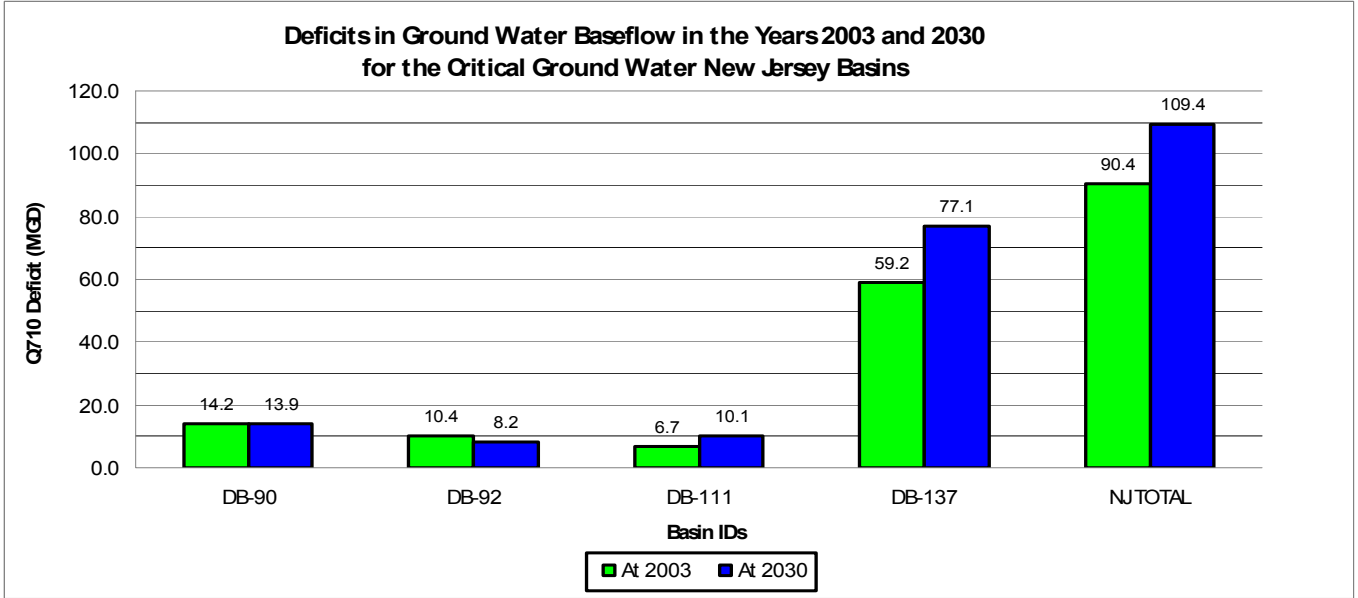

Figure 2.24  
*The deficit in 2030 is less than it is in 2003 for basins DB-90 and DB-92 because projected demands for the basins in 2030 are less than the demands in 2003. The baseflow in 2030 was reduced by 5% from the 2003 water supply value in order to account for climate variability.*

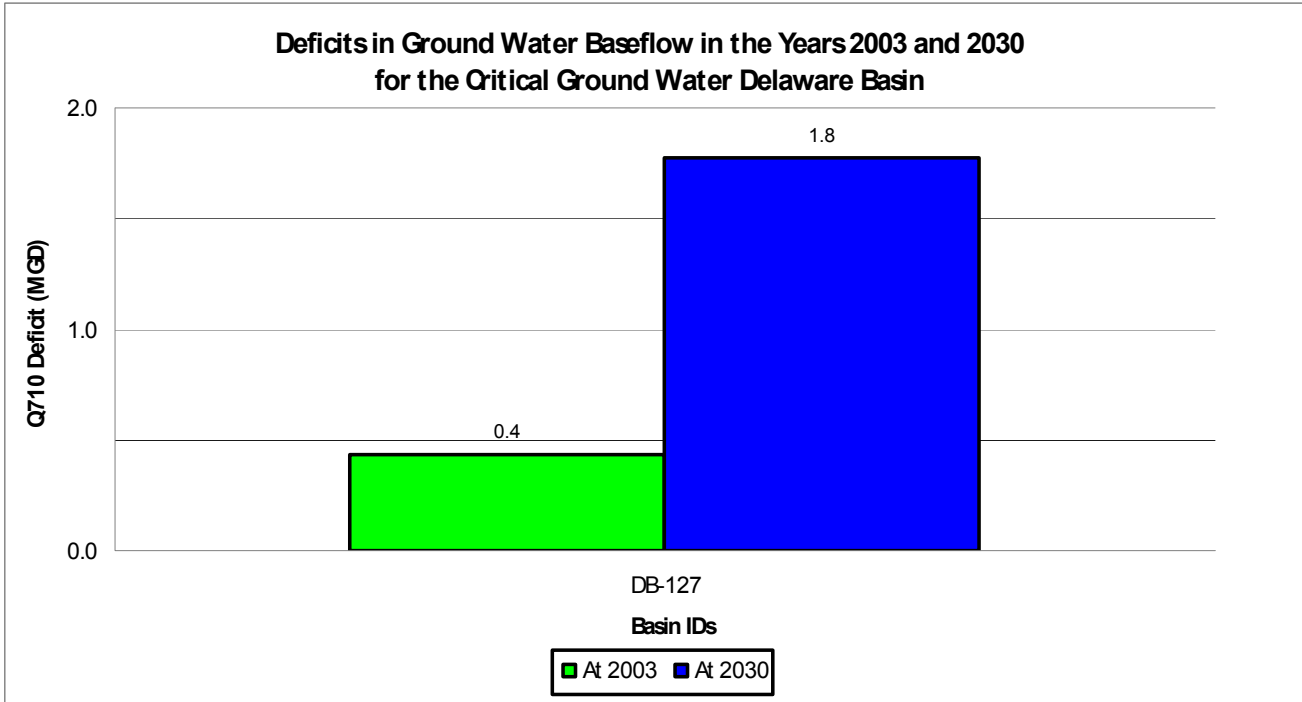

Figure 2.25

The baseflow in 2030 was reduced by 5% from the 2003 water supply value in order to account for climate variability.

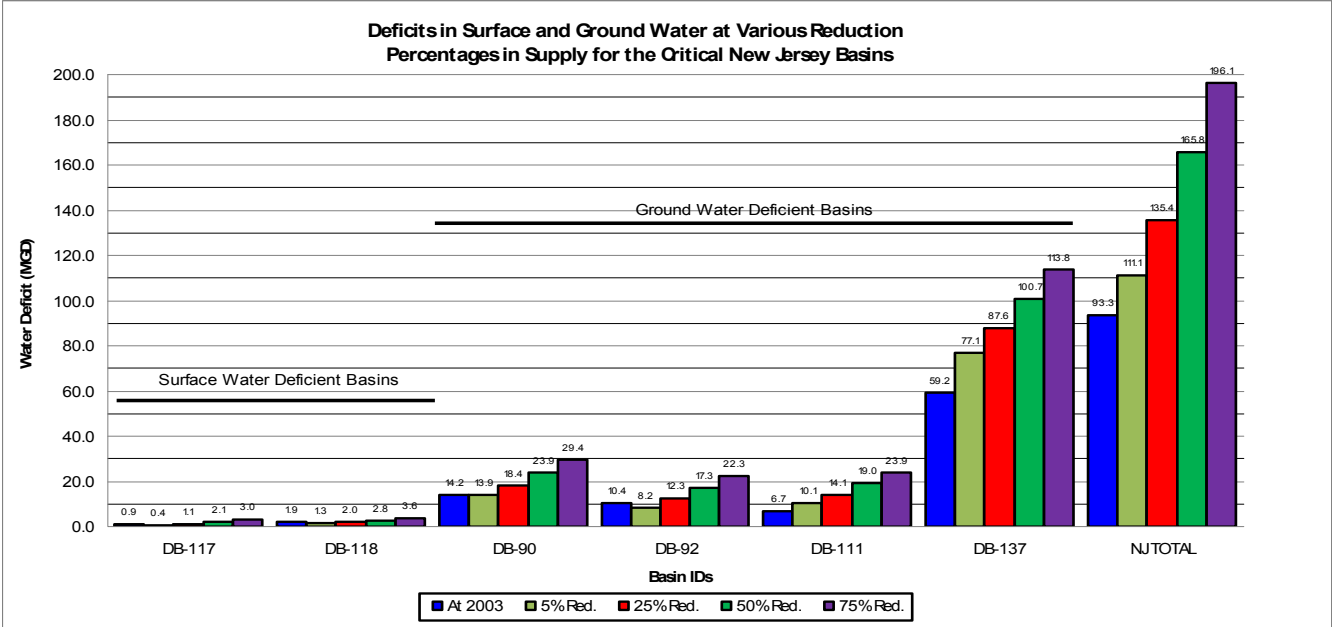

Figure 2.26

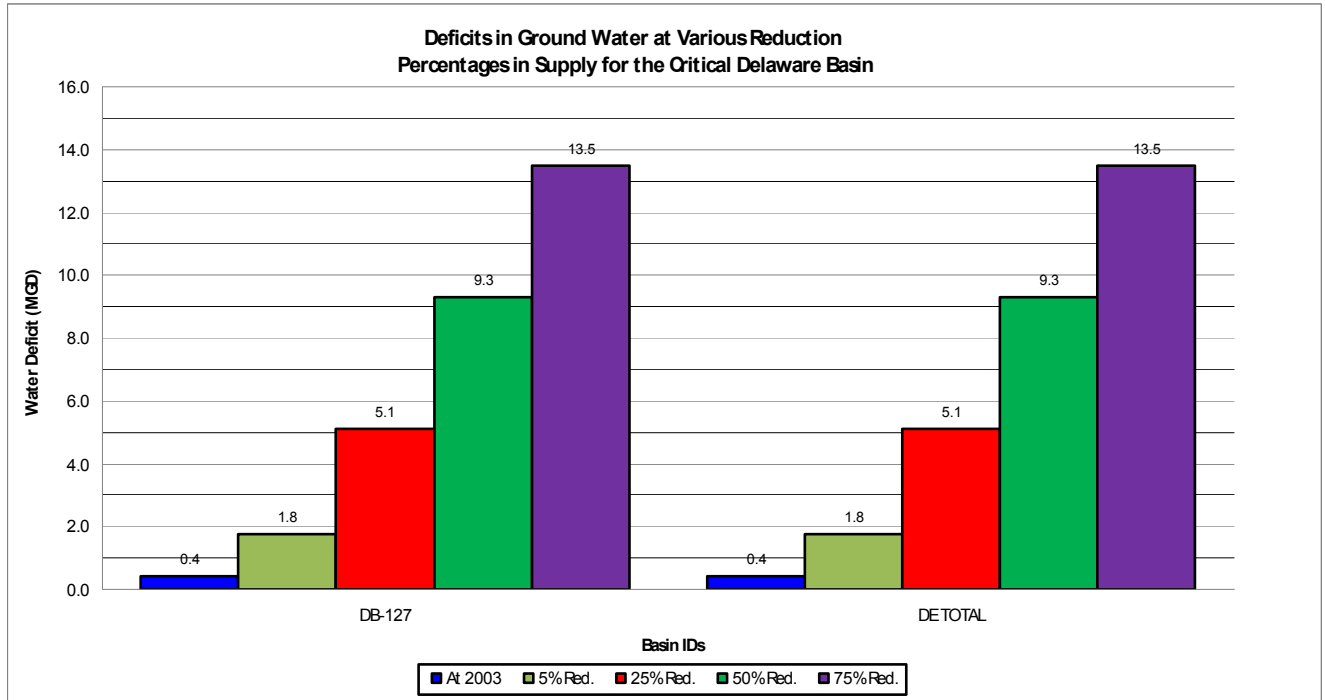

Figure 2.27

### 2.3.2 Calculating Water Deficiencies for the Delaware, Schuylkill and Lehigh Rivers

In addition to a watershed analysis, the team obtained data of surface water withdrawals for the Delaware, Lehigh, and Schuylkill Rivers. This data included the quantity of water withdrawn from the river in 2003 and projected to be withdrawn in 2030. Consumptive use quantities for each surface water withdrawal in the year 2003 along with a projected value for 2030 were also obtained. Figure 2.29 shows the locations of each surface water withdrawal point along the three rivers. The seven-day, consecutive low flow with a ten year return frequency statistic ( $Q_{710}$ ) was used as the water supply parameter for the river analysis. The  $Q_{710}$  statistic is a commonly used low-flow statistic in determining water supply adequacy. It should be noted that the  $Q_{710}$  does not represent the drought of record for the Basin which occurred in the 1960s. Flows in the Delaware and Schuylkill Rivers during the drought of the 1960s were smaller than the computed  $Q_{710}$  in each river.

The additional flows needed to meet water supply deficits at the  $Q_{710}$  level were quantified at a given withdrawal point if:

$$\frac{Withdrawal(WD)}{7Q_{10} - \sum ConsumptiveUseUpstreamWithdrawalPoint(CU)} \geq 75\%$$

Additional flows needed to alleviate water supply deficits were computed for the year 2003, projected conditions in the year 2030, and several “simulated” drought conditions (which will be discussed later). In general, the additional flows needed were calculated by computing the amount of  $Q_{710}$  needed in order to lower utilization below the adopted threshold value of 75%.

Re-arranging the above equation and adding a term to represent the amount of water needed to add to the  $Q_{710}$  to alleviate the deficit gives the expression used at each point.

$$\text{AdditionalFlowNeeded} = 1.34 * WD + \sum CU - 7Q_{10}$$

The accumulated additional flow needed at the downstream end of each river was used as the minimum value that any proposed water supply alternative or combination of alternatives had to meet.

It was assumed for the river analysis that the computed additional flow needed at withdrawal points for the power sector would be isolated from deficits computed for all other withdrawal points. The reasoning behind this assumption was that power generation can be considered to be mobile in nature. In other words, if it was projected that additional power would be need to be generated at a given location; the additional generation could come from another location on the power grid within the Basin where water is more plentiful and not necessarily at the same location along the river. An example of an alternative location within the basin is at the Delaware River Estuary. Therefore, the additional water needed by the power sector in order to meet future demands may not materialize because the power sector could meet those demands by other means. It was assumed that projected increases in power generation output at existing facilities would not stress river segments that are already projected to be stressed. A reasonable assumption was made that any potential alternative source(s) of water that was deemed necessary in order to alleviate deficits would not be evaluated based upon the downstream power sector but would be based upon meeting the needs of public water supply and other sectors and be sized accordingly.

Thermoelectric power generation is the largest water use sector in the Delaware River Basin. Thermoelectric power generation, and the water demands for this sector, have shown a steady increase in recent decades and are projected to continue to increase. Managing the anticipated growth of the thermoelectric power sector will play an important role in providing a sustainable water supply for all water use sectors.

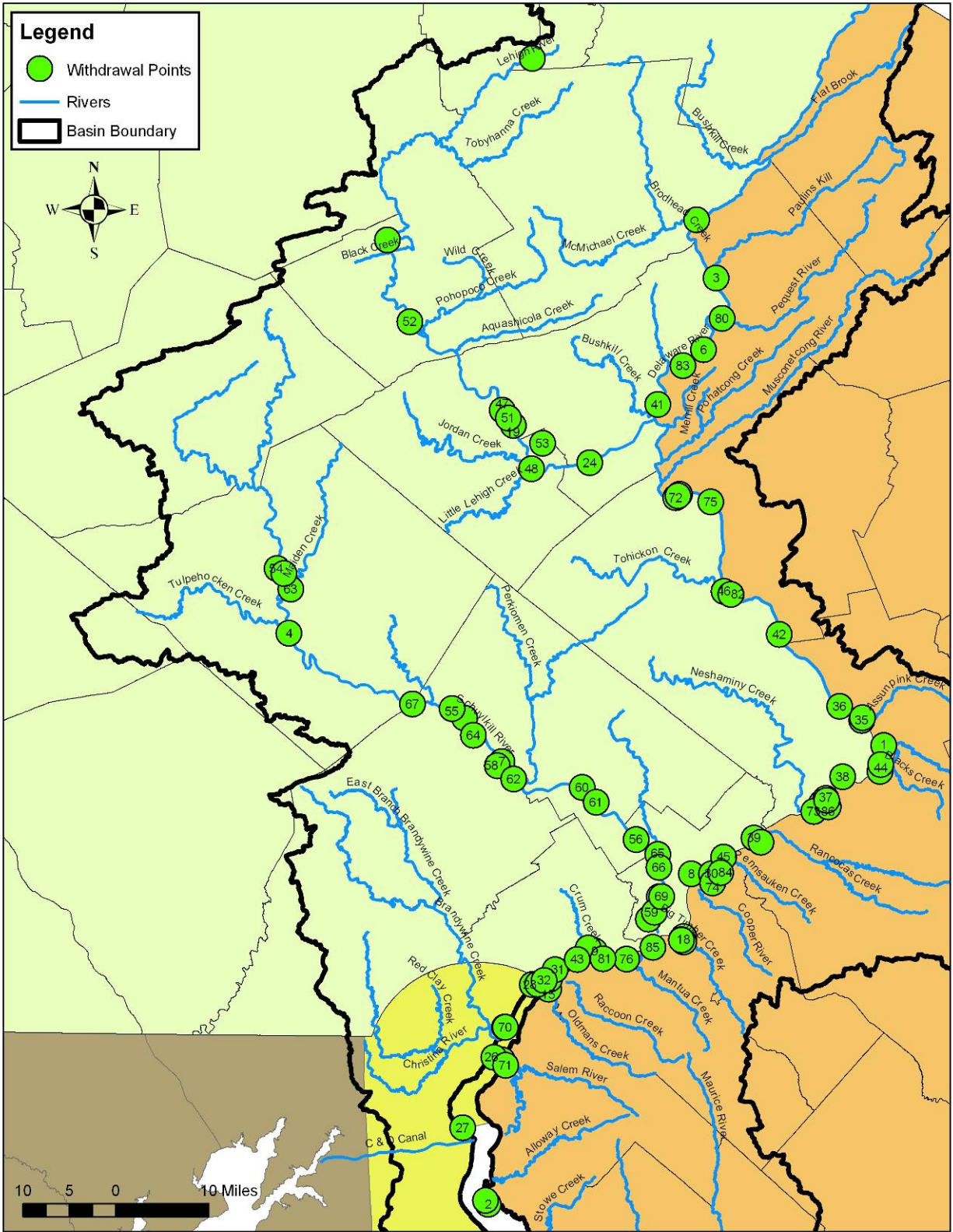

Figure 2.28: Location of Withdrawal Points on Delaware, Schuylkill, and Lehigh Rivers

**2.3.2.1 Deficiencies in Year 2003.** Utilizing the existing data for the year 2003, existing deficiencies if any were calculated for the Delaware, Schuylkill and Lehigh Rivers. As shown in Table 12, the Delaware River did not have any identified deficient withdrawal points in 2003. This was true for the power sector and all other sectors incorporated into the analysis. The Schuylkill River in the year 2003 also did not have any points where additional flow was needed to supplement the natural  $Q_{710}$  for non-power sectors. The only deficiency on the Schuylkill River was at a single power sector withdrawal located just upstream of the Perkiomen Creek. The additional flow needed at that withdrawal point was calculated to be 90 mgd (Table 2.13). As with the Delaware River, the Lehigh River did not have any deficiencies identified at withdrawal points in the year 2003 (Table 2.14).

Figures were created that summarized the tabular analysis done for each river. The figures summarized the  $Q_{710}$ , withdrawals, consumptive uses, and deficits by reach that were shown on each table. Reaches were defined as shown in Figures 2.29-2.30 for the Schuylkill and Delaware Rivers respectively. Figure 2.30 corresponds to the analysis done in Table 2.12 and shows that there were no deficits on the Delaware River in 2003. Figure 2.32 corresponds to the analysis done in Table 2.13 and shows the power-sector deficit of 90 mgd in Reach 2 between the Tulpehocken and Perkiomen Creeks.

Table 2.12  
Delaware River Year 2003 Water Supply Conditions

Map ID	Water Use Type	Natural Q710 for Year 2003 (mgd)	Cumul. Consumptive Use Above Withdrawal Point for Year 2003 (mgd)	Withdrawal at Point for Year 2003 (mgd)	Withdrawal as Percentage of Natural Q710 (mgd)	Additional Flow Needed to Lower Utilization Below 75% for Power Sector (mgd)	Additional Flow Needed to Lower Utilization Below 75% for Other Sectors (mgd)
<b>USGS GAGE @ DELAWARE WATER GAP</b>							
40	GOLF	978.37	0.00	0.31	0.03	0.00	0.00
<b>BRODHEAD CREEK</b>							
3	PWR	1114.06	0.28	305.24	27.41	0.00	0.00
80	MANUF	1117.74	1.55	1.82	0.16	0.00	0.00
5	PWR	1163.12	2.10	26.04	2.24	0.00	0.00
6	PWR	1163.12	2.41	8.81	0.76	0.00	0.00
23	PWR	1163.12	4.75	0.00	0.00	0.00	0.00
83	RES.	1163.12	4.75	0.00	0.00	0.00	0.00
41	INTAKE PWS	1185.39	4.75	8.03	0.68	0.00	0.00
<b>LEHIGH RIVER</b>							
75	MANUF	1633.87	7.71	0.00	0.00	0.00	0.00
72	PWR	1633.87	7.71	0.99	0.06	0.00	0.00
90	AG	1633.87	7.90	0.00	0.00	0.00	0.00
91	AG	1633.87	7.90	0.00	0.00	0.00	0.00
34	PWS	1684.80	7.90	17.38	1.04	0.00	0.00
<b>TOHICKON CREEK</b>							
46	PWS	1684.80	9.63	21.57	1.29	0.00	0.00
<b>DELAWARE &amp; RARITAN CANAL - NODE 82 WITHDRAWAL</b>							
82	PWS	1685.50	11.79	91.52	5.47	0.00	0.00
42	PWS	1708.01	103.32	0.01	0.00	0.00	0.00
88	PWS	1730.67	103.32	30.46	1.87	0.00	0.00
36	PWS	1730.67	103.32	2.96	0.18	0.00	0.00
<b>USGS GAGE AT TRENTON</b>							
35	PWS	1730.72	106.36	3.03	0.19	0.00	0.00
<b>ASSUNIPINK CREEK</b>							
1	PWR	1761.68	106.67	631.62	38.16	0.00	0.00
22	PWR	1804.79	110.27	0.21	0.01	0.00	0.00
44	COMM	1804.79	110.34	45.89	2.71	0.00	0.00
14	PWR	1805.01	114.93	42.85	2.54	0.00	0.00
38	PWS	1805.01	115.52	7.73	0.46	0.00	0.00

Table 2.12  
Delaware River Year 2003 Water Supply Conditions (Continued)

Map ID	Water Use Type	Natural Q710 for Year 2003 (mgd)	Cumul. Consumptive Use Above Withdrawal Point for Year 2003 (mgd)	Withdrawal at Point for Year 2003 (mgd)	Withdrawal as Percentage of Natural Q710 (mgd)	Additional Flow Needed to Lower Utilization Below 75% for Power Sector (mgd)	Additional Flow Needed to Lower Utilization Below 75% for Other Sectors (mgd)
37	PWS	1821.66	116.29	5.45	0.32	0.00	0.00
87	PWS	1821.67	116.84	0.00	0.00	0.00	0.00
33	MANUF	1822.53	116.84	0.42	0.02	0.00	0.00
86	PWS	1835.24	116.88	1.78	0.10	0.00	0.00
73	PWR	1836.23	117.06	0.05	0.00	0.00	0.00
<b>NESHAMINY CREEK</b>							
39	PWS	1990.99	117.11	157.72	8.42	0.00	0.00
89	PWS	1993.07	132.88	19.59	1.05	0.00	0.00
45	MANUF	2012.21	134.84	1.48	0.08	0.00	0.00
84	MANUF	2023.09	134.85	0.20	0.01	0.00	0.00
30	MANUF	2023.09	134.87	19.77	1.05	0.00	0.00
74	MINING	2032.82	136.85	0.00	0.00	0.00	0.00
8	PWR	2035.00	136.85	97.93	5.16	0.00	0.00
18	PWR	2054.11	138.23	15.94	0.83	0.00	0.00
77	MANUF	2054.12	138.31	0.00	0.00	0.00	0.00
78	MANUF	2054.13	138.31	0.00	0.00	0.00	0.00
79	MANUF	2054.13	138.31	0.00	0.00	0.00	0.00
<b>SCHUYLKILL RIVER</b>							
<b>TOTALS</b>			<b>138.31</b>	<b>1566.80</b>		<b>0.00</b>	<b>0.00</b>

*Bold values denote where utilization exceeds 75%*

*Consumptive Use, Withdrawals, and Q710 Values from Year 2003*



Table 2.13  
Schuylkill River Year 2003 Water Supply Conditions

Map ID	Water Use Type	Natural Q710 for Year 2003 (mgd)	Cumul. Consumptive Use Above Withdrawal Point for Year 2003 (mgd)	Withdrawal at Point for Year 2003 (mgd)	Withdrawal as Percentage of Natural Q710 (mgd)	Additional Flow Needed to Lower Utilization Below 75% for Power Sector (mgd)	Additional Flow Needed to Lower Utilization Below 75% for Other Sectors (mgd)
54	AG	60.94	0.00	0.00	0.00	0.00	0.00
68	MANUF	61.02	0.00	0.00	0.00	0.00	0.00
<b>MIADEN CREEK</b>							
63	MANUF	93.18	0.00	0.40	0.43	0.00	0.00
4	PWR	96.75	0.04	16.62	17.19	0.00	0.00
<b>TULPEHOCKEN CREEK - BLUE MARSH RESERVOIR</b>							
<b>USGS GAGE AT READING</b>							
67	PWS	152.60	1.47	4.57	3.03	0.00	0.00
<b>MANATAWNY CREEK</b>							
<b>USGS GAGE AT POTTSTOWN</b>							
55	MANUF	167.28	1.92	0.12	0.07	0.00	0.00
11	PWR	169.99	1.94	43.01	25.60	0.00	0.00
64	PWS	172.96	35.86	2.10	1.53	0.00	0.00
58	PWS	175.98	36.07	3.23	2.31	0.00	0.00
7	<b>PWR</b>	<b>176.02</b>	<b>36.40</b>	<b>171.62</b>	<b>122.92</b>	<b>90.35</b>	<b>0.00</b>
62	PWS	188.14	37.34	25.00	16.58	0.00	0.00
<b>PERKIOMEN CREEK</b>							
60	PWS	257.40	39.84	10.75	4.94	0.00	0.00
<b>USGS GAGE AT NORRISTOWN</b>							
61	MANUF	258.84	40.91	0.28	0.13	0.00	0.00
56	MANUF	272.20	40.94	6.48	2.80	0.00	0.00
<b>WISSAHICKON CREEK</b>							
65	PWS	274.57	41.01	85.22	36.49	0.00	0.00
66	PWS	274.96	126.24	55.63	37.40	0.00	0.00
<b>USGS GAGE AT PHILADELPHIA</b>							
20	PWR	275.94	181.86	33.99	36.13	0.00	0.00
69	PWR	275.94	181.90	3.75	3.99	0.00	0.00
10	PWR	275.94	182.24	22.52	24.03	0.00	0.00
59	MANUF	277.46	182.32	4.00	4.20	0.00	0.00
57	MANUF	277.58	183.45	15.87	16.86	0.00	0.00
<b>DELAWARE RIVER</b>							
<b>TOTALS</b>			<b>183.45</b>	<b>505.16</b>		<b>90.35</b>	<b>0.00</b>

*Bold values denote withdrawal point where utilization exceeds 75% Consumptive Use, Withdrawals, and Q710 Values from Year 2003*

Table 2.14  
Lehigh River Year 2003 Water Supply Conditions

Map ID	Water Use Type	Natural Q710 for Year 2003 (mgd)	Cumul. Consumptive Use Above Withdrawal Point for Year 2003 (mgd)	Withdrawal at Point for Year 2003 (mgd)	Withdrawal as Percentage of Natural Q710 (mgd)	Additional Flow Needed to Lower Utilization Below 75% for Power Sector(mgd)	Additional Flow Needed to Lower Utilization Below 75% for Other Sectors(mgd)
49	GOLF	3.72	0.00	0.00	0.00	0.00	0.00
<b>FE WALTER RESERVOIR</b>							
50	PWR	86.94	0.00	0.00	0.00	0.00	0.00
52	MANUF	142.42	0.00	0.00	0.00	0.00	0.00
<b>USGS GAGE AT LEHIGHTON</b>							
<b>POHOPOCO CREEK - BELTZVILLE RESERVOIR</b>							
47	PWR	229.73	0.00	3.08	1.34	0.00	0.00
51	PWR	230.09	0.31	0.73	0.32	0.00	0.00
19	PWR	230.21	0.38	1.40	0.61	0.00	0.00
48	RES. INTAKE	230.21	1.78	0.00	0.00	0.00	0.00
<b>JORDAN CREEK</b>							
53	PWS	299.12	1.78	0.12	0.04	0.00	0.00
<b>USGS GAGE AT BETHLEHEM</b>							
24	PWR	313.42	1.79	0.54	0.17	0.00	0.00
<b>DELAWARE RIVER</b>							
<b>TOTALS</b>			<b>1.79</b>	<b>5.87</b>		<b>0.00</b>	<b>0.00</b>

*Consumptive Use, Withdrawals, and Q710 Values from Year 2003*

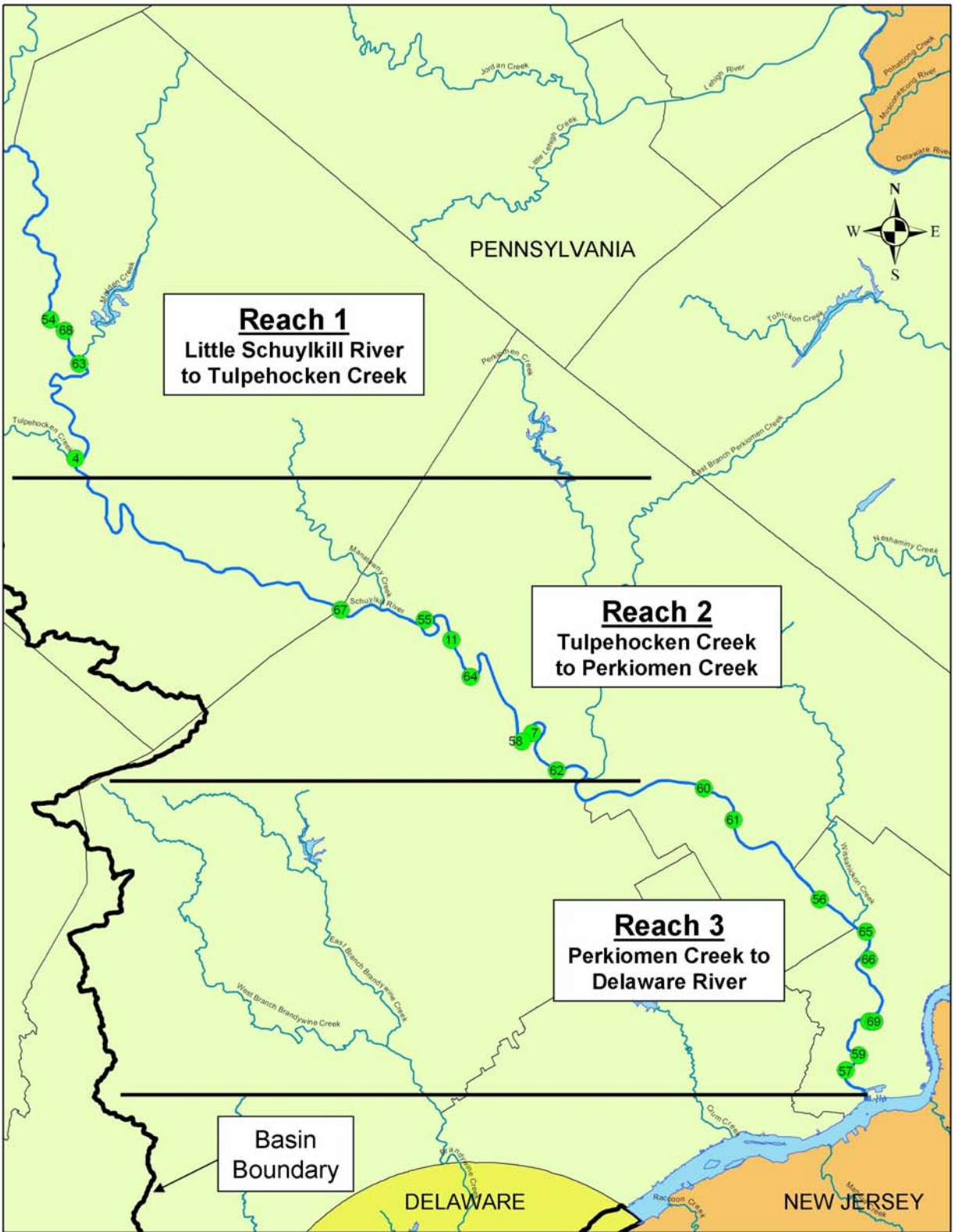

Figure 2.29: Schuylkill River Reaches

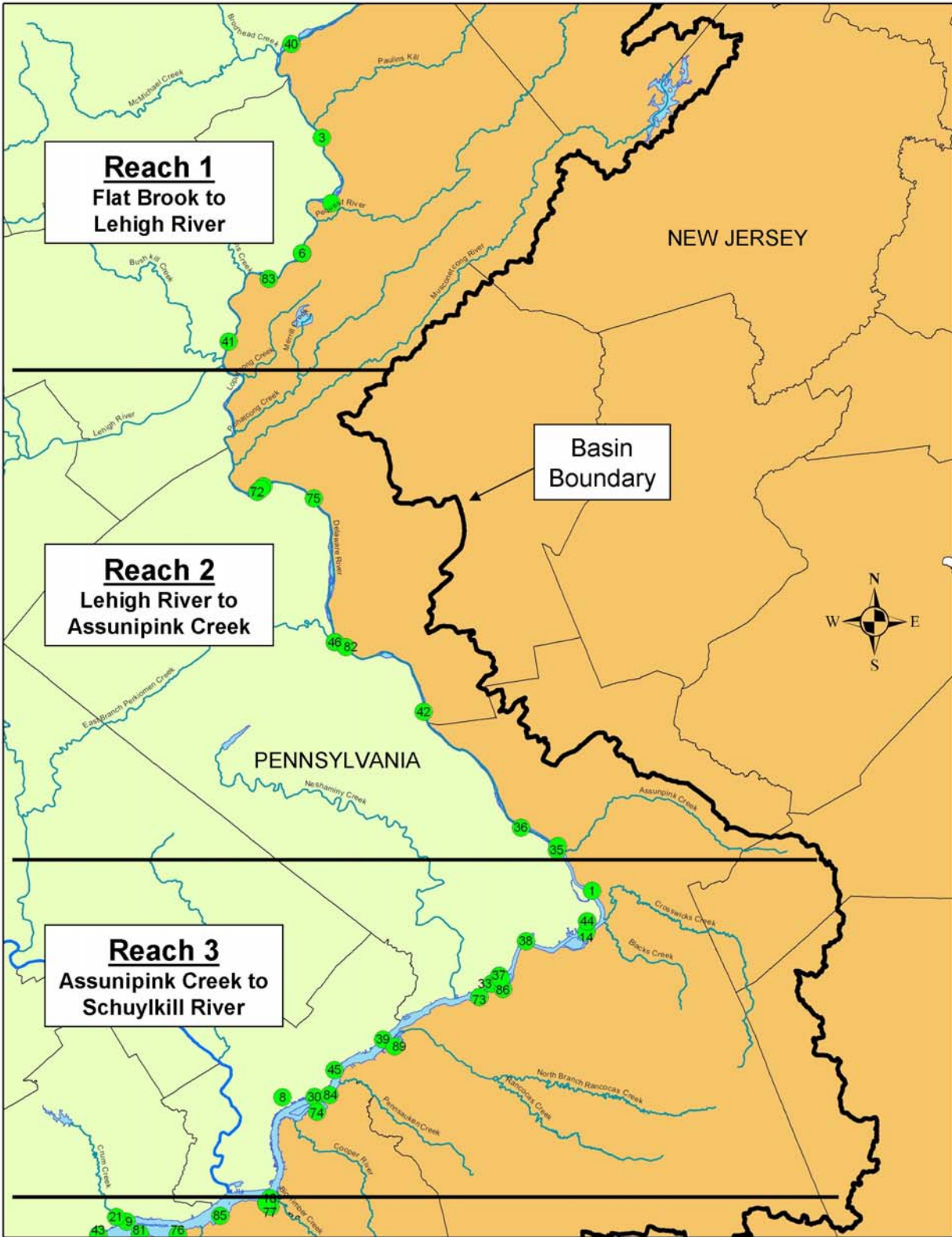
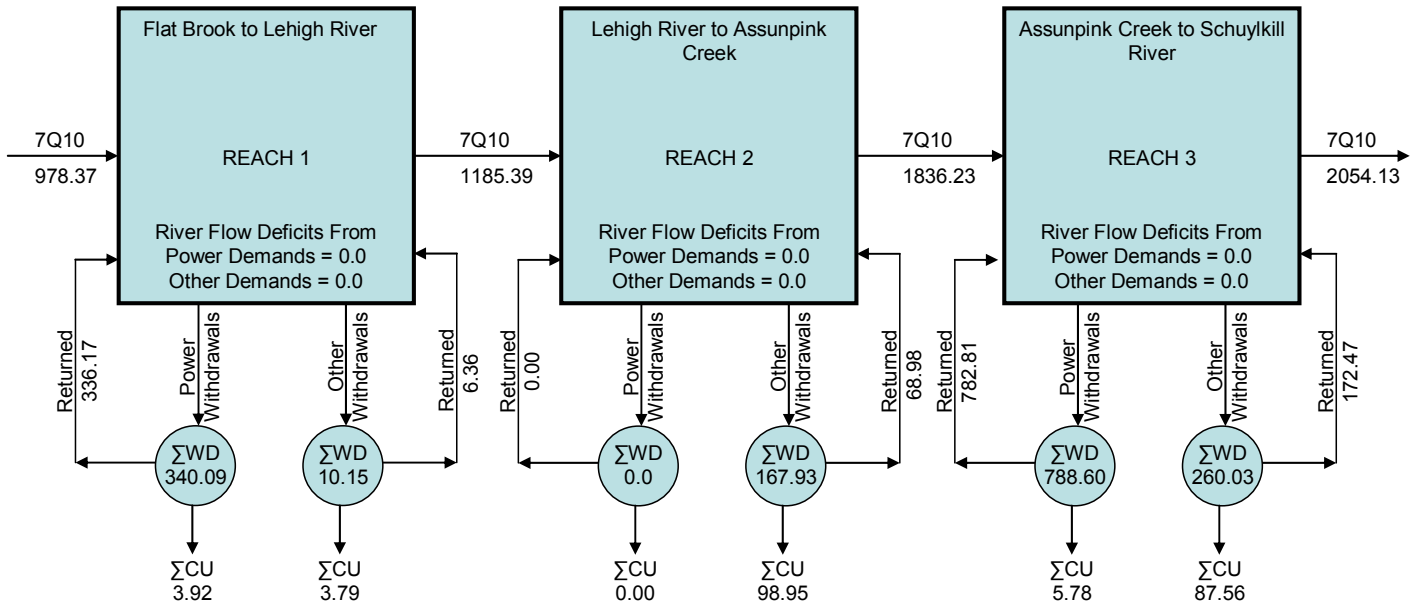

Figure 2.30 Delaware River Reaches

DELAWARE RIVER BASIN

DEMANDS: 2003 Values for Withdrawals and Consumptive Uses  
 SUPPLY: 2003 Values for 7Q10



KEY

7Q10 = Low Flow Indicator of a 7-Day Average Flow with a 10-Year Return Period

Power = Demands Placed Upon River from the Power Sector    Other = Demands Placed Upon River from Golf, Agricultural, Public Water Supply etc ...Sectors

ΣWD = Cumulative Surface Water Withdrawals within Reach    ΣCU = Cumulative Consumptive Use of Withdrawals within Reach

All Values Expressed as MGD

Figure 2.31 Delaware River Year 2003 Water Supply Conditions

SCHUYLKILL RIVER BASIN

DEMANDS: 2003 Values for Withdrawals and Consumptive Uses  
 SUPPLY: 2003 Values for 7Q10

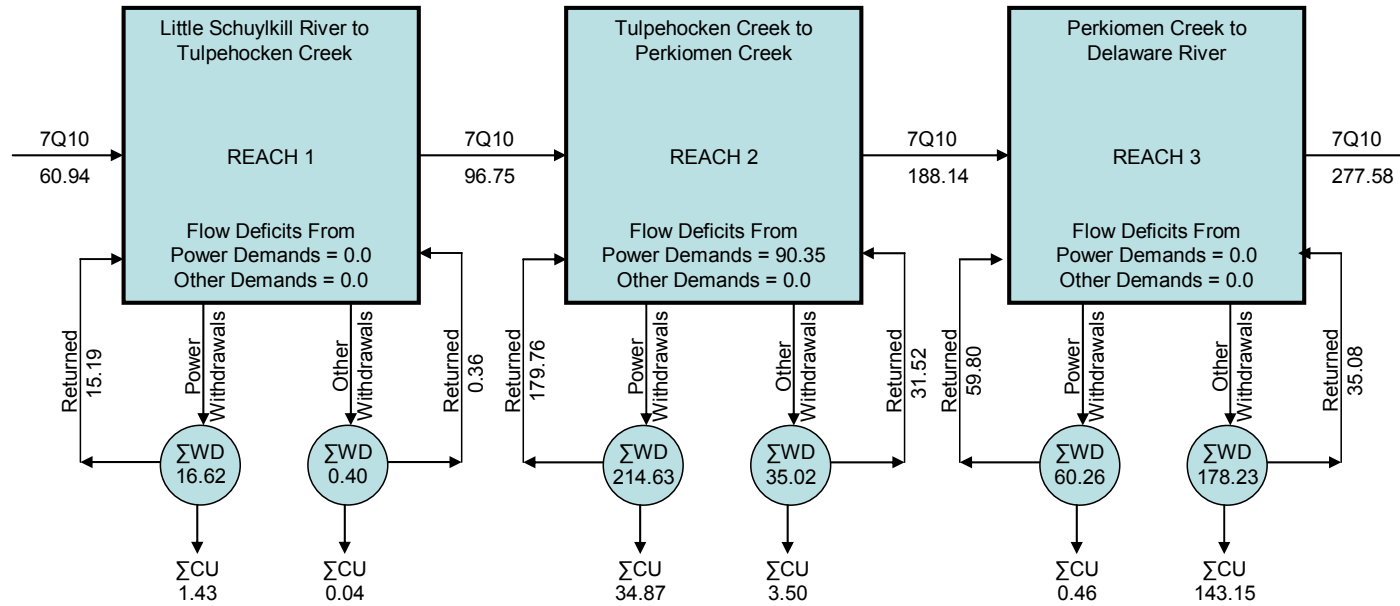

KEY

7Q10 = Low Flow Indicator of a 7-Day Average Flow with a 10-Year Return Period

Power = Demands Placed Upon River from the Power Sector    Other = Demands Placed Upon River from Agricultural, Public Water Supply, etc... Sectors

ΣWD = Cumulative Surface Water Withdrawals within Reach    ΣCU = Cumulative Consumptive Use of Withdrawals within Reach

All Values Expressed as MGD

Figure 2.32: Schuylkill River Year 2003 Water Supply Conditions

**2.3.2.2 Deficiencies in Year 2030.** As expected, deficiencies increased in the year 2030. The increased deficiencies along the rivers were attributable to two factors. First, as previously mentioned in the report, the analysis accounted for climate variability by reducing the natural  $Q_{7-10}$  values at each withdrawal point as shown in Tables 2.12-2.14 by 5%. Secondly, as was previously shown as well, demands are projected to increase on the rivers in the year 2030. The combination of potentially lower supplies and higher demands resulted in the higher deficiencies.

Projecting conditions out to the year 2030 on the Delaware River resulted in one power-sector withdrawal point being identified as deficient in the vicinity of Trenton, NJ. The deficiency on the Delaware River at that point was calculated to be 278 mgd (Table 2.15). This deficiency did not exist in the year 2003. Figure 2.33 corresponds to the analysis shown in Table 2.15 and shows that the deficit is between the Lehigh River and Assunipink Creek on the Delaware.

In 2030 on the Schuylkill River, the number of deficient withdrawal points for the power sector increased to three from the one deficient withdrawal point identified in year 2003. The total deficiency at all three withdrawal points at the downstream end of the Schuylkill was calculated to be 518 mgd (Table 2.16). This was an increase of 428 mgd over the year 2003 results for the Schuylkill River. Figure 2.34 corresponds to the analysis shown in Table 2.16. As the figure shows, 418 mgd of the 518mgd deficit was in Reach 2 between the Tulpehocken and Perkiomen Creeks. The remaining 100 mgd deficit was from withdrawal points downstream of the Perkiomen Creek which did not have any withdrawal points in deficit in the year 2003 as shown in Figure 2.34. Also, in comparing Figure 2.33 to Figure 2.34 it can be seen that the deficit in Reach 2 increased 328 mgd from its 2003 level.

The Lehigh River did not have any deficient withdrawal points projected in the year 2030 (Table 2.17) as it did in year 2003. Therefore, it can be concluded that based on this analysis there is sufficient water in the Lehigh River in order to keep utilization at each withdrawal point below the threshold value of 75% of the natural  $Q_{7-10}$  in the year 2003 and projected in the year 2030.

Table 2.15  
Delaware River Year 2030 Projected Water Supply Conditions

Map ID	Water Use Type	Natural Q710 for Year 2030 (mgd)	Projected Cumul. Consumptive Use Above Withdrawal Point for Year 2030 (mgd)	Projected Withdrawal at Point for Year 2030 (mgd)	Withdrawal as Percentage of Natural Q710 (mgd)	Additional Flow Needed to Lower Utilization Below 75% for Power Sector (mgd)	Additional Flow Needed to Lower Utilization Below 75% for Other Sectors (mgd)
<b>USGS GAGE @ DELAWARE WATER GAP</b>							
40	GOLF	929.45	0.00	0.44	0.05	0.00	0.00
<b>BRODHEAD CREEK</b>							
3	PWR	1058.36	0.39	614.71	58.10	0.00	0.00
80	MANUF	1061.85	2.97	1.45	0.14	0.00	0.00
5	PWR	1104.96	3.41	0.00	0.00	0.00	0.00
6	PWR	1104.96	3.41	15.00	1.36	0.00	0.00
23	PWR	1104.96	7.39	2.04	0.19	0.00	0.00
83	RES. INTAKE	1104.96	8.24	0.00	0.00	0.00	0.00
41	PWS	1126.12	8.24	7.84	0.70	0.00	0.00
<b>LEHIGH RIVER</b>							
75	MANUF	1552.17	13.39	0.00	0.00	0.00	0.00
72	PWR	1552.17	13.39	3.11	0.20	0.00	0.00
90	AG	1552.17	13.96	0.00	0.00	0.00	0.00
91	AG	1552.17	13.96	0.00	0.00	0.00	0.00
34	PWS	1600.56	13.96	18.80	1.18	0.00	0.00
<b>TOHICKON CREEK</b>							
46	PWS	1600.56	15.84	24.80	1.57	0.00	0.00
<b>DELAWARE &amp; RARITAN CANAL - NODE 82 WITHDRAWAL</b>							
82	PWS	1601.23	18.32	100.96	6.38	0.00	0.00
42	PWS	1622.61	119.28	0.01	0.00	0.00	0.00
88	PWS	1644.14	119.29	29.69	1.95	0.00	0.00
36	PWS	1644.14	119.29	3.18	0.21	0.00	0.00
<b>USGS GAGE AT TRENTON</b>							
35	PWS	1644.19	122.25	3.00	0.20	0.00	0.00
<b>ASSUNIPINK CREEK</b>							
1	PWR	<b>1673.60</b>	<b>122.55</b>	<b>1364.69</b>	<b>87.99</b>	<b>277.64</b>	<b>0.00</b>
22	PWR	1714.56	130.34	4.30	0.27	0.00	0.00
44	COMM	1714.56	131.88	43.50	2.75	0.00	0.00
14	PWR	1714.76	136.23	95.87	6.07	0.00	0.00
38	PWS	1714.76	137.55	7.93	0.50	0.00	0.00
37	PWS	1730.58	138.34	5.95	0.37	0.00	0.00



Table 2.15  
Delaware River Year 2030 Projected Water Supply Conditions (Continued)

Map ID	Water Use Type	Natural Q710 for Year 2030 (mgd)	Projected Cumul. Consumptive Use Above Withdrawal Point for Year 2030 (mgd)	Projected Withdrawal at Point for Year 2030 (mgd)	Withdrawal as Percentage of Natural Q710 (mgd)	Additional Flow Needed to Lower Utilization Below 75% for Power Sector (mgd)	Additional Flow Needed to Lower Utilization Below 75% for Other Sectors (mgd)
87	PWS	1730.59	138.93	0.00	0.00	0.00	0.00
33	MANUF	1731.40	138.93	0.40	0.02	0.00	0.00
86	PWS	1743.48	138.97	2.18	0.14	0.00	0.00
73	PWR	1744.42	139.19	0.00	0.00	0.00	0.00
<b>NESHAMINY CREEK</b>							
39	PWS	1891.44	139.19	140.83	8.04	0.00	0.00
89	PWS	1893.41	153.27	18.07	1.04	0.00	0.00
45	MANUF	1911.60	155.08	0.77	0.04	0.00	0.00
84	MANUF	1921.94	155.08	0.16	0.01	0.00	0.00
30	MANUF	1921.94	155.10	10.28	0.58	0.00	0.00
74	MINING	1931.18	156.13	0.00	0.00	0.00	0.00
8	PWR	1933.25	156.13	0.00	0.00	0.00	0.00
18	PWR	1951.40	156.13	30.89	1.72	0.00	0.00
77	MANUF	1951.41	156.29	0.00	0.00	0.00	0.00
78	MANUF	1951.42	156.29	0.00	0.00	0.00	0.00
79	MANUF	1951.42	156.29	0.00	0.00	0.00	0.00
<b>SCHUYLKILL RIVER</b>							
<b>TOTALS</b>			<b>156.29</b>	<b>2550.83</b>		<b>277.64</b>	<b>0.00</b>

*Bold values denote where utilization exceeds 75%*

*Consumptive Use, Withdrawals, and Q710 Values from Year 2030*

*Q710 Values Reduced by 5% from 2003 Values to Account for Climate Variability in Year 2030*

Table 2.16  
Schuylkill River Year 2030 Projected Water Supply Conditions

Map ID	Water Use Type	Natural Q710 for Year 2030 (mgd)	Projected Cumul. Consumptive Use Above Withdrawal Point for Year 2030 (mgd)	Projected Withdrawal at Point for Year 2030 (mgd)	Withdrawal as Percentage of Natural Q710 (mgd)	Additional Flow Needed to Lower Utilization Below 75% for Power Sector (mgd)	Additional Flow Needed to Lower Utilization Below 75% for Other Sectors (mgd)
54	AG	57.89	0.00	0.00	0.00	0.00	0.00
68	MANUF	57.97	0.00	0.00	0.00	0.00	0.00
<b>MIADEN CREEK</b>							
63	MANUF	88.52	0.00	0.34	0.39	0.00	0.00
4	PWR	91.91	0.03	33.82	36.81	0.00	0.00
<b>TULPEHOCKEN CREEK - BLUE MARSH RESERVOIR</b>							
<b>USGS GAGE AT READING</b>							
67	PWS	144.97	2.94	4.78	3.37	0.00	0.00
<b>MANATAWNY CREEK</b>							
<b>USGS GAGE AT POTTSTOWN</b>							
55	MANUF	158.92	3.42	0.12	0.07	0.00	0.00
11	PWR	161.49	3.43	84.41	53.40	0.00	0.00
64	PWS	164.31	70.01	2.71	2.87	0.00	0.00
58	PWS	167.18	70.28	3.67	3.78	0.00	0.00
7	<b>PWR</b>	<b>167.22</b>	<b>70.65</b>	<b>384.20</b>	<b>397.84</b>	<b>418.26</b>	<b>0.00</b>
62	PWS	178.73	72.76	27.28	25.74	0.00	0.00
<b>PERKIOMEN CREEK</b>							
60	PWS	244.53	75.48	11.87	7.02	0.00	0.00
<b>USGS GAGE AT NORRISTOWN</b>							
61	MANUF	245.90	76.67	0.27	0.16	0.00	0.00
56	MANUF	258.59	76.70	6.31	3.47	0.00	0.00
<b>WISSAHICKON CREEK</b>							
65	PWS	260.85	76.77	76.09	41.34	0.00	0.00
66	PWS	261.21	152.86	49.67	45.84	0.00	0.00
<b>USGS GAGE AT PHILADELPHIA</b>							
20	<b>PWR</b>	<b>262.14</b>	<b>202.53</b>	<b>71.28</b>	<b>119.59</b>	<b>35.91</b>	<b>0.00</b>
69	PWR	262.14	202.64	11.18	18.78	0.00	0.00
10	<b>PWR</b>	<b>262.14</b>	<b>203.36</b>	<b>91.64</b>	<b>155.89</b>	<b>64.01</b>	<b>0.00</b>
59	MANUF	263.59	203.66	2.08	3.47	0.00	0.00
57	MANUF	263.70	204.25	8.25	13.88	0.00	0.00
<b>DELAWARE RIVER</b>							
<b>TOTALS</b>			<b>204.25</b>	<b>869.98</b>		<b>518.18</b>	<b>0.00</b>

*Bold values denote where utilization exceeds 75%*

*Consumptive Use, Withdrawals, and Q710 Values from Year 2030*

*Q710 Values Reduced by 5% from 2003 Values to Account for Climate Variability in Year 2030*

Table 2.17 Lehigh River Year 2030 Water Supply Conditions

Map ID	Water Use Type	Natural Q710 for Year 2030 (mgd)	Projected Cumul. Consumptive Use Above Withdrawal Point for Year 2030 (mgd)	Projected Withdrawal at Point for Year 2030 (mgd)	Withdrawal as Percentage of Natural Q710 (mgd)	Additional Flow Needed to Lower Utilization Below 75% for Power Sector(mgd)	Additional Flow Needed to Lower Utilization Below 75% for Other Sectors(mgd)
49	GOLF	3.53	0.00	0.00	0.00	0.00	0.00
<b>FE WALTER RESERVOIR</b>							
50	PWR	82.59	0.00	0.00	0.00	0.00	0.00
52	MANUF	135.30	0.00	0.00	0.00	0.00	0.00
<b>USGS GAGE AT LEHIGHTON</b>							
<b>POHOPOCO CREEK - BELTZVILLE RESERVOIR</b>							
47	PWR	218.24	0.00	3.14	1.44	0.00	0.00
51	PWR	218.59	0.31	0.57	0.26	0.00	0.00
19	PWR	218.70	0.37	2.39	1.09	0.00	0.00
48	RES. INTAKE	218.70	2.76	0.00	0.00	0.00	0.00
<b>JORDAN CREEK</b>							
53	PWS	284.16	2.76	0.09	0.03	0.00	0.00
<b>USGS GAGE AT BETHLEHEM</b>							
24	PWR	297.75	2.77	2.33	0.79	0.00	0.00
<b>DELAWARE RIVER</b>							
<b>TOTALS</b>			<b>2.77</b>	<b>8.52</b>		<b>0.00</b>	<b>0.00</b>

*Consumptive Use, Withdrawals, and Q710 Values from Year 2030*

*Q710 Values Reduced by 5% from 2003 Values to Account for Climate Variability in Year 2030*

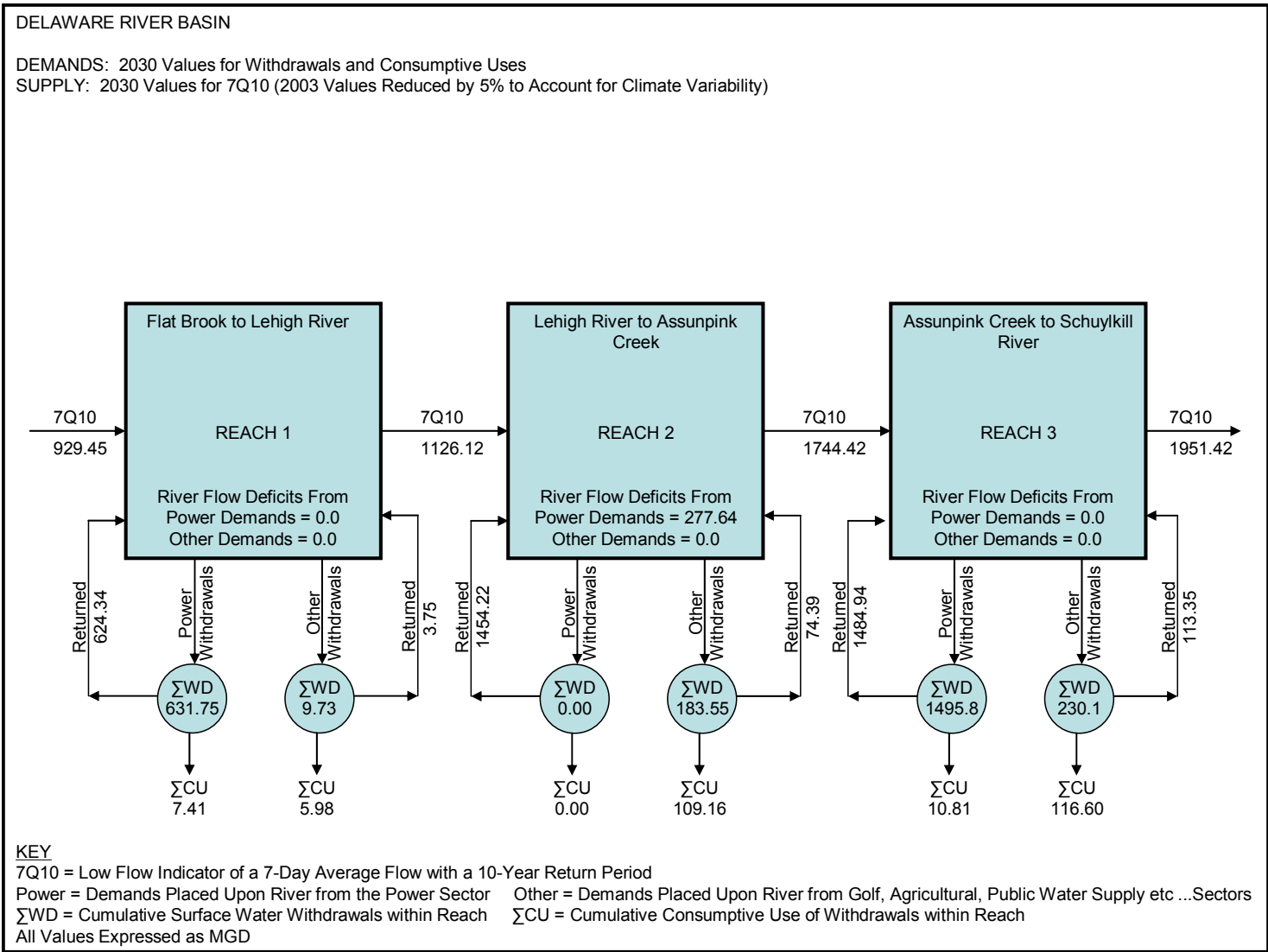

Figure 2.33: Delaware River Year 2030 Water Supply Conditions

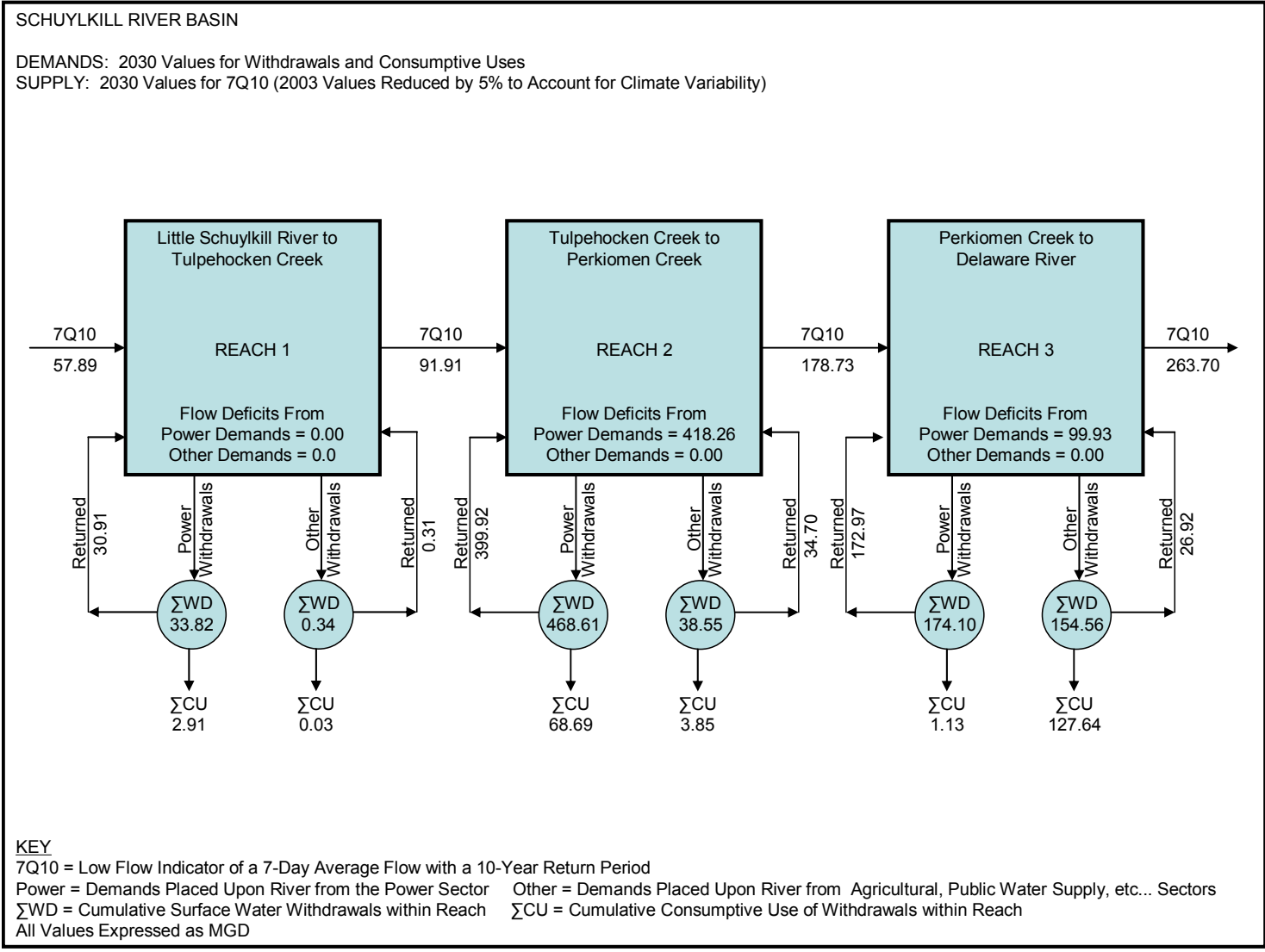

Figure 2.34: Schuylkill River Year 2030 Water Supply Conditions

**2.3.2.3 Deficiencies Under Drought Conditions** Along with calculating deficiencies on the rivers in the years 2003 and 2030, deficiencies were also calculated for several alternatives that assumed reduced Q<sub>7</sub>10 flows to simulate “drought-like” conditions. This analysis was done to check the sensitivity of the results to variable levels of water availability. The Q<sub>7</sub>10 calculated for the year 2003 was reduced by 25%, 50%, and 75% on the Delaware River and was reduced by 25%, and 50% for the Schuylkill and Lehigh Rivers. Withdrawals and consumptive use values projected for the year 2030 were also used in drought sensitivity analysis. Tables 2.18-2.20 summarize the Q<sub>7</sub>10 at each withdrawal point for the various reductions made at the Delaware, Schuylkill and Lehigh Rivers, respectively.

This sensitivity analysis was not intended to serve as a comprehensive drought analysis for the rivers nor were they intended to represent flows along the rivers corresponding to the 1960s drought of record. The Q<sub>7</sub>10 and reductions of it were intended to serve as a screening parameter at a reconnaissance level to see what if any alternative sources of water would be needed.

The results of the drought sensitivity analysis showed that when the Q<sub>7</sub>10 was reduced by 50% on the Delaware River, the number of withdrawal points in deficit increased along with the total magnitude of the deficit at the downstream end of the analysis. Table 2.21 shows that by reducing the Q<sub>7</sub>10 on the Delaware River by 50%, flow at two withdrawal points is deficient and the total deficit at the downstream end of the analysis is 1337 mgd. Previously, Table 2.12 showed no deficit on the Delaware River in year 2003. The corresponding graphic to Table 2.21 is shown in Figure 2.35.

Reducing the Q<sub>7</sub>10 on the Schuylkill River by 50% also increased the deficit on the river as shown in Table 2.21. The total deficit on the Schuylkill River increased from 90 mgd in 2003 to 1096 mgd. The 50% reduction in Q<sub>7</sub>10 also resulted in other withdrawal points being deficient other than the ones for the power sector. Approximately, 139 mgd of the 1096 mgd total was attributable to sectors other than the power sector. The remaining 957 mgd came from the power sector and was an increase of 867 mgd from the 2003 levels. Figure 2.36 corresponds to the analysis shown in Table 2.22.

On the Lehigh River, reducing the Q<sub>7</sub>10 by 50% did not reduce the flow enough so that a withdrawal point was identified as being deficient. Table 2.23 shows that even when the Q<sub>7</sub>10 was reduced by 50%, no additional flow was needed at the withdrawal points.

Similar tables and figures for the 25% and 75% reductions done in the drought sensitivity analysis are presented in Technical Appendix A.

Table 2.18  
Delaware River Q<sub>7</sub>10 with Reductions

Map ID	Vicinity of	2003 (mgd)	Reduction of 2003 Q <sub>7</sub> 10 (mgd) by:			
			5% (2030)	25%	50%	75%
40	Brodhead Creek	978.37	929.45	733.78	489.18	244.59
3		1114.06	1058.36	835.55	557.03	278.52
80		1117.74	1061.85	838.31	558.87	279.44
5		1163.12	1104.96	872.34	581.56	290.78
6		1163.12	1104.96	872.34	581.56	290.78
23		1163.12	1104.96	872.34	581.56	290.78
83		1163.12	1104.96	872.34	581.56	290.78
41	Lehigh River	1185.39	1126.12	889.04	592.70	296.35
75		1633.87	1552.17	1225.40	816.93	408.47
72		1633.87	1552.17	1225.40	816.93	408.47
90		1633.87	1552.17	1225.40	816.93	408.47
91		1633.87	1552.17	1225.40	816.93	408.47
34		1684.80	1600.56	1263.60	842.40	421.20
46	Tohickon Creek	1684.80	1600.56	1263.60	842.40	421.20
82	D&R Canal	1685.50	1601.23	1264.13	842.75	421.38
42		1708.01	1622.61	1281.01	854.01	427.00
88		1730.67	1644.14	1298.00	865.33	432.67
36		1730.67	1644.14	1298.00	865.33	432.67
35	USGS Gage at Trenton	1730.72	1644.19	1298.04	865.36	432.68
1		1761.68	1673.60	1321.26	880.84	440.42
22		1804.79	1714.56	1353.60	902.40	451.20
44		1804.79	1714.56	1353.60	902.40	451.20
14		1805.01	1714.76	1353.76	902.51	451.25
38		1805.01	1714.76	1353.76	902.51	451.25
37		1821.66	1730.58	1366.25	910.83	455.42
87		1821.67	1730.59	1366.26	910.84	455.42
33		1822.53	1731.40	1366.89	911.26	455.63
86		1835.24	1743.48	1376.43	917.62	458.81
73	Neshaminy Creek	1836.23	1744.42	1377.17	918.11	459.06
39		1990.99	1891.44	1493.24	995.49	497.75
89		1993.07	1893.41	1494.80	996.53	498.27
45		2012.21	1911.60	1509.15	1006.10	503.05
84		2023.09	1921.94	1517.32	1011.55	505.77
30		2023.09	1921.94	1517.32	1011.55	505.77
74		2032.82	1931.18	1524.62	1016.41	508.21
8		2035.00	1933.25	1526.25	1017.50	508.75
18		2054.11	1951.40	1540.58	1027.05	513.53
77		2054.12	1951.41	1540.59	1027.06	513.53
78		2054.13	1951.42	1540.60	1027.07	513.53
79	Schuylkill River	2054.13	1951.42	1540.60	1027.07	513.53

Table 2.19  
Schuylkill River Q<sub>7</sub>10 with Reductions

Map ID	Vicinity of	2003 (mgd)	Reductions of Q <sub>7</sub> 10 (mgd) by:		
			5% (2030)	25%	50%
54		60.94	57.89	45.70	30.47
63	Maiden Creek	61.02	57.97	45.76	30.51
68		93.18	88.52	69.88	46.59
4	Tulpehocken Creek	96.75	91.91	72.56	48.37
67	Manatawny Creek	152.60	144.97	114.45	76.30
55	USGS Gage at Pottstown	167.28	158.92	125.46	83.64
11		169.99	161.49	127.49	84.99
64		172.96	164.31	129.72	86.48
58		175.98	167.18	131.98	87.99
7		176.02	167.22	132.01	88.01
62	Perkiomen Creek	188.14	178.73	141.10	94.07
60		257.40	244.53	193.05	128.70
61		258.84	245.90	194.13	129.42
56		272.20	258.59	204.15	136.10
65	Wissahickon Creek	274.57	260.85	205.93	137.29
66		274.96	261.21	206.22	137.48
20	USGS Gage at Phila.	275.94	262.14	206.95	137.97
69		275.94	262.14	206.95	137.97
10		275.94	262.14	206.95	137.97
59		277.46	263.59	208.10	138.73
57	Delaware River	277.58	263.70	208.19	138.79

Table 2.20  
Lehigh River Q<sub>7</sub>10 with Reductions

Map ID	Vicinity of	2003 (mgd)	Reduction of Q <sub>7</sub> 10 (mgd) by:		
			5% (2030)	25%	50%
49	Upstream of FE Walter Res.	3.72	3.53	2.79	1.86
50		86.94	82.59	65.21	43.47
52	USGS Gage at Lehighton	142.42	135.30	106.82	71.21
47		229.73	218.24	172.30	114.87
51		230.09	218.59	172.57	115.05
19	Hokendauqua Creek	230.21	218.70	172.66	115.11
48	Jordan Creek	230.21	218.70	172.66	115.11
53		299.12	284.16	224.34	149.56
24	Saucon Creek	313.42	297.75	235.07	156.71



Table 2.21  
Water Supply Conditions on the Delaware River when Q<sub>7</sub>10 Reduced by 50%

Map ID	Water Use Type	50% Reduction in Natural Q <sub>7</sub> 10 (mgd)	Projected Cumul. Consumptive Use Above Withdrawal Point for Year 2030 (mgd)	Projected Withdrawal at Point for Year 2030 (mgd)	Withdrawal as Percentage of Natural Q <sub>7</sub> 10 (mgd)	Additional Flow Needed to Lower Utilization Below 75% for Power Sector (mgd)	Additional Flow Needed to Lower Utilization Below 75% for Other Sectors (mgd)
<b>USGS GAGE @ DELAWARE WATER GAP</b>							
40	GOLF	489.18	0.00	0.44	0.09	0.00	0.00
<b>BRODHEAD CREEK</b>							
3	PWR	557.03	0.39	614.71	110.43	267.07	0.00
80	MANUF	1061.85	2.97	1.45	0.14	0.00	0.00
5	PWR	1104.96	3.41	0.00	0.00	0.00	0.00
6	PWR	1104.96	3.41	15.00	1.36	0.00	0.00
23	PWR	1104.96	7.39	2.04	0.19	0.00	0.00
83	RES.	581.56	8.24	0.00	0.00	0.00	0.00
41	INTAKE PWS	592.70	8.24	7.84	1.34	0.00	0.00
<b>LEHIGH RIVER</b>							
75	MANUF	816.93	13.39	0.00	0.00	0.00	0.00
72	PWR	1552.17	13.39	3.11	0.20	0.00	0.00
90	AG	1552.17	13.96	0.00	0.00	0.00	0.00
91	AG	1552.17	13.96	0.00	0.00	0.00	0.00
34	PWS	842.40	13.96	18.80	2.27	0.00	0.00
<b>TOHICKON CREEK</b>							
46	PWS	842.40	15.84	24.80	3.00	0.00	0.00
<b>DELAWARE &amp; RARITAN CANAL - NODE 82 WITHDRAWAL</b>							
82	PWS	842.75	18.32	100.96	12.25	0.00	0.00
42	PWS	854.01	119.28	0.01	0.00	0.00	0.00
88	PWS	865.33	119.29	29.69	3.98	0.00	0.00
36	PWS	865.33	119.29	3.18	0.43	0.00	0.00
<b>USGS GAGE AT TRENTON</b>							
35	PWS	865.36	122.25	3.00	0.40	0.00	0.00
<b>ASSUNIPINK CREEK</b>							
1	PWR	880.84	122.55	1364.69	179.97	1070.40	0.00

Table 2.21  
 Water Supply Conditions on the Delaware River when Q<sub>7</sub>10 Reduced by 50%  
 (Continued)

Map ID	Water Use Type	50% Reduction in Natural Q <sub>7</sub> 10 (mgd)	Projected Cumul. Consumptive Use Above Withdrawal Point for Year 2030 (mgd)	Projected Withdrawal at Point for Year 2030 (mgd)	Withdrawal as Percentage of Natural Q <sub>7</sub> 10 (mgd)	Additional Flow Needed to Lower Utilization Below 75% for Power Sector (mgd)	Additional Flow Needed to Lower Utilization Below 75% for Other Sectors (mgd)
22	PWR	902.40	130.34	4.30	0.56	0.00	0.00
44	COMM	1714.56	131.88	43.50	2.75	0.00	0.00
14	PWR	1714.76	136.23	95.87	6.07	0.00	0.00
38	PWS	1714.76	137.55	7.93	0.50	0.00	0.00
37	PWS	1730.58	138.34	5.95	0.37	0.00	0.00
87	PWS	1730.59	138.93	0.00	0.00	0.00	0.00
33	MANUF	1731.40	138.93	0.40	0.02	0.00	0.00
86	PWS	917.62	138.97	2.18	0.28	0.00	0.00
73	PWR	918.11	139.19	0.00	0.00	0.00	0.00
<b>NESHAMINY CREEK</b>							
39	PWS	995.49	139.19	140.83	16.45	0.00	0.00
89	PWS	996.53	153.27	18.07	2.14	0.00	0.00
45	MANUF	1911.60	155.08	0.77	0.04	0.00	0.00
84	MANUF	1921.94	155.08	0.16	0.01	0.00	0.00
30	MANUF	1921.94	155.10	10.28	0.58	0.00	0.00
74	MINING	1931.18	156.13	0.00	0.00	0.00	0.00
8	PWR	1933.25	156.13	0.00	0.00	0.00	0.00
18	PWR	1951.40	156.13	30.89	1.72	0.00	0.00
77	MANUF	1951.41	156.29	0.00	0.00	0.00	0.00
78	MANUF	1027.07	156.29	0.00	0.00	0.00	0.00
79	MANUF	1027.07	156.29	0.00	0.00	0.00	0.00
<b>SCHUYLKILL RIVER</b>							
<b>TOTALS</b>			<b>156.29</b>	<b>2550.83</b>		<b>1337.47</b>	<b>0.00</b>

Table 2.22  
Water Supply Conditions on the Schuylkill River when Q710 Reduced by 50%

Map ID	Water Use Type	50% Reduction in Natural Q <sub>710</sub> (mgd)	Projected Cumul. Consumptive Use Above Withdrawal Point for Year 2030 (mgd)	Projected Withdrawal at Point for Year 2030 (mgd)	Withdrawal as Percentage of Natural Q <sub>710</sub> (mgd)	Additional Flow Needed to Lower Utilization Below 75% for Power Sector (mgd)	Additional Flow Needed to Lower Utilization Below 75% for Other Sectors (mgd)
54	AG	30.47	0.00	0.00	0.00	0.00	0.00
68	MANUF	30.51	0.00	0.00	0.00	0.00	0.00
<b>MAIDEN CREEK</b>							
63	MANUF	46.59	0.00	0.34	0.74	0.00	0.00
4	PWR	48.37	0.03	33.82	69.96	0.00	0.00
<b>TULPEHOCKEN CREEK</b>							
<b>USGS GAGE AT READING</b>							
67	PWS	76.30	2.94	4.78	6.52	0.00	0.00
<b>MANATAWNY CREEK</b>							
<b>USGS GAGE AT POTTSTOWN</b>							
55	MANUF	83.64	3.42	0.12	0.15	0.00	0.00
11	<b>PWR</b>	<b>84.99</b>	3.43	84.41	<b>103.49</b>	<b>31.54</b>	<b>0.00</b>
64	PWS	86.48	70.01	2.71	16.46	0.00	0.00
58	PWS	87.99	70.28	3.67	20.70	0.00	0.00
7	<b>PWR</b>	<b>88.01</b>	<b>70.65</b>	<b>384.20</b>	<b>2212.75</b>	<b>497.46</b>	<b>0.00</b>
62	<b>PWS</b>	<b>94.07</b>	72.76	27.28	<b>128.00</b>	<b>0.00</b>	<b>15.24</b>
<b>PERKIOMEN CREEK</b>							
60	PWS	128.70	75.48	11.87	22.31	0.00	0.00
<b>USGS GAGE AT NORRISTOWN</b>							
61	MANUF	129.42	76.67	0.27	0.51	0.00	0.00
56	MANUF	136.10	76.70	6.31	10.63	0.00	0.00
<b>WISSAHICKON CREEK</b>							
65	<b>PWS</b>	<b>137.29</b>	76.77	76.09	<b>125.74</b>	<b>0.00</b>	<b>41.45</b>
66	<b>PWS</b>	<b>137.48</b>	152.86	49.67	<b>-322.81</b>	<b>0.00</b>	<b>81.94</b>
<b>USGS GAGE AT PHILADELPHIA</b>							
20	<b>PWR</b>	<b>137.97</b>	<b>202.53</b>	<b>71.28</b>	<b>-110.41</b>	<b>160.09</b>	<b>0.00</b>
69	<b>PWR</b>	<b>137.97</b>	202.64	11.18	<b>-17.28</b>	<b>79.65</b>	<b>0.00</b>
10	<b>PWR</b>	<b>137.97</b>	<b>203.36</b>	<b>91.64</b>	<b>-140.14</b>	<b>188.18</b>	<b>0.00</b>
59	MANUF	138.73	203.66	2.08	-3.20	0.00	0.00
57	MANUF	138.79	204.25	8.25	-12.61	0.00	0.00
<b>DELAWARE RIVER</b>							
<b>TOTALS</b>			<b>204.25</b>	<b>869.98</b>		<b>956.93</b>	<b>138.63</b>

Table 2.23  
Water Supply Conditions on the Lehigh River when Q<sub>710</sub> Reduced by 50%

Map ID	Water Use Type	50% of Natural Q <sub>710</sub> (mgd)	Projected Cumul. Consumptive Use Above Withdrawal Point for Year 2030 (mgd)	Projected Withdrawal at Point for Year 2030 (mgd)	Withdrawal as Percentage of Natural Q <sub>710</sub> (mgd)	Additional Flow Needed to Lower Utilization Below 75% for Power Sector (mgd)	Additional Flow Needed to Lower Utilization Below 75% for Other Sectors (mgd)
49	GOLF	1.86	0.00	0.00	0.00	0.00	0.00
<b>FE WALTER RESERVOIR</b>							
50	PWR	43.47	0.00	0.00	0.00	0.00	0.00
52	MANUF	71.21	0.00	0.00	0.00	0.00	0.00
<b>USGS GAGE AT LEHIGHTON</b>							
<b>POHOPOCO CREEK - BELTZVILLE RESERVOIR</b>							
47	PWR	114.87	0.00	3.14	2.74	0.00	0.00
51	PWR	115.05	0.31	0.57	0.49	0.00	0.00
19	PWR	115.11	0.37	2.39	2.08	0.00	0.00
48	RES. INTAKE	115.11	2.76	0.00	0.00	0.00	0.00
<b>JORDAN CREEK</b>							
53	PWS	149.56	2.76	0.09	0.06	0.00	0.00
<b>USGS GAGE AT BETHLEHEM</b>							
24	PWR	156.71	2.77	2.33	1.51	0.00	0.00
<b>DELAWARE RIVER</b>							
<b>TOTALS</b>			<b>2.77</b>	<b>8.52</b>		<b>0.00</b>	<b>0.00</b>

DELAWARE RIVER BASIN

DEMANDS: 2030 Values for Withdrawals and Consumptive Uses  
 SUPPLY: 50% Reduction of Natural 7Q10 from Year 2003

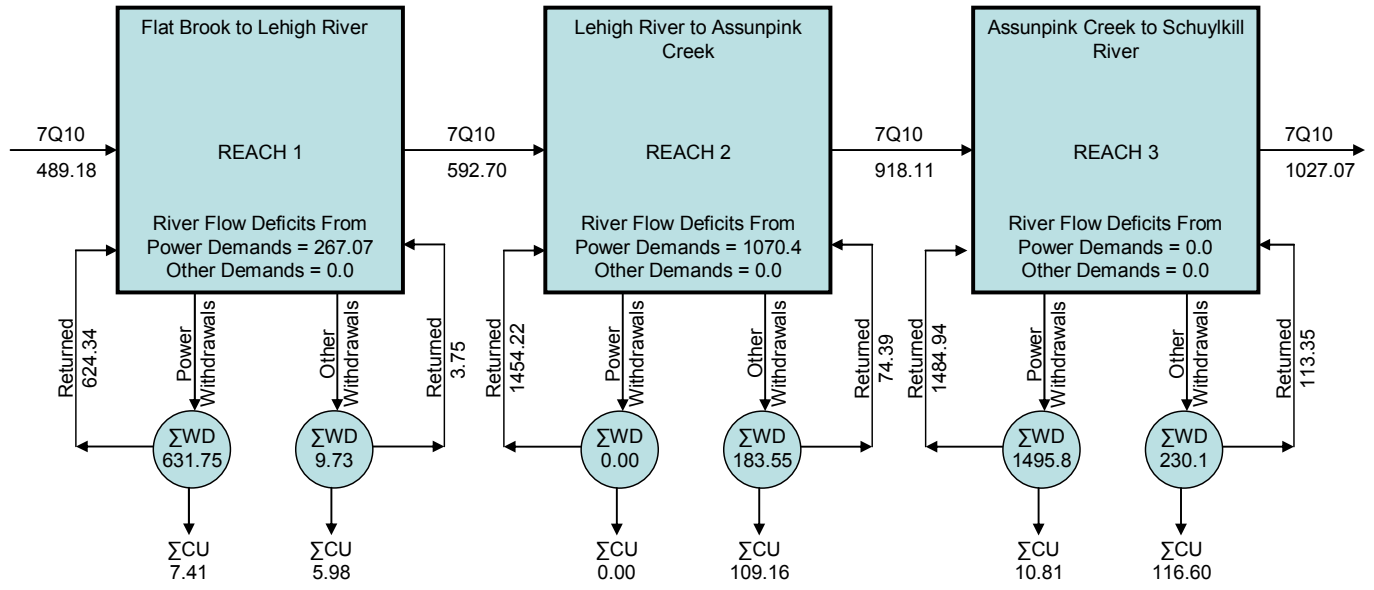

KEY

7Q10 = Low Flow Indicator of a 7-Day Average Flow with a 10-Year Return Period

Power = Demands Placed Upon River from the Power Sector    Other = Demands Placed Upon River from Golf, Agricultural, Public Water Supply etc ...Sectors

ΣWD = Cumulative Surface Water Withdrawals within Reach    ΣCU = Cumulative Consumptive Use of Withdrawals within Reach

All Values Expressed as MGD

Figure 2.35 Water Supply Conditions on the Delaware River when Q710 Reduced by 50%

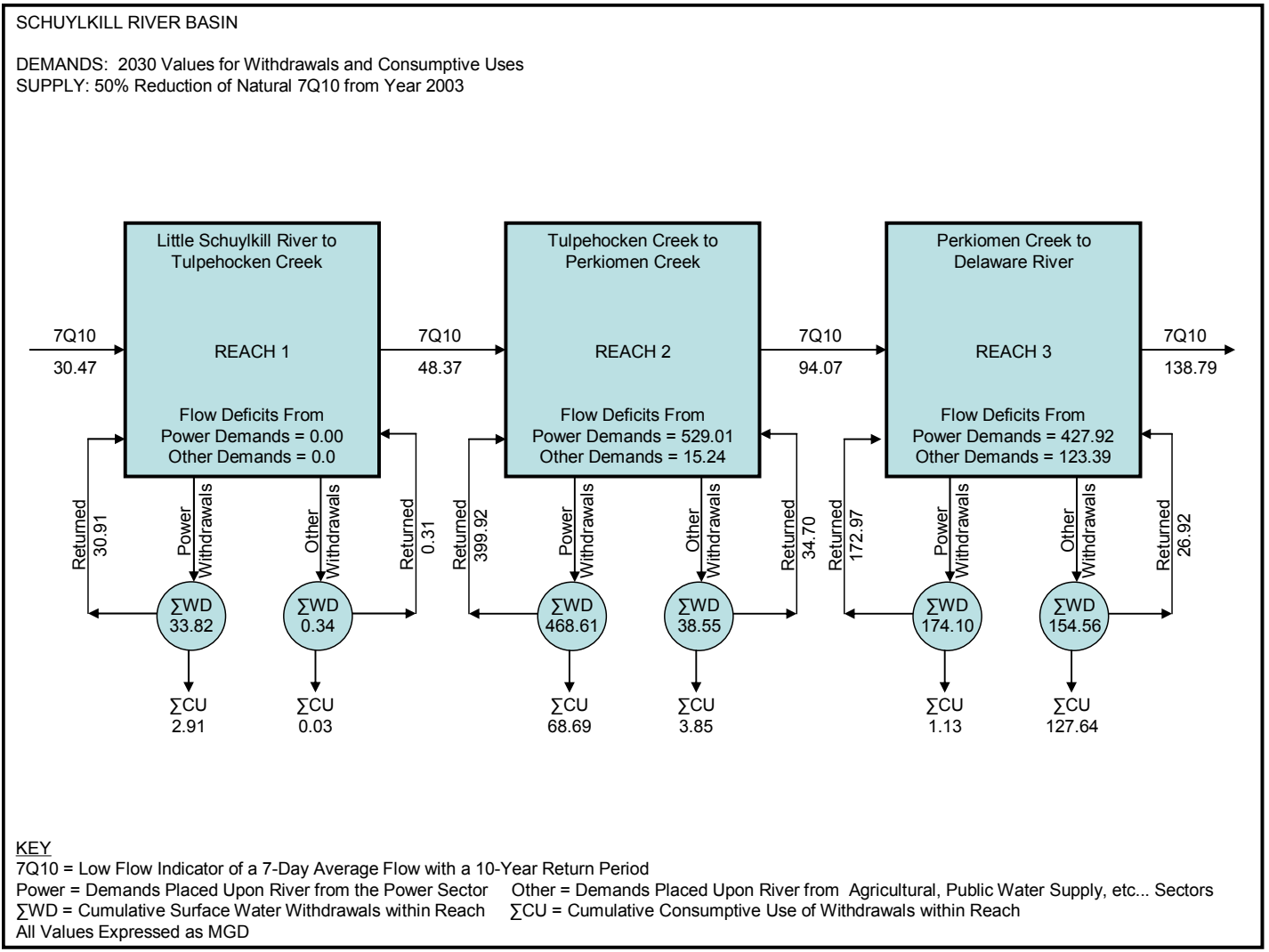

Figure 2.36 Water Supply Conditions on the Schuylkill River when Q<sub>7</sub>10 Reduced by 50%

## **2.4 POTENTIAL ALTERNATIVES FOR WATER SUPPLY**

Several alternatives were examined that could potentially meet the surface and groundwater deficiencies previously identified in watersheds identified for further study and along the Schuylkill and Delaware Rivers. Potential solutions were divided into two parts; expand supply alternatives and curtail demand alternatives.

Alternatives that expanded supply included such things as: aquifer storage and recovery (ASR), expansion of municipal systems, reuse of waste and storm water, mine reclamation, desalination, river diversions, and reservoir storage, Alternatives that curtail demand include: improved water accountability with reduced infrastructure losses, additional conservation, change water allocations, new regulations, and improved irrigation techniques.

Only two alternatives were examined in detail that could meet the water supply deficiencies outlined previously in the Basin. The alternatives examined in detail were diverting water from the Delaware River and reservoir storage in the Schuylkill River Basin. It was beyond the scope of this report to examine each alternative in detail. It is recommended that all of these alternatives and others not mentioned be examined in detail in a comprehensive Basin-wide water supply “feasibility-level” study. A brief description of each alternative follows.

### **2.4.1 Expand Supply Alternatives.**

**2.4.1.1 Aquifer Storage and Recovery (ASR).** ASR involves injecting water into an aquifer through wells or by surface spreading and infiltration and then pumping it out when needed. Essentially the aquifer functions as a “water bank”. Water is injected in times of surplus when precipitation is high and is pumped out of the aquifer during times when available water is low and demand is high which is typically in the summer. Artesian Water Company in the State of Delaware currently operates ASR wellfields and is in the process of expanding the use of them in order to increase water supply in Delaware. One possible alternative that could meet the previously identified deficits in watershed DB-127 could be Delaware’s expanded ASR program.

**2.4.1.2 Expansion of Municipal Systems.** Expansion of Municipal System involves interconnections between multiple water distribution systems to cover a larger geographical area and also involves expanding water distribution systems to areas that are serviced by wells. The concept behind this alternative is moving water from areas where it is more plentiful to areas where water availability is limited. Interconnections between systems that are operated by different purveyors are currently being done in some areas of need in the State of New Jersey, for example.

**2.4.1.3 Reuse of Waste and Storm Water.** There are a variety of water sources that may be supplied as reuse water, including waste water (from sewerage systems), drainage water, and storm water. Sewerage systems collect and treat waste water to primary, secondary, or tertiary levels. Storm water may also be collected using infrastructure separate to sewerage systems and, depending on its intended use, may or may not be treated before being supplied as reuse water. Drainage water is collected in regional drains managed by irrigation/rural water

providers. This water may be supplied as reuse water to customers or discharged to the environment. Typically this practice has been focused at a very small scale. Potentially reuse of waste and storm water at a watershed scale could make available a large quantity of water to many of the high water-use sectors in the Basin such as power and irrigation.

**2.4.1.4 Mine Reclamation.** What to do with flooded abandoned mines in the State of Pennsylvania has been an ongoing problem for the State. Pennsylvania Department of Environment (PADEP) estimates that there are between 10,000 and 15,000 abandoned underground mines in the state, many of which are within the confines of the Delaware River Basin. Utilization of flooded abandoned mines as an alternative water supply source could potentially augment downstream water supply in the Basin significantly. The practice of using water from a flooded mine is currently being done in the Schuylkill River Basin by Exelon Corporation for their Limerick Generating Station. Exelon is augmenting flows in the Schuylkill River to support the needs of the Limerick Station from the Wadesville mine pool which is located at the Schuylkill River headwaters. Further detailed investigations are needed to see if this practice could be expanded in the Basin.

**2.4.1.5 Desalination.** Treating saline water by either distillation or reverse osmosis is more expensive relatively compared to other alternatives. Typically desalination is only economically practical in arid regions of the world such as in the Middle East. Emerging technologies may make desalination more practical economically and expand its uses as a viable alternative in areas where it was previously dismissed. Further investigation is needed.

**2.4.1.6 Delaware River Diversions.** Diverting river water through pipelines from the Delaware River to other parts of the Basin is currently being implemented and was investigated in further detail as a possible alternative to meeting the watershed deficits calculated in New Jersey and Pennsylvania.

Two existing diversions were utilized in the analysis, New Jersey American Water Company's Tri-County Regional Pipeline and the Point Pleasant Pumping Station. The alternatives investigated in this report was to increase the amount of water that each diversion takes from Delaware River in order to alleviate the deficits projected in year 2030 and potential deficits computed under simulated drought conditions. The increased diversion through the Tri-County Regional Pipeline would address the deficits computed for watersheds DB-90, DB-92, DB-111, DB-137, DB-117, and DB-118 in New Jersey. Water diverted by the Point Pleasant Pumping Station was assumed to alleviate the deficits calculated in watershed DB-108 and the Lower Schuylkill River below Perkiomen Creek in Pennsylvania. Figure 2.37 shows the conceptual plan for these two diversions.

Table 2.24 summarizes the analysis for the Delaware River in the year 2030 with the additional water being diverted from Point Pleasant and the Tri-County Regional Pipeline intakes. The table shows that no additional downstream withdrawal point becomes deficient when Point Pleasant and NJ American's Tri-County Regional Pipeline divert the 213 mgd total in order to meet the projected deficits in 2030 for Pennsylvania and New Jersey respectively. The only deficiency is at withdrawal point #1. The deficiency increased by the 102 mgd that is being diverted upstream of the point at Point Pleasant.



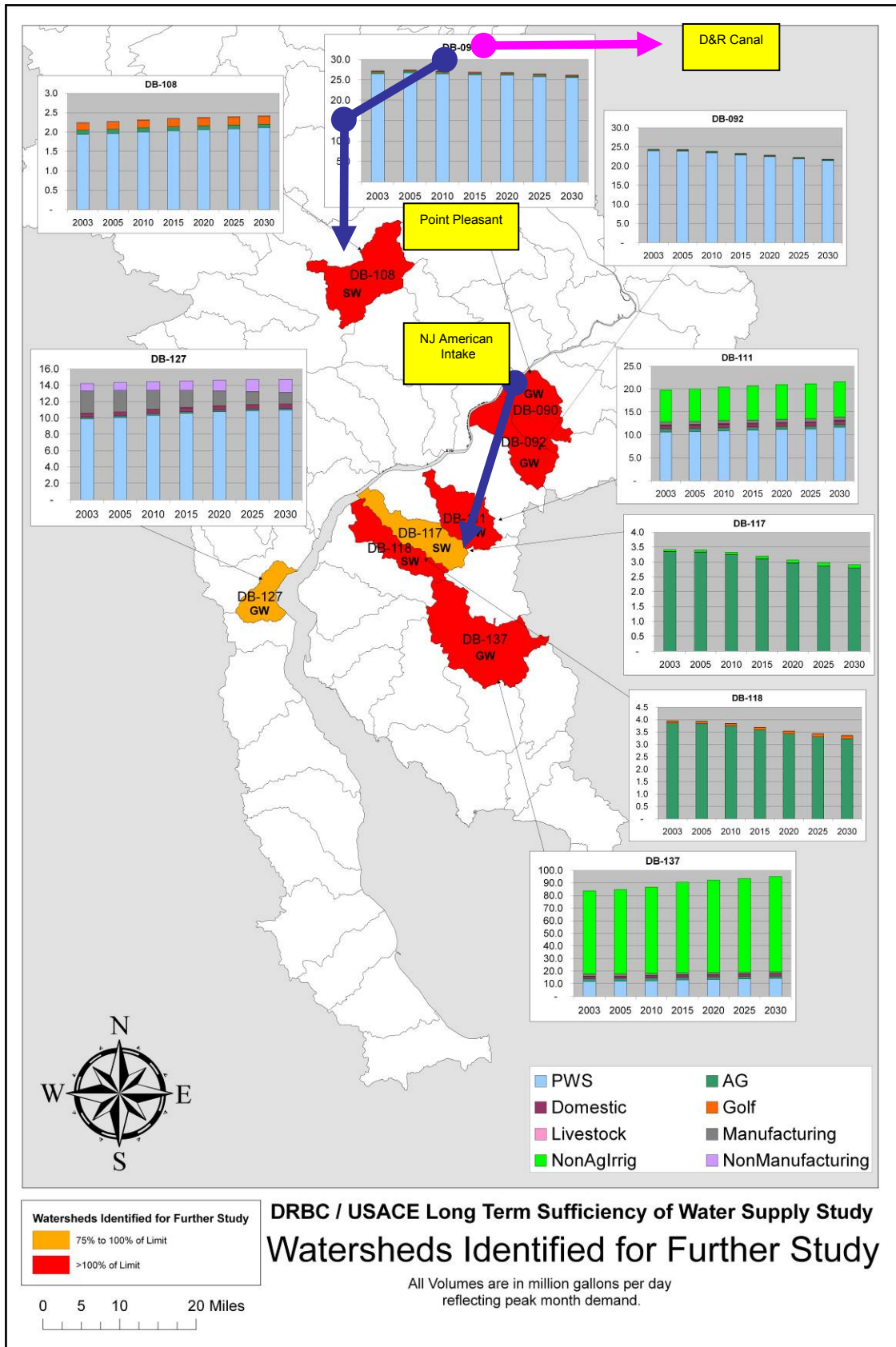

Figure 2.37: Delaware River Diversions Utilized in Analysis

Table 2.25 summarizes a drought sensitivity analysis for the Delaware River. Four parameters were reduced by 50% for this analysis. They were the Q<sub>7</sub>10 in the Delaware River, the Q<sub>7</sub>10 in the previously identified surface water deficient watersheds in New Jersey and Pennsylvania, the 25-year baseflow for the previously identified ground water deficient watersheds in New Jersey, and the Q<sub>7</sub>10 in the Schuylkill River. The consumptive uses and withdrawal quantities were kept at projected 2030 levels for this analysis. Decreasing all of these parameters, increased the total deficit to be met by the Delaware River from 213 mgd to 292 mgd. As the table shows, the increased deficit did not increase the number of downstream withdrawal points on the Delaware as being deficient. Only two points were identified as being deficient, and they were the same two points identified previously in Table 2.21 from the power sector. The magnitude of the deficiency at the two withdrawal points increased from 1337 mgd to 1463 mgd.

Technical Appendix A has additional drought sensitivity analysis tables for the Delaware River that incorporate meeting the needs of the watersheds identified for further study with Delaware River water.

**2.4.1.7 Reservoir Storage in the Delaware River Basin.** The analysis showed no additional reservoir storage was necessary for water supply needs. However, flow augmentation on the Lehigh and Delaware Rivers as a result of modifying the existing FE Walter Reservoir was examined briefly. It was projected that 164 mgd of additional supply over a span of 120 days could be added to the Lehigh and Delaware Rivers from FE Walter Mod. The analysis conducted for this report did not show a need for flow augmentation from FE Walter for water supply, but it should be noted that several factors were not considered in the analysis. First, the analysis was based upon Q<sub>7</sub>10 and not the drought of the record from the 1960s. Q<sub>7</sub>10 flows are higher than the flows experienced during the 1960s drought of record

A comprehensive drought analysis that incorporates the drought of record along with possible synthetic droughts that could be worse than the drought of the record should be conducted. An examination of FE Walter Mod should be done in this comprehensive basin-wide drought analysis. Also, not conducted as part of this analysis was a drought sensitivity analysis of the other 139 watersheds that were not identified as requiring further study for the year 2030. The analysis was restricted to the eight watersheds identified as being deficient using projections out to the year 2030, and only examined reducing water availability in those eight identified watersheds in the lower portion of the Basin. It would be reasonable to expect that by reducing Q<sub>7</sub>10 and the 25-yr baseflow by 25%, 50%, and 75% in the other 137 watersheds that additional deficits in the Basin would have to be addressed, and that FE Walter Mod could be a possible solution to meet those deficits.

Table 2.24

Delaware River Water Supply Conditions in 2030 with Watersheds Identified for Further Study Incorporated

Map ID (1)	Water Use Type (2)	Natural Q <sub>7-10</sub> for Year 2030 (mgd) (3)	Adjusted Q <sub>7-10</sub> Based Upon Watershed Demands for Year 2030 (mgd) (4)	Projected Cumul. Consumptive Use Above Withdrawal Point Year 2030 (mgd) (5)	Projected Withdrawal at Point Year 2030 (mgd) (6)	Adjacent Watershed Needs for Year 2030 (mgd) (7)	Cumulative Adjacent Watershed Needs for Year 2030 (mgd) (8)	Withdrawal as Percentage of Natural Q <sub>7-10</sub> (mgd) (9)	Additional Flow Needed to Lower Utilization Below 75% for Power Sector (mgd) (10)	Additional Flow Needed to Lower Utilization Below 75% for Other Sectors (mgd) (11)
40	GOLF	929.45	929.45	0.00	0.44	0.00	0.00	0.05	0.00	0.00
<b>BRODHEAD CREEK</b>										
3	PWR	1058.36	1058.36	0.39	614.71	0.00	0.00	58.10	0.00	0.00
80	MANUF	1061.85	1061.85	2.97	1.45	0.00	0.00	0.14	0.00	0.00
5	PWR	1104.96	1104.96	3.41	0.00	0.00	0.00	0.00	0.00	0.00
6	PWR	1104.96	1104.96	3.41	15.00	0.00	0.00	1.36	0.00	0.00
23	PWR	1104.96	1104.96	7.39	2.04	0.00	0.00	0.19	0.00	0.00
83	RES. INTAKE	1104.96	1104.96	8.24	0.00	0.00	0.00	0.00	0.00	0.00
41	PWS	1126.12	1126.12	8.24	7.84	0.00	0.00	0.70	0.00	0.00
75	MANUF	1552.17	1552.17	13.39	0.00	0.00	0.00	0.00	0.00	0.00
72	PWR	1552.17	1552.17	13.39	3.11	0.00	0.00	0.20	0.00	0.00
90	AG	1552.17	1552.17	13.96	0.00	0.00	0.00	0.00	0.00	0.00
91	AG	1552.17	1552.17	13.96	0.00	0.00	0.00	0.00	0.00	0.00
34	PWS	1600.56	1419.86	13.96	18.80	0.00	0.00	1.34	0.00	0.00
<b>DEMAND: WATERSHED DB-108 = 1.7 mgd</b> <b>DEMAND: SCHUYLKILL (D/S of Perkiomen) = 100 mgd</b> <b>DEMAND TOTAL = 101.7 mgd</b> <b>UTILIZING PT PLEASANT PUMPING INTAKE NODE #46</b>										

Table 2.24

Delaware River Water Supply Conditions in 2030 with Watersheds Identified for Further Study Incorporated (Continued)

(1) Map ID	(2) Water Use Type	(3) Natural Q <sub>7-10</sub> for Year 2030 (mgd)	(4) Adjusted Q <sub>7-10</sub> Based Upon Watershed Demands for Year 2030 (mgd)	(5) Projected Cumul. Consumptive Use Above Withdrawal Point Year 2030 (mgd)	(6) Projected Withdrawal at Point Year 2030 (mgd)	(7) Adjacent Watershed Needs for Year 2030 (mgd)	(8) Cumulative Adjacent Watershed Needs for Year 2030 (mgd)	(9) Withdrawal as Percentage of Natural Q <sub>7-10</sub> (mgd)	(10) Additional Flow Needed to Lower Utilization Below 75% for Power Sector (mgd)	(11) Additional Flow Needed to Lower Utilization Below 75% for Other Sectors (mgd)
46	PWS	1600.56	1498.86	15.84	24.80	101.70	101.70	1.67	0.00	0.00
<b>DELAWARE &amp; RARITAN CANAL - NODE 82 WITHDRAWAL</b>										
82	PWS	1601.23	1499.53	18.32	100.96	0.00	101.70	6.82	0.00	0.00
42	PWS	1622.61	1520.91	119.28	0.01	0.00	101.70	0.00	0.00	0.00
88	PWS	1644.14	1542.44	119.29	29.69	0.00	101.70	2.09	0.00	0.00
36	PWS	1644.14	1542.44	119.29	3.18	0.00	101.70	0.22	0.00	0.00
<b>USGS GAGE AT TRENTON</b>										
35	PWS	1644.19	1542.49	122.25	3.00	0.00	101.70	0.21	0.00	0.00
<b>ASSUNIPINK CREEK</b>										
<b>1</b>	<b>PWR</b>	<b>1673.60</b>	<b>1571.90</b>	<b>122.55</b>	<b>1364.69</b>	<b>0.00</b>	<b>101.70</b>	<b>94.16</b>	<b>379.34</b>	<b>0.00</b>
22	PWR	1714.56	1612.86	130.34	4.30	0.00	101.70	0.29	0.00	0.00
44	COMM	1714.56	1612.86	131.88	43.50	0.00	101.70	2.94	0.00	0.00
14	PWR	1714.76	1613.06	136.23	95.87	0.00	101.70	6.49	0.00	0.00
38	PWS	1714.76	1613.06	137.55	7.93	0.00	101.70	0.54	0.00	0.00
37	PWS	1730.58	1628.88	138.34	5.95	0.00	101.70	0.40	0.00	0.00
87	PWS	1730.59	1628.89	138.93	0.00	0.00	101.70	0.00	0.00	0.00
33	MANUF	1731.40	1629.70	138.93	0.40	0.00	101.70	0.03	0.00	0.00
86	PWS	1743.48	1641.78	138.97	2.18	0.00	101.70	0.15	0.00	0.00

Table 2.24  
Delaware River Water Supply Conditions in 2030 with Watersheds Identified for Further Study Incorporated (Continued)

ASSUMPINK CREEK CONTINUED										
73	PWR	1744.42	1642.72	139.19	0.00	0.00	101.70	0.00	0.00	0.00
NESHAMINY CREEK										
39	PWS	1891.44	1789.74	139.19	140.83	0.00	101.70	8.53	0.00	0.00
DEMAND: WATERSHED DB-90 (GW) = 13.9 mgd										
DEMAND: WATERSHED DB-92 (GW) = 8.2 mgd										
DEMAND: WATERSHED DB-111 (GW) = 10.1 mgd										
DEMAND: WATERSHED DB-137 (GW) = 77.1 mgd										
DEMAND: WATERSHED DB-117 (SW) = 0.4 mgd										
DEMAND: WATERSHED DB-118 (SW) = 1.3 mgd										
(1)	(2)	(3)	(4)	(5)	(6)	(7)	(8)	(9)	(10)	(11)
DEMAND TOTAL = 111 mgd										
UTILIZING AMERICAN WATER CO'S TRI-COUNTY WATER										
SUPPLY PIPELINE INTAKE NODE #89)										
89	PWS	1893.41	1680.71	153.27	18.07	111.00	212.70	1.18	0.00	0.00
45	MANUF	1911.60	1698.90	155.08	0.77	0.00	212.70	0.05	0.00	0.00
84	MANUF	1921.94	1709.24	155.08	0.16	0.00	212.70	0.01	0.00	0.00
30	MANUF	1921.94	1709.24	155.10	10.28	0.00	212.70	0.66	0.00	0.00
74	MINING	1931.18	1718.48	156.13	0.00	0.00	212.70	0.00	0.00	0.00
8	PWR	1933.25	1720.55	156.13	0.00	0.00	212.70	0.00	0.00	0.00
18	PWR	1951.40	1738.70	156.13	30.89	0.00	212.70	1.95	0.00	0.00
77	MANUF	1951.41	1738.71	156.29	0.00	0.00	212.70	0.00	0.00	0.00
78	MANUF	1951.42	1738.72	156.29	0.00	0.00	212.70	0.00	0.00	0.00
79	MANUF	1951.42	1738.72	156.29	0.00	0.00	212.70	0.00	0.00	0.00
SCHUYLKILL RIVER										
TOTALS				156.29	2550.83	212.70	212.70		379.34	0.00

Notes:

Column (4) = Column (3) – Column (8)

Column (8) taken from Table 5 for Lower Schuylkill and Table 7 for PA & NJ Watersheds Identified for Further Study

**Table 2.25: 50% Reductions in Available Water for Delaware River with Watersheds Identified for Further Study Incorporated**

Map ID (1)	Water Use Type (2)	Natural Q <sub>7-10</sub> for Year 2030 (mgd) (3)	Adjusted Q <sub>7-10</sub> Based Upon Watershed Demands for Year 2030 (mgd) (4)	Projected Cumul. Consumptive Use Above Withdrawal Point Year 2030 (mgd) (5)	Projected Withdrawal at Point Year 2030 (mgd) (6)	Adjacent Watershed Needs Under 50% Reduction of Avail. Water (mgd) (7)	Cumulative Adjacent Watershed Needs (mgd) (8)	Withdrawal as Percentage of Natural Q <sub>7-10</sub> (mgd) (9)	Additional Flow Needed to Lower Utilization Below 75% for Power Sector (mgd) (10)	Additional Flow Needed to Lower Utilization Below 75% for Other Sectors (mgd) (11)
40	GOLF	489.18	489.18	0.00	0.44	0.00	0.00	0.09	0.00	0.00
<b>BRODHEAD CREEK</b>										
<b>3</b>	<b>PWR</b>	<b>557.03</b>	<b>557.03</b>	<b>0.39</b>	<b>614.71</b>	<b>0.00</b>	<b>0.00</b>	<b>110.43</b>	<b>267.07</b>	<b>0.00</b>
80	MANUF	558.87	558.87	2.97	1.45	0.00	0.00	0.26	0.00	0.00
5	PWR	581.56	581.56	3.41	0.00	0.00	0.00	0.00	0.00	0.00
6	PWR	581.56	581.56	3.41	15.00	0.00	0.00	2.59	0.00	0.00
23	PWR	581.56	581.56	7.39	2.04	0.00	0.00	0.36	0.00	0.00
83	RES. INTAKE	581.56	581.56	8.24	0.00	0.00	0.00	0.00	0.00	0.00
41	PWS	592.70	592.70	8.24	7.84	0.00	0.00	1.34	0.00	0.00
75	MANUF	816.93	816.93	13.39	0.00	0.00	0.00	0.00	0.00	0.00
72	PWR	816.93	816.93	13.39	3.11	0.00	0.00	0.39	0.00	0.00
90	AG	816.93	816.93	13.96	0.00	0.00	0.00	0.00	0.00	0.00
91	AG	816.93	816.93	13.96	0.00	0.00	0.00	0.00	0.00	0.00
34	PWS	842.40	661.70	13.96	18.80	0.00	0.00	2.90	0.00	0.00
<b>DEMAND: WATERSHED DB-108 = 2.4 mgd</b> <b>DEMAND: SCHUYLKILL (D/S of Perkiomen) = 123.4 mgd</b> <b>DEMAND TOTAL = 126 mgd</b> <b>UTILIZING PT PLEASANT PUMPING INTAKE NODE #46</b>										
46	PWS	842.40	716.40	15.84	24.80	126.00	126.00	3.54	0.00	0.00

Map ID	Water Use Type	Natural Q <sub>7-10</sub> for Year 2030 (mgd)	Adjusted Q <sub>7-10</sub> Based Upon Watershed Demands for Year 2030 (mgd)	Projected Cumul. Consumptive Use Above Withdrawal Point Year 2030 (mgd)	Projected Withdrawal at Point Year 2030 (mgd)	Adjacent Watershed Needs Under 50% Reduction of Avail. Water (mgd)	Cumulative Adjacent Watershed Needs (mgd)	Withdrawal as Percentage of Natural Q <sub>7-10</sub> (mgd)	Additional Flow Needed to Lower Utilization Below 75% for Power Sector (mgd)	Additional Flow Needed to Lower Utilization Below 75% for Other Sectors (mgd)
<b>DELAWARE &amp; RARITAN CANAL - NODE 82 WITHDRAWAL</b>										
82	PWS	842.75	716.75	18.32	100.96	0.00	126.00	14.46	0.00	0.00
42	PWS	854.01	728.01	119.28	0.01	0.00	126.00	0.00	0.00	0.00
<b>(1)</b>	<b>(2)</b>	<b>(3)</b>	<b>(4)</b>	<b>(5)</b>	<b>(6)</b>	<b>(7)</b>	<b>(8)</b>	<b>(9)</b>	<b>(10)</b>	<b>(11)</b>
88	PWS	865.33	739.33	119.29	29.69	0.00	126.00	4.79	0.00	0.00
36	PWS	865.33	739.33	119.29	3.18	0.00	126.00	0.51	0.00	0.00
<b>USGS GAGE AT TRENTON</b>										
35	PWS	865.36	739.36	122.25	3.00	0.00	126.00	0.49	0.00	0.00
<b>ASSUNIPINK CREEK</b>										
<b>1</b>	<b>PWR</b>	<b>880.84</b>	<b>754.84</b>	<b>122.55</b>	<b>1364.69</b>	<b>0.00</b>	<b>126.00</b>	<b>215.83</b>	<b>1196.40</b>	<b>0.00</b>
22	PWR	902.40	776.40	130.34	4.30	0.00	126.00	0.67	0.00	0.00
44	COMM	902.40	776.40	131.88	43.50	0.00	126.00	6.75	0.00	0.00
14	PWR	902.51	776.51	136.23	95.87	0.00	126.00	14.97	0.00	0.00
38	PWS	902.51	776.51	137.55	7.93	0.00	126.00	1.24	0.00	0.00
37	PWS	910.83	784.83	138.34	5.95	0.00	126.00	0.92	0.00	0.00
87	PWS	910.84	784.84	138.93	0.00	0.00	126.00	0.00	0.00	0.00
33	MANUF	911.26	785.26	138.93	0.40	0.00	126.00	0.06	0.00	0.00
86	PWS	917.62	791.62	138.97	2.18	0.00	126.00	0.33	0.00	0.00
73	PWR	918.11	792.11	139.19	0.00	0.00	126.00	0.00	0.00	0.00
<b>NESHAMINY CREEK</b>										
39	PWS	995.49	869.49	139.19	140.83	0.00	126.00	19.28	0.00	0.00
<b>DEMAND: WATERSHED DB-90 (GW) = 23.9 mgd</b>										
<b>DEMAND: WATERSHED DB-92 (GW) = 17.3 mgd</b>										

Map ID	Water Use Type	Natural Q <sub>7-10</sub> for Year 2030 (mgd)	Adjusted Q <sub>7-10</sub> Based Upon Watershed Demands for Year 2030 (mgd)	Projected Cumul. Consumptive Use Above Withdrawal Point Year 2030 (mgd)	Projected Withdrawal at Point Year 2030 (mgd)	Adjacent Watershed Needs Under 50% Reduction of Avail. Water (mgd)	Cumulative Adjacent Watershed Needs (mgd)	Withdrawal as Percentage of Natural Q <sub>7-10</sub> (mgd)	Additional Flow Needed to Lower Utilization Below 75% for Power Sector (mgd)	Additional Flow Needed to Lower Utilization Below 75% for Other Sectors (mgd)
<b>DEMAND: WATERSHED DB-111 (GW) = 19.0 mgd</b>										
<b>DEMAND: WATERSHED DB-137 (GW) = 100.7 mgd</b>										
<b>DEMAND: WATERSHED DB-117 (SW) = 2.1 mgd</b>										
<b>DEMAND: WATERSHED DB-118 (SW) = 2.8 mgd</b>										
(1)	(2)	(3)	(4)	(5)	(6)	(7)	(8)	(9)	(10)	(11)
<b>DEMAND TOTAL = 166 mgd</b>										
<b>UTILIZING AMERICAN WATER CO'S TRI-COUNTY WATER SUPPLY PIPELINE INTAKE NODE #89)</b>										
89	PWS	996.53	704.53	153.27	18.07	166.00	292.00	3.28	0.00	0.00
45	MANUF	1006.10	714.10	155.08	0.77	0.00	292.00	0.14	0.00	0.00
84	MANUF	1011.55	719.55	155.08	0.16	0.00	292.00	0.03	0.00	0.00
30	MANUF	1011.55	719.55	155.10	10.28	0.00	292.00	1.82	0.00	0.00
74	MINING	1016.41	724.41	156.13	0.00	0.00	292.00	0.00	0.00	0.00
8	PWR	1017.50	725.50	156.13	0.00	0.00	292.00	0.00	0.00	0.00
18	PWR	1027.05	735.05	156.13	30.89	0.00	292.00	5.34	0.00	0.00
77	MANUF	1027.06	735.06	156.29	0.00	0.00	292.00	0.00	0.00	0.00
78	MANUF	1027.07	735.07	156.29	0.00	0.00	292.00	0.00	0.00	0.00
79	MANUF	1027.07	735.07	156.29	0.00	0.00	292.00	0.00	0.00	0.00
<b>SCHUYLKILL RIVER</b>										
<b>TOTALS</b>				<b>156.29</b>	<b>2550.83</b>	<b>292.00</b>	<b>292.00</b>		<b>1463.47</b>	<b>0.00</b>

Notes:

Column (4) = Column (3) – Column (8)

Column (8) taken from Table 11 for Lower Schuylkill and Table 7 for PA & NJ Watersheds Identified for Further Study



#### **2.4.1.8 Reservoir Storage in the Schuylkill River Basin**

A review of reservoir projects proposed in H.D. 522 was done in order to identify potential water source projects that could alleviate the water deficits calculated for the drought sensitivity analysis (Table 11) for the Schuylkill River Basin. H.D. 522 screened 193 potential major dam sites that would satisfy widespread needs for water supply, flood control, recreation, and hydropower. Nineteen major dam projects were selected based upon several screening levels that were done that took into account factors such as worthiness of the project to satisfy multiple needs (flood control, water supply, and recreation) balanced against the cost estimate of the project.

H.D. 522 also screened 386 small dam sites to address uneven stream flows at a local problem reaches in the intermediate upstream areas. These small dam sites were restricted to drainage areas of no more than 20 square miles. Successive screenings of these sites brought the total down to 39 that were recommended in the final plan. These projects were earmarked for local flood control primarily and for recreation, and water supply to the extent warranted by local needs and interest.

The 1984 Delaware River Basin Study conducted by the Corps re-evaluated previously identified sites. Sites from H.D. 522, Madigan-Praeger Report, TAMS Reports, the Basin Electric Utility group (DRBEUG), the DRBC, and the Level "B" Study were compiled. Criteria was established that eliminated all the sites except for Aquashicola in the Lehigh River Basin and Cherry Creek on the Delaware River. The criteria follows:

1. Projects had to be located above Trenton NJ.
2. Projects had to have a minimum 20,000 ac-ft of storage for flood control and a minimum uncontrolled drainage area of 50 sq. miles.
3. Projects could not be located on Federal or State designated scenic rivers, protected areas, nor on the main-stem
4. Projects which were part of the Level "B" Plan and are designated for water supply were considered unavailable to provide protection.
5. Projects could not require extensive relocation of major roads railways or structures.
6. Projects in environmentally and socially sensitive areas would reinforce other negative findings.
7. Projects could not be economically feasible as a single purpose flood control project if they were infeasible as a flood control component of a multipurpose project.

Applying the criteria from the 1984 Report eliminated all sites below Trenton, NJ which includes the entire Schuylkill River Basin. The 1984 Report also evaluated all the projects based primarily on flood control and did not consider in its conclusions projects for water supply. It is for this reason that H.D. 522 was utilized as the basis for identifying potential water supply projects.

Three reservoir projects were identified from H.D 522 for the Schuylkill River Basin as potential projects to consider for water supply flow augmentation in this analysis. They were Maiden Creek, French Creek, and Evansburg. These projects were included as part of the 19 major dam

projects recommended in H.D. 522 but never constructed for various reasons. Locations of these reservoirs as examined in H.D. 522 are shown in Figure 2.38. In addition to these three reservoirs, modifying the existing Blue Marsh Reservoir was considered for water supply flow augmentation for the drought sensitivity analysis.

These three reservoirs along with modification of Blue Marsh Reservoir should be considered only as a few of many possible solutions to the water deficiency issues identified on the Schuylkill. Many structural and non-structural solutions exist within the Schuylkill Basin that were beyond the scope of this analysis and therefore not examined. The review of H.D. 522 and the subsequent inclusion of Maiden Creek, French Creek, Evansburg Reservoirs along with modification of Blue Marsh into the river analysis by no means should be interpreted as the only solutions to the water supply issues identified in this report. The intent of this analysis was to identify some potential water supply issues and to examine some possible solutions to them. A further detailed investigation should be done to identify the specific magnitude of the water supply issues and applicability of these reservoir projects along with others. Other structural and non-structural projects should be part of the detailed investigation as well.

As previously stated in the report, the deficiencies attributable to the power sector in year 2030 were not incorporated into the solution provided by these three reservoirs. The three reservoirs embedded into the analysis were only used to alleviate the deficits attributable to all other sectors besides power. Since the 2030 analysis showed (Table 2.16) no deficits attributable to sectors other than power, these reservoirs were incorporated into the drought sensitivity analysis for the Schuylkill River. The following sections describing Maiden Creek, French Creek, and Evansburg were taken from H.D. 522.

**2.4.1.8.1 Maiden Creek.** The Maiden Creek Project was originally proposed for multiple-purpose development to provide supplies of water, flood control and recreation. The Maiden Creek dam site is located on Maiden Creek about 1/3 mile upstream from the mouth of Moselem Creek and about 12 miles north of Reading, PA. The drainage area above this site is 161 square miles. The original dam design as stated in H.D. 522 was 2,600 feet long and rising 110 feet above the bed of Maiden Creek. It would be of earth and rock fill construction. It was also reported that the spillway would be 71.0 feet wide and would be cut through a rock ridge about 400 feet east of the dam. Storage allocations for the Maiden Creek Project as indicated in H.D. 522, were 2,000 acre-feet of inactive long-term storage to elevation 323 ft.; 74,000 acre-feet of active long-term storage for supplies of water and recreation to elevation 381 ft.; and 38,000 acre-feet of short-term storage for flood control to elevation 394 ft. It was proposed that the reservoir would extend about 10 miles up Maiden Creek and relocation of a railroad line, numerous roads, and the communities of Lenhartsville, Virginville and a part of Moselem would be required according to H.D. 522. An updated site investigation was not done as part of this analysis. It was also reported in H.D. 522 that a total of 8,450 acres of land would have to be acquired for the complete development. It was also reported that in addition to the 2,850 acres required for the construction of the project, 2,255 acres would be required for directly related recreation and 3,345 acres for indirectly related recreation. H.D. 522 documented that the use of

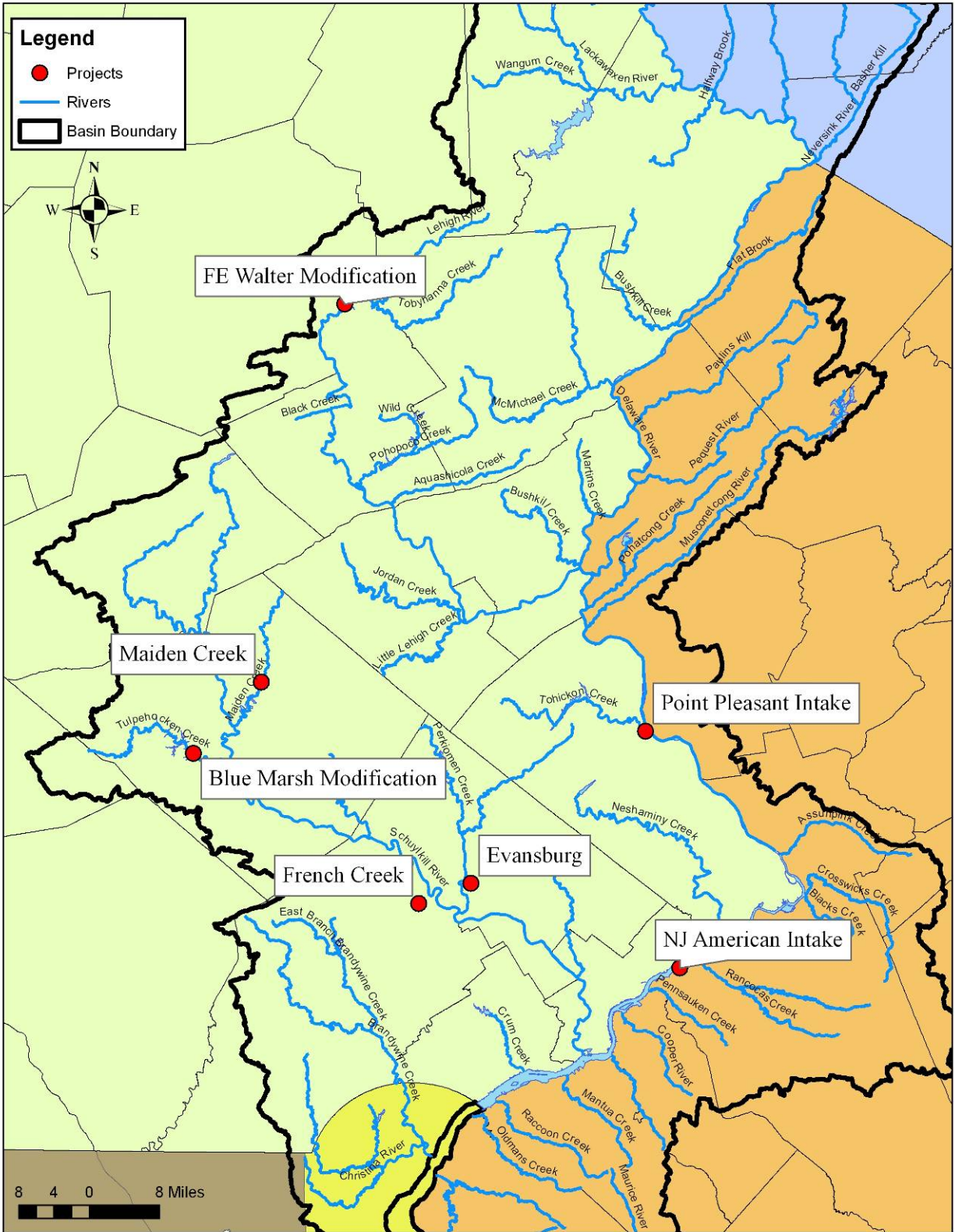

Figure 2.38: Location of Projects

the 74,000 acre-feet of active long-term storage at Maiden Creek Project would provide a net yield of 134 cfs (87 MGD). The report also foresaw that flow augmentation from Maiden Creek would contribute to the satisfaction of the needs of the Pottstown-Reading area as well as to the Philadelphia area.

**2.4.1.8.2 French Creek.** The French Creek Project as described in H.D. 522 was to be fully developed in two stages and would be a multiple-purpose project to provide supplies of water and recreation. The project site is located about 9.5 miles above the mouth of French Creek and 8 miles west of Phoenixville, Pennsylvania. The drainage area upstream from the dam site is 47 square miles. It was reported that the suggested storage allocations for ultimate development was 1,300 acre-feet of inactive long-term storage to elevation 240 and 25,700 acre-feet of active long-term storage for supplies of water and recreation to elevation 289. H.D. 522 also stated that the reservoir at elevation 289 would extend 8 miles upstream from the dam and provide a reservoir area of 1,250 acres. Total lands, including the eventual reservoir area desirable for the initial stage of development would include 4,270 acres. When fully developed French Creek the 25,700 acre-feet of active long-term storage in the French Creek Project would provide a net yield of 33 cfs (21 MGD).

**2.4.1.8.3 Evansburg.** The Evansburg Project was projected to be developed in two stages and would be a multiple-purpose project to provide supplies of water and recreation. The project site is located on Skippack Creek about a mile above its confluence with Perkiomen Creek and about two miles southeast of Collegetown, Pennsylvania. The drainage area above the dam site is 54 square miles. H.D. 522 reported that the suggested storage allocations for ultimate development were 1,500 acre-feet of inactive long-term storage to elevation 125 and 23,500 acre-feet of active long-term storage for supplies of water and recreation to elevation 166. The reservoir at elevation 166 would extend about eight miles upstream from the dam and provide a reservoir area of 1,120 acres. It was also reported that the total lands, including the eventual reservoir area would be 4,654 acres. When fully developed, use of the 23,500 acre-feet of active long-term storage in the Evansburg Project would provide a net yield of 36 cfs (23 MGD). The old study also foresaw that flow augmentation from Evansburg would contribute to the satisfaction of the water needs after the year 2010.

The 120 day average yield was used for each potential reservoir: The yield value is defined as the sustained constant draft which completely utilizes all of the active long-term storage in a drought similar to the 1930s. Values were taken directly from H.D. 522 (see previous section) Table M-31a except for Blue Marsh Mod which was not considered at the time and with one minor adjustment to the other reservoirs. The adjustment was a 5% reduction in the yield values in order to account for climate variability as previously mentioned in this report. All yield values used are shown below:

Table 2.26  
Reservoir Yields

<b>Project</b>	<b>Basin</b>	<b>Mean Monthly Yield in 2003 (mgd)</b>	<b>Projected Mean Monthly Yield in 2030 (mgd)</b>
Maiden Creek	Schuylkill	114	108
Blue Marsh Mod	Schuylkill	71	68
French Creek	Schuylkill	28	26
Evansburg	Schuylkill	30	29
FE Walter Mod	Lehigh	173	164

The 120-day average yield for a modified Blue Marsh project was determined by calculating the necessary quantity of water needed to alleviate deficits from all sectors other than from the power sector for the drought sensitivity analysis that reduced available flows by 50%. It was back-calculated using the storage-elevation curve for Blue Marsh that in order to provide the additional 173 MGD, the pool elevation would have to be raised by 20 feet.

A detailed site investigation as to the practicality of modifying Blue Marsh was not done as part of this analysis. As with the other reservoirs incorporated into this analysis, it is recommended that further investigation be done.

Table 2.27 summarizes the drought sensitivity analysis on the Schuylkill River when available water is reduced by 50% along with the additional storage Maiden Creek, French Creek, and Evansburg could provide to the Basin. Comparing Table 2.27 with Table 2.22 shows that the 139 mgd deficit due to all sectors other than power has been eliminated and the 957 mgd deficit due to the power sector withdrawals has been reduced to 497 mgd. Only one withdrawal point remains in deficit on the Schuylkill River; that is a reduction of seven withdrawal points from the ones identified in Table 2.22. Additional Schuylkill River tables summarizing other percentages used in the drought sensitivity analysis along with the effects of augmenting flow from a modified Blue Marsh Reservoir are shown in Technical Appendix A.

Table 2.27

50% Reductions in Available Water for Schuylkill River with Potential Reservoir Projects Incorporated

Map ID (1)	Water Use Type (2)	50% Reduction in Natural Q <sub>7-10</sub> (mgd) (3)	Adjusted Q <sub>7-10</sub> (mgd) (4)	Projected Cumul. Consumptive Use Above Withdrawal Point for Year 2030 (mgd) (5)	Projected Withdrawal at Point for Year 2030 (mgd) (6)	Projected Yield from Potential Projects (mgd) (7)	Withdrawal as Percentage of Adjusted Q <sub>7-10</sub> (mgd) (8)	Additional Flow Needed to Lower Utilization Below 75% for Power Sector (mgd) (9)	Additional Flow Needed to Lower Utilization Below 75% for Other Sectors (mgd) (10)
54	AG	30.47	30.47	0.00	0.00	0.00	0.00	0.00	0.00
68	MANUF	30.51	30.51	0.00	0.00	0.00	0.00	0.00	0.00
<b>PROJECT: MAIDEN CREEK (108 mgd Added Flow)</b>									
63	MANUF	46.59	154.59	0.00	0.34	108.00	0.22	0.00	0.00
4	PWR	48.37	156.37	0.03	33.82	108.00	21.63	0.00	0.00
<b>TULPEHOCKEN CREEK</b>									
<b>USGS GAGE AT READING</b>									
67	PWS	76.30	184.30	2.94	4.78	108.00	2.64	0.00	0.00
<b>MANATAWNY CREEK</b>									
<b>USGS GAGE AT POTTSTOWN</b>									
55	MANUF	83.64	191.64	3.42	0.12	108.00	0.06	0.00	0.00
11	PWR	84.99	192.99	3.43	84.41	108.00	44.53	0.00	0.00
64	PWS	86.48	194.48	70.01	2.71	108.00	2.18	0.00	0.00
58	PWS	87.99	195.99	70.28	3.67	108.00	2.92	0.00	0.00
7	<b>PWR</b>	<b>88.01</b>	<b>196.01</b>	<b>70.65</b>	<b>384.20</b>	<b>108.00</b>	<b>306.47</b>	<b>497.46</b>	<b>0.00</b>
<b>PROJECT: FRENCH CREEK (26 mgd Added Flow)</b>									
62	PWS	94.07	228.07	72.76	27.28	134.00	17.56	0.00	0.00
<b>PERKIOMEN CREEK</b>									
<b>PROJECT: EVANSBURG (29 mgd Added Flow)</b>									

Map ID	Water Use Type	50% Reduction in Natural Q <sub>7-10</sub> (mgd)	Adjusted Q <sub>7-10</sub> (mgd)	Projected Cumul. Consumptive Use Above Withdrawal Point for Year 2030 (mgd)	Projected Withdrawal at Point for Year 2030 (mgd)	Projected Yield from Potential Projects (mgd)	Withdrawal as Percentage of Adjusted Q <sub>7-10</sub> (mgd)	Additional Flow Needed to Lower Utilization Below 75% for Power Sector (mgd)	Additional Flow Needed to Lower Utilization Below 75% for Other Sectors (mgd)
(1)	(2)	(3)	(4)	(5)	(6)	(7)	(8)	(9)	(10)
60	PWS	128.70	291.70	75.48	11.87	163.00	5.49	0.00	0.00
<b>USGS GAGE AT NORRISTOWN</b>									
61	MANUF	129.42	292.42	76.67	0.27	163.00	0.12	0.00	0.00
56	MANUF	136.10	299.10	76.70	6.31	163.00	2.84	0.00	0.00
<b>WISSAHICKON CREEK</b>									
65	PWS	137.29	300.29	76.77	76.09	163.00	34.04	0.00	0.00
66	PWS	137.48	300.48	152.86	49.67	163.00	33.65	0.00	0.00
<b>USGS GAGE AT PHILADELPHIA</b>									
20	PWR	137.97	300.97	202.53	71.28	163.00	72.42	0.00	0.00
69	PWR	137.97	300.97	202.64	11.18	163.00	11.37	0.00	0.00
10	PWR	137.97	300.97	203.36	91.64	163.00	93.88	0.00	0.00
59	MANUF	138.73	301.73	203.66	2.08	163.00	2.12	0.00	0.00
57	MANUF	138.79	301.79	204.25	8.25	163.00	8.46	0.00	0.00
<b>DELAWARE RIVER</b>									
<b>TOTALS</b>				<b>204.25</b>	<b>869.98</b>			<b>497.46</b>	<b>0.00</b>

Notes:

Column (4) = Column (3) + Column (7)

## 2.4.2 Approaches to Curtail Demand

### 2.4.2.1 Improved Water Accountability with Reduced Infrastructure

**Losses:** The DRBC continues to promote best practice in water conservation and continues to have to implement regulations that reflect current best practice. One such area is in advancing the issue of *Water Accountability* for public water suppliers. The water accountability issue focuses on how water is managed within the distribution system by the water supplier and has a specific focus on minimizing water loss from the distributions system. This provides a different focus from many traditional end-user oriented water conservation programs. It is estimated that 150 million gallons of treated and pressurized water is physically lost from public water supply distribution systems in the Delaware River Basin each day and current methods to account for, track and reduce these losses are inadequate.

Traditionally, this issue has been addressed using the concept of “unaccounted for water”; however, this approach has several flaws, such as a lack of standardized terminology and lack of a rigid water audit structure. A new approach has evolved from within the water industry and has been promoted by the American Water Works Association (AWWA). The Delaware River Basin Commission believes that by requiring water suppliers to implement the new AWWA water audit methodology, the following benefits are likely to be realized:

- utility managers (especially those operating smaller systems) will better understand their systems.
- the use of a more rational water audit structure will help identify water losses and target efforts to improve water supply system efficiency.
- more meaningful performance indicators will help identify systems with the greatest losses.

In addition to the large volume of potential savings that can be made by reducing and minimizing water losses in the distribution system, the fact that the lost water serves no beneficial use provides added incentive to control losses. In contrast to many traditional water conservation programs, savings realized from water loss control will not impact end-users in any way.

#### **The Water Accountability Audit Approach:**

The traditional approach of tracking “unaccounted for water” relied on a very simplistic modeling of the distribution system and utilized performance indicators that were not technically robust. The AWWA water audit approach has well-defined terminology and requires system operators to examine the complete spectrum of how water may be lost in the distribution system. The audit approach covers both physical losses of water and also apparent losses which take the form of paper losses and may impact the revenue collected by the water supplier. Examples of apparent losses include meter error, billing error and theft. A schematic representation of the AWWA water audit approach is shown in Figure 2.39.



System Input Volume (corrected for known errors)	Authorized Consumption	Billed Authorized Consumption	Billed Metered Consumption (including water exported)	Revenue Water	
			Billed Unmetered Consumption		
	Water Losses	Unbilled Authorized Consumption		Unbilled Metered Consumption	Non-Revenue Water (NRW)
				Unbilled Unmetered Consumption	
		Apparent Losses		Unauthorized Consumption	
				Customer Metering Inaccuracies	
				Data Handling Errors	
		Real Losses		Leakage on Transmission and Distribution Mains	
				Leakage and Overflows at Utility's Storage Tanks	
				Leakage on Service Connections up to point of Customer metering	

Figure 2.39 AWWA Water Accountability Water Audit Structure

Estimating the potential savings in water demand due to the identification and remediation of water losses is a complex challenge. Traditional measures of water loss indicate that the majority of systems physically lose between 5% and 35% of the water that enters the distribution system; however the accuracy of these estimates is questionable due to the problems identified above with the method of estimation. Older systems are likely to experience the highest losses due to the age of the infrastructure.

Rural systems may also experience high losses due to the greater likelihood of a significant leak going undetected. In general, small systems (<35,000 customers) are also likely to have large losses as many of these systems will not have the resources or expertise on staff to conduct regular water audits and carry out leak detection and repair activities.

In the Delaware River Basin, the largest water purveyor is the Philadelphia Water Department (PWD), with an average daily water demand of approximately 235 million gallons per day (mgd). The PWD system has a history of significant water losses due to aging infrastructure (the system is among the oldest in the U.S.) and a declining population, which means a declining customer base from which to obtain revenue and fund repairs. Recognizing these challenges, the PWD system has been studied extensively and the AWWA water audit approach has been implemented to identify the extent and nature of the water losses throughout the system. Based on 2006 data, estimated physical losses in the distribution system were approximately 60mgd (or 25% of distribution system input). According to the AWWA water audit approach, the unavoidable real losses for the system are approximately 6mgd (this represents less than

3% of system input). This is the level that is technically achievable by applying the best available technology and an aggressive level of leakage control.

An approximation of the reduction that may be possible by addressing water loss issues in the Delaware River Basin can be calculated using data from the PWD example. Although the exact extent of water loss from infrastructure failings in the Basin is unknown a likely range can be estimated. Table 2.28 below shows a range of potential existing levels of water loss and a range of potential target levels of loss, along with the estimated savings achievable by moving from an existing loss level to a target loss level (the intersection of the rows and columns). As an example, if, on average, the existing level of water loss for PWS systems is estimated at 15% and a target of 5% is achievable, then the potential savings are 95.3 million gallons per day. The likely range of savings is highlighted and ranges from 76.3mgd to 143mgd, as a basin-wide total.

Table 2.28  
Range of potential savings from addressing water loss issues within PWS

Current level of losses (as % of system input)	Target level of losses (as % of system input)			
	3%	5%	7%	10%
10%	66.7	47.7	28.6	0.0
15%	114.4	95.3	76.3	47.7
20%	162.0	143.0	123.9	95.3
25%	209.7	190.6	171.6	143.0

Values of potential savings expressed as million gallons per day (mgd).

Additional water supply alternatives, ranging from conjunctive use practices, aquifer-storage-recovery (ASR), pumping from other water-bearing aquifers, water reclamation and reuse (wastewater, desalination) and mine discharges were evaluated in a literature review and were found not to be viable on a regional scale. However, they may be practical at a local level and should be considered in future water supply studies. However, they should not be considered “new found” water but as water being used at a different location in the water cycle.

**2.4.2.2 Additional Conservation:** Conservation assumptions were embedded into the water supply analysis presented in this report. The assumptions were based upon projecting current conservation practices into the future for each given sector. Assuming additional water conservation scenarios above and beyond current practices would curtail demand and lower the projected water deficits. Potential impacts of implementing these scenarios should be investigated further as part of a comprehensive drought analysis study for the Basin.

**2.4.2.3 Change Water Allocations/New Regulations:** Demand could also be curtailed by lowering water allocations given to purveyors along with implementing stricter water supply regulations that protect water sources in critical areas where demand exceeds supply. A comprehensive review of existing long-standing allocations given to purveyors along with current water supply regulations in critical areas within the Basin should be investigated as part of a comprehensive drought analysis study

**2.4.2.5 Improved Irrigation Techniques:** Drip irrigation is a conservation measure that allows for the slow, even application of low pressure water to soil and plants using plastic tubing placed directly at the plants root zone. A well-designed drip irrigation system loses practically no water to runoff, deep percolation, or evaporation and curtails demand. Drip irrigation reduces water contact with crop leaves, stems, and fruit. In areas of the Basin where water demand is high due to the irrigation sectors, the potential quantifiable benefits in curtailing demand by implementing an improved technique such as drip irrigation should be investigated in further detail for practicability and cost effectiveness.

## **2.5 CONCLUSIONS AND RECOMMENDATIONS**

The findings of the Long Term Sufficiency Study include the following:

Based on the screening processes used in this study to identify watersheds with the greatest likelihood of potential future issues, those with the greatest level of water use relative to water availability, eight watersheds were selected for further investigation (DB-90, DB-92, DB-108, DB-111, DB-117, DB-118, DB-127 and DB-137). Many of these watersheds are located within two previously identified special management areas; the Southeastern Pennsylvania Ground Water Protected Area (GWPA) and New Jersey's Water Supply Critical Area 2.

For those watersheds selected for further investigation, a more detailed study of water use should be performed in conjunction with the relevant state agency and local watershed partners. A more detailed analysis would include verification of water use, tracking water imports and exports across watershed boundaries and the effects of any mitigation efforts (reservoir releases, pass-by flow requirements) that were not modeled in this Basin-wide effort. A better understanding of agricultural water demand is also needed in order to plan and manage water resources to accommodate all demands.

An assessment of water availability was performed for surface water intakes on the Delaware, Schuylkill and Lehigh rivers. The analysis concluded that, based on 2003 water demand, water availability under low flow conditions was adequate in most locations. In the base year, only one location, a power generation facility on the Schuylkill River, was identified as having a potential supply deficit. Based on projected water use for the year 2030, additional water demands for power generation may add further stress to the Schuylkill River and could potentially create stress in other parts of

the Basin. A study of the potential growth in water demand for the thermoelectric sector is recommended due to the impact that a large power generating facility may have on the Basin's water resources.

An assessment of additional storage in the Schuylkill River Basin should also be evaluated further, particularly for drought conditions.

### 3.0 FLOOD RISK MANAGEMENT

The Delaware River Basin has a long history of flooding dating back to the late 1800's. The Basin like all watersheds has been impacted by flooding because the people live, work, travel, and recreate in floodplains, and because their land use activities have increased the runoff from watersheds and changed the hydraulics of the floodplain itself.

Flooding in the Delaware River Basin is a result of excessive runoff produced by precipitation from either extra-tropical or tropical storms with the most damaging events being caused by tropical storms or remnants of hurricanes. The most widespread riverine flood event in the Delaware River Basin occurred in 1955, over fifty years ago. The National Weather Service has estimated repetition of this record flood event would cause \$2.8 billion in damages in the Basin in today's dollars. And although flooding of this scope and magnitude are rare, damage and loss of life from more localized flooding occurs frequently. Most recently, the remnants of Tropical Storm Allison caused \$35 million in damages and resulted in seven deaths in Bucks and Montgomery Counties, PA in June of 2001. The events of 2004, 2005 and 2006 also had devastating effects on the Basin causing a total of close to \$745 million worth of damage in the states of New York, New Jersey and Pennsylvania.

Below are photos of Lambertville, NJ showing the extent of flooding during the 2006 event.



Figure 3.1 Lambertville-New Hope Bridge



Figure 3.2 Lambertville

Due to the sudden onslaught of storm events in the past three years this study took the opportunity to join forces with the Delaware River Basin's Interstate Flood Mitigation Task Force, FEMA, USGS, DRBC, HEC, DRBC's Flood Advisory Committee and other agencies and organizations in order to address some of the flooding issues within the Basin.

The Interstate Flood Mitigation Task Force was assembled in October 2006 and is comprised of 31 members including legislative, executive, federal, state and local government agencies as well as not-for-profit organizations. Through the task force, over 45 recommendations were made for a proactive, sustainable, and systematic approach to flood risk management. Recommendations include the following areas: Reservoir operations, structural and non-structural measures, storm water management, floodplain mapping, floodplain regulations and flood warning. Some of these recommendations including the development of flood warning systems are addressed later in this report.

Products from the flood risk management task include: (1) updated stage frequency curves, (2) updated skew analysis (3) identification of ten priority communities based on a review of FEMA's repetitive and severe repetitive loss claims (4) structure inventory for priority communities and (5) potential solution matrix for priority communities. The data collected for the structure inventory is currently being used in the Delaware River Basin Comprehensive, NJ Feasibility Study, the Delaware River Basin Comprehensive, Watershed Flood Management Plan Feasibility Study and the Upper Delaware, Livingston Manor Feasibility Study. The updated stage frequency curves and skew analysis will also be used by the Corps and USGS for future studies.

**3.1 DISCHARGE-FREQUENCY ANALYSIS.** While this study was focusing efforts on updating the discharge-frequency analysis presented in Technical Appendix C of the Delaware River Basin Study Report, dated 1984, the Federal Emergency Management Agency (FEMA) had requested that the U.S. Geological Survey (USGS) update the frequency discharge values as a result of the three major flood events from September 2004 to June 2006 so that the flood insurance studies could be updated accordingly.

In order to prevent a duplication of efforts, the Corps in cooperation with USGS, FEMA, NJDEP and DRBC worked together to update the discharge-frequency analysis for eight gaging stations on the Delaware River. These stations are identified in Table 3.1.

Table 3.1  
Updated Delaware River Gaging Stations

USGS Station Number	Station name	Drainage area, (mi <sup>2</sup> )	Period of record, in water years <sup>1</sup>
01427410	Delaware River near Callicoon, N.Y. <sup>2</sup>	1,708	1968-1975
01427510	Delaware River at Callicoon, N.Y. <sup>2</sup>	1,820	1976-2006
01428500	Delaware River above Lackawaxen River near Barryville, N.Y.	2,020	1941-2006
01434000	Delaware River at Port Jervis, N.Y.	3,070	1904-2006
01438500	Delaware River at Montague, N.J. <sup>3</sup>	3,480	1904, 1936-2006
01440200	Delaware River near Delaware Water Gap, Pa.	3,850	1955, 1964-1996, 2002-2006
01446500	Delaware River at Belvidere, N.J.	4,535	1904, 1923-2006
01457500	Delaware River at Riegelsville, N.J.	6,328	1841, 1904, 1907-2006
01462000	Delaware River at Lambertville, N.J. <sup>3</sup>	6,680	1898-1907
01463500	Delaware River at Trenton, N.J. <sup>3</sup>	6,780	1904, 1913-2006

<sup>1</sup>Water years run from October 1 to September 30 and are designated by the ending year.

<sup>2</sup>Records for station 01427410 and 01427510 were combined for the analysis for 01427510.

<sup>3</sup>Records for station 01462000 and 01463500 were combined for the analysis for 01463500.

Procedures prescribed from both the Water Resources Council “Guidelines for Determining Flood Flow Frequency” (commonly referred as Bulletin 17B) and EM 1110-2-1415, “Hydrologic Frequency Analysis” were used to calculate the frequency discharges. The computer program HEC-SSP was used for the flood frequency analysis on both regulated and unregulated annual peak discharges at each of the gage locations.

The USGS and Corps agreed to use the station skew in the analysis for all gages rather than a generalized skew because the drainage areas to these gages are large, the regional skew coefficients previously developed for the Basin were outdated, and the fact that the period of record on most of the gages was greater than 50 years.

However, as part of this study, HEC conducted a generalized skew study in order to update the old regional skew maps. HEC last did a basin wide regional skew analysis in 1983 (HEC, Special Projects Memo No. 83-1) and the USGS and Corps agreed that the skew coefficients from the 1983 HEC study were outdated due to the changes within the basin. Generalized skew coefficients were completed for a discharge-frequency analysis both at gages sites and at ungaged sites.

As previously mentioned, the one notable difference with the Corps' and USGS' analysis procedures was how the Corps accounted for upstream regulation at the gage locations. Numerous reservoirs exist within the Delaware River Basin which have affected peak flows since the early 1900s down to the city of Trenton.

The procedure used for determining the effects of reservoirs on downstream discharge-frequencies is to adjust the frequency curve so as to reflect the reduction of peak flows due to operation of the reservoirs. Prior to calculating frequencies, the effects of the reservoirs on the downstream annual peak discharges have to be quantified in an analysis and the discharges need to be converted from regulated to unregulated conditions. The frequency analysis is done on the unregulated peak discharges and then re-adjusted from unregulated to regulated conditions.

Three rainfall-runoff hydraulic models previously developed by the U.S. Army Corps of Engineers, Hydrologic Engineering Center (HEC) for the calculation of the Standard Project Flood (SPF) for the Delaware River Basin were used in this analysis. The three models were divided up by major basins. The Upper Delaware Basin model went from the headwaters to the USGS gage at Montague. The Lower Delaware Basin model went from the Montague to Trenton gage, and the third model was for the Lehigh River Basin. Refer to SPM 82-9 from HEC entitled Standard Project Flood Development, Delaware River Basin for a full description.

The models were modified from their original state to simulate multiple storms, and reservoirs coded in the input files of these three models were removed in order to simulate unregulated or natural flow conditions. The year when storage started was obtained for each reservoir in the model and a new simulation was done as each individual reservoir started to store water. Summaries of the reservoirs used are shown in Table 3.2.



Table 3.2  
Reservoirs Simulated in Rainfall-Runoff Models

<b>Reservoir</b>	<b>Model</b>	<b>State</b>	<b>Storage Start Water Year</b>
Hopatcong	Lower Delaware	NJ	1825
Wallenpaupack	Upper Delaware	PA	1926
Rio	Upper Delaware	NY	1926
Toronto	Upper Delaware	NY	1926
Swinging Bridge	Upper Delaware	NY	1930
Neversink	Upper Delaware	NY	1953
Pepacton	Upper Delaware	NY	1954
Wild Creek <sup>1</sup>	Lehigh	PA	1959
Penn Forest <sup>1</sup>	Lehigh	PA	1959
Jadwin	Upper Delaware	PA	1960
Prompton	Upper Delaware	PA	1960
FE Walter	Upper Delaware	PA	1961
Cannonsville	Upper Delaware	NY	1963
Beltzville	Lehigh	PA	1971
Nockamixon	Lower Delaware	PA	1974

<sup>1</sup>Penn Forest & Wild Creek are combined in Models as one reservoir

Simulations were conducted with and without the reservoirs in place in order to develop a relationship between regulated and unregulated annual peak discharges. It was assumed for this analysis that the reservoirs were full at the beginning of each storm. Model results were graphed and a linear regression analysis was done in order to develop a mathematical equation to apply to the regulated annual peak discharges obtained from the USGS.

Results of the regression analysis were compared to the similar regression analysis summarized in the 1984 Report. The comparison showed that the updated analysis agreed very closely with the original analysis done for the 1984 Report. It would be expected that there would be some differences between the regression equations developed between the two analyses because of the longer period of record incorporated in the updated analysis.

As previously mentioned, the computer program HEC-SSP was used to calculate the unregulated frequency-discharge curve. Once this curve was developed at each gage location, the curve was re-adjusted back to a regulated condition. The re-adjusted curve at each gage location for the regulated discharge analysis was compared to the USGS analysis at each gage location. The differences between the Corps and the USGS generally were within five percent of each other and can generally be contributed to the conversion of the regulated annual peaks to an unregulated condition and then readjusted back to a regulated condition at the end. The Corps also did an independent analysis in which upstream regulation was not accounted for. This independent analysis basically followed the USGS' analysis procedures using the same exact annual peak discharges with the only difference between the two being the computer programs used. The USGS

used the program PEAKFQ (Flynn and others, 2006) and the Corps used the program HEC-SSP. The results of the Corps' analysis agreed with the USGS' results. Therefore, the minor differences between the two are directly related to the linear regression analysis of converting regulated annual peaks to unregulated annual peaks and not related to the computer program being used. Given the nature of a linear regression analysis and the assumptions that went into the HEC-1 simulations, the five percent difference between the two agencies would be expected.

The results of the Corps' and USGS' analyses were presented at a Delaware River Coordinating meeting which included representatives of the Corps, USGS, FEMA, FEMA contractors, Delaware River Basin Commission, New Jersey Department of Environmental Protection, the Commonwealth of Pennsylvania, and New Jersey Highlands Council. The Committee agreed to adopt the proposed flood frequency figures developed by USGS for use in on-going flood insurance studies and Corps' flood studies. The adopted flood frequency is summarized in Table 3.3.

Table 3.4 compares the updated flood frequency against the flood frequencies published in the 1984 COE Report. There are no values for Callicoon from 1984 because the 1984 COE Report did not include Callicoon in its study area. As Table 3.4 shows, the discharges increased for all gages for the 2- to the 50-year events from the previously published values in the 1984 COE Report except for the 50-yr event at Barryville which decreased slightly by 1,000 cfs. Discharges from the 100-yr up to the 500-yr decreased at the Trenton, Riegelsville, and Barryville gages, but increased at the Port Jervis, Montague, and Delaware Water Gap gages. These increased discharges will produce higher damages than those reported in 1984 and will therefore assist in potentially providing greater potential benefits from flood damage reduction efforts.

Table 3.5 summarizes the peak discharges at each gage location associated with historical flood events including the August 1955 flood of record, and the recent events of September 2004, April 2005, and June 2006. Utilizing the updated flood frequency shows that the September 2004 flood ranged from a 20- to 35-year event, the April 2005 flood ranged from a 40- to 70-year event, and the June 2006 flood ranged from a 70- to 100-year event along the Delaware River.

Table 3.3.  
Adopted Regulated Discharge Frequency Values for the Delaware River<sup>1</sup>

USGS Station Number	Station Name	Recurrence Interval							
		2-year	5-year	10-year	25-year	50-year	100-year	200-year	500-year
01427510	Delaware River at Callicoon, N.Y.	40,100	62,300	78,600	101,000	118,000	137,000		185,000
01428500	Delaware River above Lackawaxen River near Barryville, N.Y.	44,100	67,100	83,600	106,000	124,000	142,000		188,000
01434000	Delaware River at Port Jervis, N.Y.	59,500	91,000	114,000	147,000	173,000	201,000		273,000
01438500	Delaware River at Montague, N.J.	65,200	101,000	127,000	164,000	194,000	226,000		308,000
01440200	Delaware River near Delaware Water Gap, PA.	71,800	110,000	139,000	178,000	210,000	244,000		332,000
01446500	Delaware River at Belvidere, N.J.	76,900	116,000	145,000	184,000	215,000	248,000		334,000
01457500	Delaware River at Riegelsville, N.J.	92,300	136,000	167,000	208,000	241,000	274,000		358,000
01463500	Delaware River at Trenton, N.J.	94,900	138,000	169,000	211,000	245,000	280,000		372,000

<sup>1</sup>Schopp, R.D., and Firda, G.D., 2008, Flood magnitude and frequency of the Delaware River in New Jersey, New York, and Pennsylvania: U.S. Geological Survey Open-File Report 2008-1203.

Table 3.4.  
Comparison of Adopted Flood Frequencies Against 1984 Flood Frequencies

USGS Station Number	Station Name	Date of Analysis	Recurrence Interval (cfs)									
			2-year	5-year	10-year	20-year	25-year	50-year	100-year	200-year	500-year	
1427510	Callicoon, NY	1984										
		2008	40,100	62,300	78,600		101,000	118,000	137,000		185,000	
1428500	Barryville, NY	1984	42,000	62,000	78,000	97,000		125,000	150,000	180,000	230,000	
		2008	44,100	67,100	83,600		106,000	124,000	142,000		188,000	
1434000	Port Jervis, NY	1984	49,000	71,000	88,000	110,000		140,000	170,000	205,000	270,000	
		2008	59,500	91,000	114,000		147,000	173,000	201,000		273,000	
1438500	Montague, NJ	1984	53,000	76,000	95,000	118,000		150,000	183,000	220,000	290,000	
		2008	65,200	101,000	127,000		164,000	194,000	226,000		308,000	
1440200	Del. Water Gap, PA	1984	57,000	83,000	103,000	127,000		165,000	200,000	240,000	310,000	
		2008	71,800	110,000	139,000		178,000	210,000	244,000		332,000	
1446500	Belvidere, NJ	1984	64,000	94,000	118,000	145,000		190,000	230,000	275,000	350,000	
		2008	76,900	116,000	145,000		184,000	215,000	248,000		334,000	
1457500	Riegelsville, NJ	1984	73,000	110,000	137,000	175,000		230,000	278,000	330,000	410,000	
		2008	92,300	136,000	167,000		208,000	241,000	274,000		358,000	
1463500	Trenton, NJ	1984	76,000	117,000	145,000	183,000		238,000	288,000	340,000	420,000	
		2008	94,900	138,000	169,000		211,000	245,000	280,000		372,000	

Table 3.5  
Peak Discharges from Historical and Recent Flood Events on the Delaware River

<b>USGS Station Number</b>	<b>Station Name</b>	<b>Drainage Area (sq. mi)</b>	<b>Oct 1903 (cfs)</b>	<b>Mar 1936 (cfs)</b>	<b>Aug. 1955 (cfs)</b>	<b>Sept. 2004 (cfs)</b>	<b>Apr. 2005 (cfs)</b>	<b>Jun. 2006 (cfs)</b>
1427510	Callicoon, NY	1,820				107,000	112,000	144,000
1428500	Barryville, NY	2,020			130,000	112,000	118,000	151,000
1434000	Port Jervis, NY	3,070	205,000	137,000	233,000	151,000	166,000	180,000
1438500	Montague, NJ	3,480	217,000	164,500	250,000	168,000	206,000	212,000
1440200	Del. Water Gap, PA	3,850			260,000	176,000	215,000	225,000
1446500	Belvidere, NJ	4,535	250,000	179,000	273,000	184,000	226,000	225,000
1457500	Riegelsville, NJ	6,238	275,000	237,000	340,000	216,000	262,000	254,000
1463500	Trenton, NJ	6,780	295,000	227,000	329,000	201,000	242,000	237,000

### 3.2 SKEW ANALYSIS

As part of this study, the Philadelphia District contracted with the Hydrologic Engineering Center (HEC) to conduct a generalized skew study for the Delaware River Basin. HEC last did a basin wide regional skew analysis in 1983 (HEC, Special Projects Memo No. 83-1) and the USGS and Corps agreed that the skew coefficients from the 1983 HEC study were outdated due to the changes within the basin.

The following paragraphs were taken from the Executive Summary of the “Delaware River Basin Regional Skew Analysis Report” from HEC. At the present time, the report is still in draft form and is being reviewed by Philadelphia District personnel. Upon final review, the report will be shared with all four USGS District Offices within the Basin and can be provided upon request to other interested parties.

*The purpose of the report was to recommend, and describe methods for estimating, regional skew values required by Bulletin 17B to develop frequency curve estimates. As suggested in Bulletin 17B, candidate regional skew estimates are calculated by applying area averaging, isoline mapping, and regression methods to skew estimates from gages within a defined region, and the regional skew estimate with the smallest mean square error (MSE) selected. The District’s analysis will include development of frequency curves and flow quantities at a given location. Bulletin 17B states that a weighted skew value should be used in the log-Pearson III frequency distribution fitting parameters used to develop frequency functions of annual peak flows. Weighted skew is computed by weighting regional skew and station (gage) skew values inversely proportional to their mean square errors of estimation.*

*Regional skew analysis methods use data from independent streamgage sites in a region to estimate regional skew values. Use of multiple streamgage sites approximates an analysis based on a much longer period of record. The approach exchanges space for time, reducing time-based sampling error in the skew estimate, while introducing a lesser spatial sampling error.*

*The current regional skew values for the Delaware River Basin are considered out of date. HEC originally completed a regional skew study in 1983 entitled "Generalized Skew Study of the Delaware River Basin" (USACE 1983). In the twenty-five years since that study’s completion, more annual peak flows have been recorded and the methods for determining regional skew values have been updated. The purpose of this study is to update the regional skew values for the Delaware River Basin.*

*HEC was tasked with gathering streamgage data for the greater Delaware River Basin, and completing a regional skew analysis using three methods:*

- *Method 1: Region area-average skew. (This method was implemented three ways: Method 1a - average skew of the entire basin; Method 1b - average skews of*

*homogeneous regions (defined geographically and verified with L-moment analysis); Method 1c – Generalized Least Squares (GLS) consistent regression defined geographically using L-moment analysis.)*

- *Method 2: Skew isoline map.*
- *Method 3: Predictive equations using GLS regression.*

*To complete the regional skew study of the Delaware River Basin, HEC did the following tasks:*

- *Updated annual peak records for 215 streamgauge records. These streamgages were considered in the previous regional skew study of the Delaware River Basin (USACE 1983). This task included collecting streamgauge data from 1983 through the 2006 water year and verifying seven watershed parameters: drainage area, ten to eighty-five percent slope, basin length, mean basin elevation, percent lake storage, percent forested area, and mean annual precipitation (MAP).*
- *Gathered annual peak data - recorded through the 2006 water year - for an additional 477 streamgages in and around the Delaware River Basin. These gages were not included in the original 1983 study because they either did not exist at that time, or failed to meet the criteria specified in the 1983 study.*
- *Analyzed these 692 records to ensure data quality and homogeneous records, and eliminated 444 streamgages because of tidal or anthropogenic effects. This was done by noting USGS codes in the peak flow record, and comparing mean, standard deviation, and skew to drainage area for remaining gages. The slope and  $R^2$  values from a linear regression of annual peak flows to water year were also examined.*
- *Calculated sample statistics, including station skew values, for the remaining 248 streamgages considered in this study using Bulletin 17B procedures. Special attention was given to records with historical information, as peaks that are historically weighted can have a significant impact on station statistics.*
- *Narrowed the list to 163 streamgages using the following criteria: absence of anthropogenic effects (regulation, urbanization, and so on); minimum of twenty-five years of systematic record length; the streamgauge is located within the Delaware River Basin, or has a majority of its watershed within twenty-five miles of the basin; less than ten percent of the watershed is urbanized; and the gage is absent of tidal effects.*
- *Verified, and in some cases determined, watershed parameters for the 163 streamgages.*
- *Calculated regional average skew and MSE for these 163 streamgages (Method 1a).*
- *Determined eleven plausibly homogeneous regions of average skew using river subbasins (Method 1b and Method 1c). Region heterogeneity and streamgauge discordance statistics were calculated to find acceptably homogeneous regions. Computed average and weighted average skew for those regions.*
- *Developed, and calculated MSE for, a regional skew contour map using inverse distance weighting, modified using engineering judgment based on basin physiography and hydrology (Method 2).*
- *Calculated regional skew coefficients and their average prediction errors using a GLS procedure (Method 1c and Method 3). The GLS procedure used gages for which watershed parameters were available.*

*HEC used 163 streamgages - 115 of the gages used in the 1983 study and an additional forty-eight gages - in completing this study. Each streamgage has at least twenty-five years of unregulated annual peak flows whose records are considered absent of both tidal and anthropogenic effects per Bulletin 17B guidelines.*

*Averaging all 163 station skews into a single region resulted in a regional average skew of 0.184, and MSE of 0.142. This Bulletin 17B recommendation for estimating MSE assumes that all gage skew values are perfectly estimated. An estimate of MSE equal to 0.241 was obtained using Monte Carlo simulation to include the sampling error of gage skew estimates (Method 1a).*

*For the homogeneous regions HEC verified using L-moment analysis (Hosking and Wallis, 1997) the weighted-average skew (weighted by the number of gages in a region) for all gages was 0.181, the MSE was 0.133, and the simulated MSE (including time-sampling error) was 0.232. The weighted-average skew for gages within the Delaware River Basin was 0.221, the MSE was 0.146, and the simulated MSE was 0.251 (Method 1b).*

*HEC completed a GLS regression of the regions using only a constant, effectively obtaining regional average skew values. The constant provides a direct comparison with the regional average obtained using standard methods outlined above, while also accounting for inter-gage correlation and differences in gage record length. In this approach, average variance of prediction (AVP) is used as a measure of prediction error in place of MSE and simulated MSE. The GLS-consistent region area-average approach results in a weighted-average constant (based on the number of gages in a region) of 0.151, which would be used as the regional skew value. The method has a weighted-average AVP of 0.044 (Method 1c).*

*A skew isoline map was developed by calculating skew isolines using an inverse distance squared interpolation. The isolines were then modified using engineering judgment based on consideration of region physiography and hydrology. The MSE for this skew isoline map was 0.147 (Method 2).*

*GLS regression of all gages in the Delaware River Basin resulted in no regression model prediction error, with all error attributed to limited record length. This was felt to be an unreasonable result because no model error implies a perfect regression model prediction if the gage skew values were perfectly estimated i.e., no sampling error. This is unlikely to occur in skew prediction. More significant results were achieved, however, by dividing the basin into northern and southern regions. A regression using only mean elevation identified a regression model error and had an AVP equal to 0.027 for the northern region. A regression using mean annual precipitation resulted in an AVP of 0.019 for the southern region, but no regression model error could be defined (Method 3).*



## **Recommendation**

*For determining a regional skew for the Delaware River basin, HEC recommends the results of Method 1c (see page 2). This method (based on homogeneous regions verified by L-moment analysis) yields region skew values that average to GLS regression constant of 0.151. This has a corresponding AVP of 0.044. The GLS-consistent method is recommended because:*

- *The simplicity of using only a constant and the comparably small AVP makes this method preferable to the GLS regression equations or skew contour map.*
- *The method produces improvements to the recommendations of Bulletin 17B, as presented in this report.*
- *The minimum error of the method, AVP, will promote the greatest consistency in the application of the Bulletin 17B guidelines.*

### **3.3 IDENTIFICATION OF PRIORITY COMMUNITIES**

In order to conduct a meaningful structure inventory the team used the same 147 sub-basin delineation as was used for the water supply task. Selection of this scale was appropriate for this regional study of the Delaware River Basin as it will provide a more detailed regional picture than what has been done before for the basin with previous studies and will show the regional magnitude and location of areas which have suffered repetitive flood damages in the past. Table 2.2 lists the basins with their major streams.

Once the basins were identified, an analysis of FEMA-designated repetitive and severe repetitive loss properties in the Delaware River Basin was conducted to identify critical floodprone areas. The analysis was based upon data received from FEMA regarding closed claims processed as part of the National Flood Insurance Program from January 1, 1978 to February 28, 2007. A limitation of the analysis is that it does not consider flood damages from uninsured structures. The analysis separately considered repetitive loss and severely repetitive loss structures. A repetitive loss property as defined by FEMA is a property that suffers two or more losses in which FEMA paid more than \$1,000 for each loss. The losses also must be within 10-years of each other and be at least 10 days apart. A severely repetitive loss property as defined by FEMA is a property that suffers four or more losses with each loss exceeding \$5,000 or when there are two or more losses in which the payout exceeded the property value.

The number of properties along with the dollar amounts in payouts made by FEMA were tabulated by basin. The categories used to evaluate each basin were:

- The number of structures.
- The number of structures per basin square mile.
- The total amount of payouts made.
- The total amount of payouts made per basin square mile.

Rankings were assigned for each category with a ranking of “1” being assigned to the basin with the highest value. A composite ranking for each basin was computed by

taking an average ranking for all four categories combined. This was done for both repetitive loss and severely repetitive loss databases.

GIS was used extensively in the analysis. GIS was used to aggregate all of the individual claims by basin in order to come up with the number of claims and payout amounts by basin. GIS was also used to segregate the basin-wide claim data by municipality within each basin and was used to create all the maps. The data was segregated by municipality within each basin for informative purposes since some municipalities exist in two or more basins. Data was not aggregated strictly by municipality. That analysis was previously done by DRBC and can be found on their website. Tables 3.6-3.7 summarize the highest ranked basins for repetitive losses and severely repetitive losses respectively. Figures 3.3-3.4 graphically show the highest ranked basins for each database.

Table 3.6  
Repetitive Loss Rankings By Basin

Basin	No. of Properties	Total Payouts	No. of Properties By Basin Sq. Mi.	Total Payouts By Basin Sq. Mi.	No. of Properties Ranking	Total Payout Ranking	No. of Properties By Basin Sq. Mi. Ranking	Total Payouts By Basin Sq. Mi. Ranking	Overall Ranking
DB-076	397	\$52,691,594	6.34	\$841,665	1	1	1	1	1.0
DB-072	179	\$18,464,204	2.86	\$294,819	3	3	2	2	2.5
DB-089	120	\$15,429,533	2.14	\$274,527	6	4	5	3	4.5
DB-109	166	\$21,277,991	1.28	\$164,560	4	2	9	8	5.8
DB-053	106	\$11,976,080	2.21	\$249,450	8	8	4	4	6.0
DB-077	268	\$10,940,292	2.80	\$114,362	2	9	3	11	6.3
DB-054	112	\$15,126,778	1.40	\$189,314	7	5	7	7	6.5
DB-110	87	\$13,186,735	1.37	\$207,062	10	7	8	6	7.8
DB-112	126	\$7,167,101	1.54	\$87,871	5	13	6	18	10.5
DB-123	54	\$13,771,330	0.96	\$245,697	18	6	14	5	10.8
DB-078	67	\$7,967,387	1.24	\$147,531	12	12	11	10	11.3
DB-068	56	\$8,612,556	0.96	\$148,007	16	10	15	9	12.5
DB-084	88	\$6,343,133	1.28	\$92,426	9	15	10	16	12.5
DB-115	74	\$6,702,501	1.12	\$101,005	11	14	13	13	12.8
DB-091	63	\$4,654,591	1.23	\$90,740	14	21	12	17	16.0
DB-074	39	\$5,883,983	0.72	\$108,068	22	16	16	12	16.5
DB-125	33	\$8,076,020	0.39	\$95,063	27	11	24	15	19.3
DB-013	54	\$3,436,102	0.59	\$37,560	18	24	18	24	21.0
DB-048	38	\$5,397,398	0.35	\$50,371	23	19	27	20	22.3
DB-075	33	\$4,898,234	0.43	\$63,257	27	20	23	19	22.3
DB-104	62	\$3,910,506	0.44	\$27,996	15	23	22	29	22.3
DB-083	41	\$2,136,254	0.63	\$32,837	21	32	17	26	24.0
DB-067	55	\$3,313,206	0.37	\$22,281	17	25	25	34	25.3
DB-108	43	\$2,337,306	0.51	\$27,834	20	31	20	31	25.5
DB-120	67	\$2,135,957	0.54	\$17,314	12	33	19	40	26.0
DB-045	28	\$5,498,886	0.25	\$48,302	32	18	39	21	27.5
DB-052	37	\$1,979,449	0.49	\$26,397	24	34	21	32	27.8
DB-079	32	\$5,517,496	0.22	\$38,241	29	17	42	23	27.8
DB-069	29	\$2,712,147	0.36	\$33,216	31	30	26	25	28.0
DB-073	34	\$3,161,101	0.30	\$28,185	26	26	32	28	28.0

Table 3.7  
Severely Repetitive Loss Rankings By Basin

Basin	No. of Properties	Total Payouts	No. of Properties By Basin Sq. Mi.	Total Payouts By Basin Sq. Mi.	No. of Properties Ranking	Total Payout Ranking	No. of Properties By Basin Sq. Mi. Ranking	Total Payouts By Basin Sq. Mi. Ranking	Overall Ranking
DB-076	92	\$25,988,539	1.19	\$335,622	1	1	1	1	1.0
DB-054	38	\$8,106,996	0.79	\$168,861	3	3	2	2	2.5
DB-109	48	\$12,846,708	0.37	\$99,354	2	2	3	3	2.5
DB-053	26	\$4,705,687	0.35	\$62,752	4	7	4	5	5.0
DB-072	23	\$5,020,966	0.24	\$51,745	5	6	7	7	6.3
DB-084	18	\$2,247,034	0.28	\$34,539	6	13	5	12	9.0
DB-110	13	\$2,555,940	0.20	\$40,134	8	12	8	9	9.3
DB-089	14	\$2,713,750	0.17	\$33,818	7	9	10	13	9.8
DB-123	7	\$5,567,367	0.12	\$99,329	18	4	13	4	9.8
DB-091	11	\$2,567,091	0.17	\$39,066	10	11	11	11	10.8
DB-078	9	\$5,203,179	0.09	\$54,390	12	5	21	6	11.0
DB-074	13	\$3,513,572	0.12	\$31,328	8	8	15	15	11.5
DB-048	8	\$1,511,456	0.26	\$50,033	16	21	6	8	12.8
DB-051	9	\$1,640,927	0.18	\$33,501	12	17	9	14	13.0
DB-067	11	\$2,031,296	0.13	\$24,249	10	15	12	18	13.8
DB-115	4	\$2,633,487	0.06	\$39,686	27	10	24	10	17.8
DB-069	7	\$1,235,621	0.12	\$21,234	18	22	14	19	18.3
DB-075	6	\$1,669,901	0.11	\$30,670	23	16	18	16	18.3
DB-079	6	\$1,621,487	0.11	\$30,025	23	18	17	17	18.8
DB-108	9	\$968,301	0.11	\$11,531	12	26	19	24	20.3
DB-112	8	\$1,191,609	0.10	\$14,609	16	23	20	22	20.3
DB-077	7	\$858,845	0.11	\$13,719	18	27	16	23	21.0
DB-013	9	\$1,056,942	0.07	\$7,980	12	24	23	27	21.5
DB-068	7	\$1,584,089	0.05	\$10,653	18	20	26	25	22.3
DB-045	7	\$1,595,726	0.04	\$9,173	18	19	28	26	22.8
DB-073	3	\$972,742	0.05	\$15,532	31	25	25	21	25.5
DB-124	3	\$2,159,247	0.03	\$20,762	31	14	38	20	25.8
DB-104	6	\$836,559	0.04	\$5,989	23	28	27	33	27.8

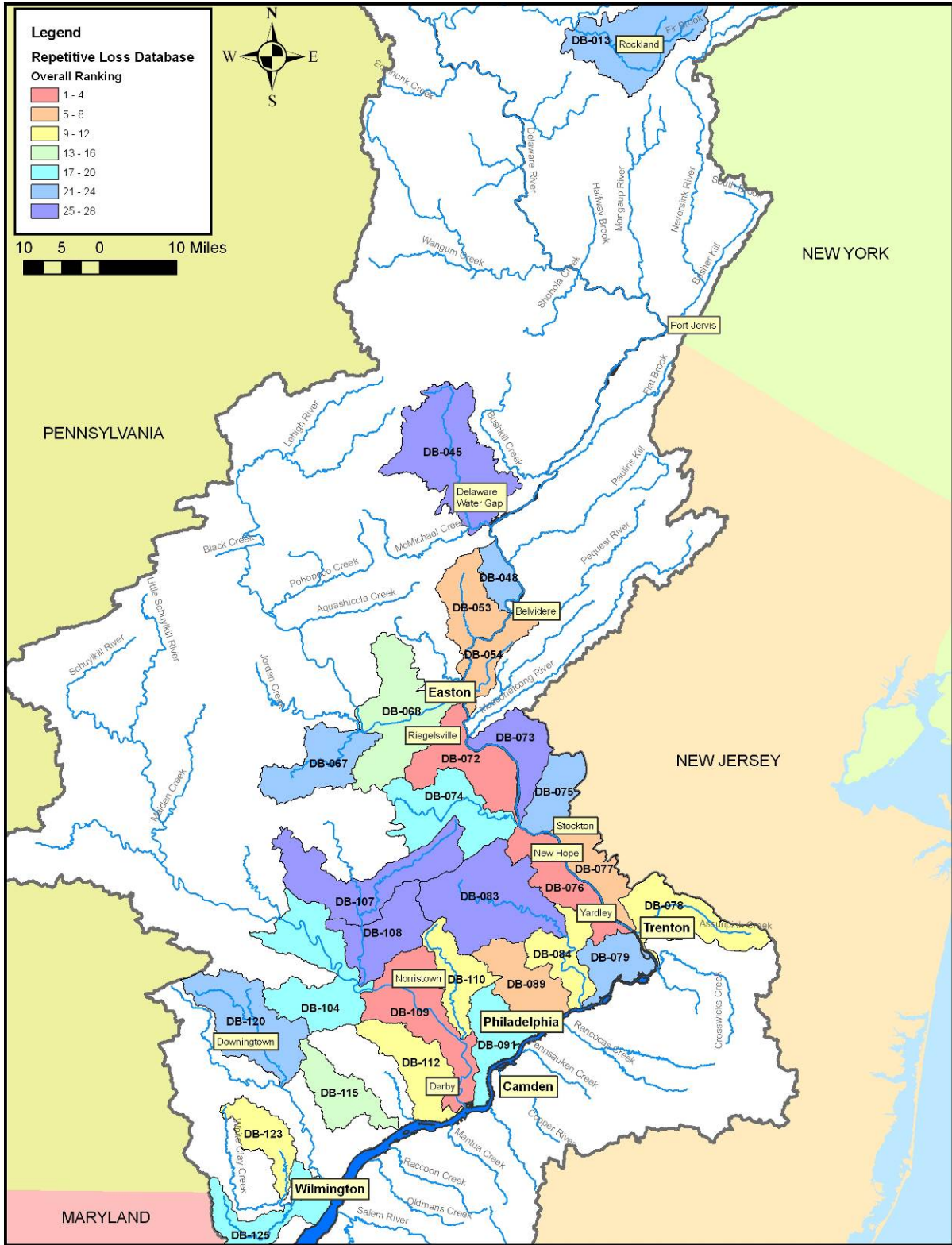

Figure 3.3 Highest Repetitive Loss Rankings by Basin

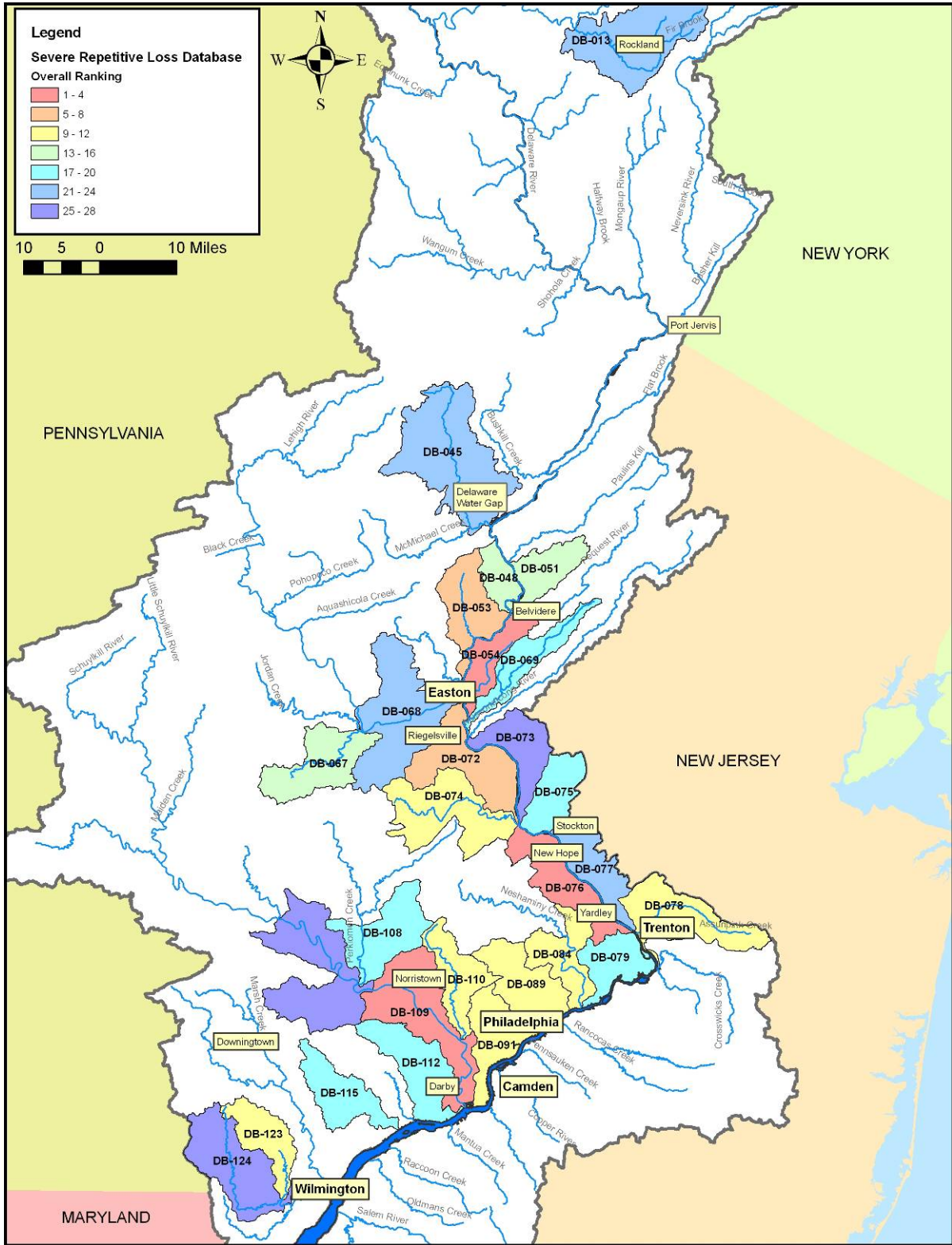

Figure 3.4 Highest Severe Repetitive Loss Rankings by Basin

Basin DB-076 had both the highest repetitive and severely repetitive losses in the analysis by a large margin over other basins. Basin DB-076 is in Pennsylvania along the Delaware River and includes Lower Makefield, Upper Makefield, Solebury Townships along with the Boroughs of New Hope and Yardley. There were a total of 397 repetitive loss claims totaling \$52.7 million dollars. The same basin had a total of 92 severe repetitive loss property claims that totaled close to \$26 million dollars. These claims were from 1978 to 2007. The next closest basin for repetitive loss claims was DB-072 which had 179 property claims totaling \$18.4 million dollars. Basin DB-072 is along the Delaware River and includes the townships of Bridgeton, Durham, Tinicum, and Williams in Bucks and Northampton counties in Pennsylvania. Basin DB-054 was the second highest severely repetitive loss basin in the analysis with 38 property claims totaling \$8 million. It is along the Delaware River and covers the townships of Harmony and Pohatcong along with the city of Phillipsburg in New Jersey. Table 3.8 shows a breakout of the top ten municipalities in the basin with the highest number of designated loss properties.

Table 3.8  
Repetitive & Severe Repetitive Loss Claims

Top Ten Municipalities in the Basin with Highest Number of Designated Loss Properties:

Municipality	Repetitive Loss Properties	Total Payouts for Repetitive Loss Properties	Municipality	Severe Repetitive Loss Properties	Total Payouts for Severe Repetitive Loss Properties
Trenton, NJ	176	\$11,459,971	Yardley, PA	46	\$11,206,158
Yardley, PA	170	\$19,282,322	West Norriton, PA	34	\$5,580,246
Philadelphia, PA	95	\$7,471,828	Harmony, NJ	29	\$5,878,462
New Castle, DE	86	\$18,101,486	Upper Makefield, PA	21	\$5,872,833
Harmony, NJ	76	\$11,095,956	Plumstead, PA	13	\$3,513,572
West Norriton, PA	76	\$7,493,477	Forks, PA	12	\$2,858,239
New Hope, PA	71	\$10,208,886	Middletown, PA	12	\$1,578,207
Upper Makefield, PA	66	\$10,682,761	Allentown, PA	11	\$1,685,403
Lambertville, NJ	64	\$3,348,860	Rockland, NY	10	\$1,760,483
Bridgeton, PA	59	\$6,048,814	Solebury, PA	10	\$4,436,010

Notes:

1. A property is considered a repetitive loss property by FEMA when there are 2 or more losses reported which were paid more than \$1,000 for each loss. The 2 losses must be within 10 years of each other and be at least 10 days apart.
2. A property is considered a severe repetitive loss property by FEMA either when there are at least 4 losses each exceeding \$5000 or when there are 2 or more losses where the building payments exceed the property value.
3. Claims were mapped and summaries compiled using Lat/Long coordinate points provided by FEMA. On occasion, the Lat/Long location does not match the FEMA assigned community name for specific claims.
4. Information was compiled by DRBC staff, April 2007. A complete analysis table is available online at [http://www.state.nj.us/drbc/Flood\\_Website/floodclaims\\_home.htm](http://www.state.nj.us/drbc/Flood_Website/floodclaims_home.htm)
5. This analysis does not capture uninsured flood damage.

Based on the results of these claims and discussions with Federal, state and local agencies, the towns of Yardley, New Hope, Easton and Upper Makefield, PA; Lambertville, Stockton, Belvidere and Harmony, NJ; and Rockland and Colchester, NY were identified as priority sites for flood risk management efforts. The locations of these ten communities are displayed on the map in Figure 3.5.



Figure 3.5 Key Flood Prone Areas used for Structure Inventories and Solution Matrix



### 3.4 STRUCTURE INVENTORY FOR 10 PRIORITY COMMUNITIES

The structure inventory conducted for these ten communities accounted for nearly 25% of the total project cost and almost 50% of the flood risk management task. The structure inventory was essential for advancing the efforts of three other studies and assisting locals in the evaluation of potential projects.

The inventory was conducted for all residential, commercial and industrial structures within the 100-year floodplain for the ten priority communities, totaling approximately 1,900 structures. Table 3.6 shows a breakdown of the number of structures per community.

Table 3.6  
Summary of Structure Inventory

Community	Number of Structures Inventoried
Pennsylvania	
Yardley	302
New Hope	155
Upper Makefield	366
Easton	99
New Jersey	
Lambertville	175
Harmony	146
Stockton	131
Belvidere	93
New York	
Rockland	338
Colchester	70

The structure inventory involved locating structures in the 100 year floodplain on an aerial photograph such as shown in Figure 3.6. Each structure inventoried was photographed and given a unique structure identification number which was then placed into a Geographic Information System (GIS) database. Data collected for each structure consisted of ground, first floor and zero damage elevations and sufficient data to determine depreciated replacement costs using the Marshall & Swift Residential and Commercial Estimator programs and a May 2008 Price Level. Data input included such things as number of stories, square footage, quality, basement, garages, exterior (siding, brick) etc.

Figure 3.6

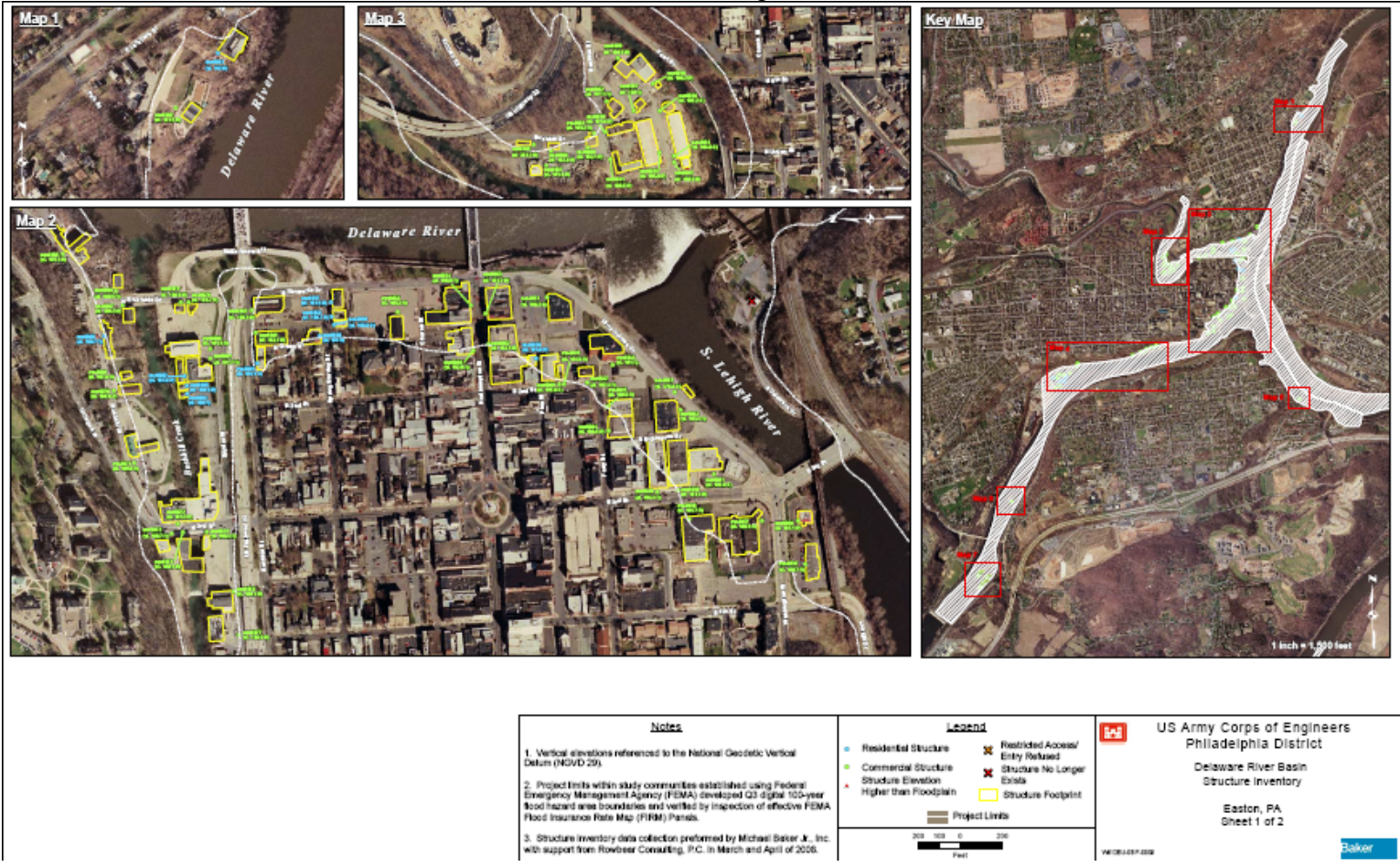

In addition to depreciated replacement costs, each structure was also assigned generic depth-damage curves. These curves are assigned to a structure based on structure type (residential or commercial) number of stories and whether a structure has a basement. The example in Table 3.10 shows the percentage of damage for structure and content for a 2 story residential structure with no basement. The first and third columns in the table show elevation relative to the first floor while the second and fourth columns show the percentage of damage based on elevation of flooding. For example, when the first floor receives one foot of water 24 percent of the structure's depreciated replacement cost is expected to be damaged while 31 percent of the contents are damaged. This data will enable the end user the ability to determine dollar damages for each structure based on the depth of flooding.

Table 3.10  
Sample Depth Damage Curve

Residential Structures S03 (2 story, no basement)		Residential Contents (S04)	
Depth (in Feet)	Damage to structure	Depth (in Feet)	Damage to contents
-2	.00	-2	0
-1	.01	-1	0
0	.10	0	.22
1	.24	1	.31
2	.30	2	.40
3	.36	3	.54
4	.39	4	.61
5	.42	5	.37
6	.47	6	.76
7	.49	7	.81
8	.56	8	.88
9	.64	9	.88
10	.67	10	.96

The data gathered for this task will ultimately enable local officials and other water resources planners the ability to estimate dollar damages for given levels of flooding. Currently this information is being used in the Delaware River Basin Comprehensive, New Jersey Study, which is being cost-shared with the New Jersey Department of Environmental Protection; the Upper Delaware Watershed, Livingston Manor Feasibility Study; and the Delaware River Basin, Watershed Flood Management Plan. The Watershed Flood Management Plan will use this information to develop flood inundation mapping for use as a planning and emergency management tool for 100+ miles of the main stem Delaware River and will be accessible within a GIS environment.

As part of this study, a series of flood events are run through the hydraulic model to compute a series of water surface profiles. The water surface profiles are then used to develop corresponding flood inundation maps and depth grids by draping the flood layer on the digital topography.

A database of structures located in frequently flooded areas (10 priority communities) in conjunction with the depth of flooding generated by each water surface profile, is used to calculate damage estimates to structure and contents for each of the buildings in the database. Damage estimates can be calculated by single structure or groups of buildings at the user's discretion or by local municipality, county, or study-wide.

The functionality of the GIS-based inundation maps centers on the user entering river stages at any of the forecast points located within the project area. A known or forecasted stage at one or more of the gage locations produces the appropriate flood inundation layer as a depth grid. Inundation depth grids, flood impact response tables, and flood damage tables are produced from the input stage. Using the depth grid and underlying base data, determination of extent and depth of flooding as it impacts buildings and transportation systems and expected damages to structures and contents are readily available through the GIS.

### **3.5 SOLUTION MATRIX**

In addition to the structure inventory, the team moved forward with problem identification and the development of a solution matrix for the ten priority communities. Problem identification began with a review of previous studies, coordination with locals and a review of flood mitigation plans (where available). Potential alternatives were evaluated for each of the ten communities and a reconnaissance level screening was conducted. Potential alternatives for these communities are outlined in Table 3.11, which provides a brief description of structural and non-structural alternatives along with a definition of each alternative and a list of pros and cons which should be considered in evaluating the alternative.

Table 3.12 then goes on to provide solutions which should be given further consideration in future studies. The matrix (Table 3.12) provides the names of each water body within the community along with potential structural and non-structural alternatives. These alternatives were developed through a literature review, discussions with local municipalities, states and other Federal agencies, engineering judgment and a review of proposed flood mitigation plans being developed for FEMA. These are just a few alternatives which should be considered.

Table 3.11  
Descriptions of Possible Alternatives

<b>STRUCTURAL METHODS:</b> Modify flooding to keep water away from specific developments and/or populated areas or to reduce flooding in such areas by constructing flood control works such as dams and reservoirs, levees and floodwalls, channel alterations, seawalls, and diversion channels				
Measure	Description	PRO	CON	Conclusions (1984 Basin Study)
Channel Modifications and Diversions	Channel modification involves widening, deepening or straightening of existing channels and the modification of highway and railroad bridges that constrict the channel.	1.) Flood levels could be reduced through channel modifications 2.) For most of the river, the effect of existing bridges on flood flows is minimal	1.) The Delaware River through the study area maintains a very mild slope throughout most of its length, limiting the effective flow carrying capacities of any channel modifications. 2.) Significant reduction to flood levels would require extensive excavation, relocations, and acquisition of additional lands, all at high costs 3.) Channelizing only portions of the river would move flood waters more rapidly downstream, thereby accentuating problems in affected areas. 4.) The proximity of developed property to the stream bank would require the acquisition of some of that property considered for protection. Adverse environmental effect of extensive channel modifications on fish and wildlife	Channel modifications and diversions were not considered further.
Flood or High Flow Skimming Impoundments	A flood control impoundment or lake is that area behind a dam used to collect and store flood waters thus preventing them from reaching the areas to be protected. The stored flood waters are later released at reduced (nondamaging) flow rates.	1.) For the entire Delaware River Basin, a total of 386 small and 193 major dam and reservoir sites were identified. Of those, 70 sites met minimum storage criteria of 20,000 acre-feet. Work since 1962 has resulted in the identification of 37 more project variations or sites increasing the total to 107.	1) Difficult to develop enough control to significantly lower stages on the Delaware River  2) Limited availability of land for the size of impoundment needed in order to significantly reduce flows  3) Flood skimming could adversely impact smaller streams and adjacent wetlands; need to maintain a minimum conservation flow.  4) Expensive alternative when compared to others.	All 107 sites were once again considered.

Table 3.4  
Descriptions of Possible Alternatives (Continued)

Measure	Description	PRO	CON	Conclusions (1984 Basin Study)
Levees and Floodwalls with Interior Drainage System	A levee (an earth embankment) or floodwall (a concrete wall) is constructed along the banks of a stream. They contain flood waters within the stream channel and protect the adjacent community.	<p>1.) They eliminate flood damages from storms that do not cause stream levels to rise above their design height.</p> <p>2.) Typically, levees and floodwalls are designed against rare flood events, thereby providing a high degree of protection.</p>	<p>1.) Floodwalls and levees often conflict with community plans (plans for open space, conservation, park, or recreational development of portions of flood plain lands)</p> <p>2.) Existing or potential riverfront resources could be reduced or eliminated by levees and floodwalls which preclude visual or physical access to the river</p> <p>3.) Levee/floodwall systems have been difficult to justify because of the natural and man-made characteristics of the study area</p> <p>4.) High Zero Damage Elevations (ZDE), steep banks, and the level and complexity of the infrastructure of communities being protected has resulted in high project costs with respect to potential benefits</p> <p>5.) Potential levee/floodwall alignments often contain buildings, utilities and other structures.</p> <p>6.) The interior protected areas have no room for ponding stormwater drainage, have antiquated storm drainage systems and require large-volume interior drainage systems.</p> <p>1.) Floodwalls and levees often conflict with community plans (plans for open space, conservation, park, or recreational development of portions of flood plain lands)</p>	An investigation of the economic feasibility of levees and floodwalls was conducted for all applicable damage centers.

Table 3.4  
Descriptions of Possible Alternatives (Continued)

<u>NONSTRUCTURAL METHODS:</u> Floodplain management measures that (1) modify the impact of flooding such as flood insurance or (2) modify susceptibility to flooding, such as warning/preparedness systems, floodplain regulations, floodproofing, and relocation.				
Measure	Description	PRO	CON	Conclusions (1984 Basin Study)
Flood Insurance	Flood insurance offers property owners a means of avoiding catastrophic losses due to floods. It provides for reimbursement of possible financial losses with the payment of a regular premium.	1.) In addition to financial protection, the flood insurance program encourages wise use of flood hazard lands through required flood plain zoning and building codes. These reduce future flood losses. 2.) The payment of the flood insurance premium brings the degree of flood risk to property owners' attention in one of the most direct ways short of a flood. Presumably this easily recognizable cost encourages a modified use and eventual abandonment of hazardous areas.	1.) Flood insurance does not eliminate the flood hazard. 2.) It is limited in the amount of financial loss that may be covered by policy. 3.) It does not eliminate associated costs such as cleanup required after a flood. 4.) Because the flood hazard remains, the threat to public safety and loss of life is still present. 5.) The availability of insurance and avoidance of catastrophic loss may actually encourage continued occupancy and reinvestment in the flood plain because it reduces the true risk.	From a national perspective, flood insurance is justified on the basis of proper management of flood plain lands for the future and on its social benefits. Flood insurance would be an inherent part of any plans for the study area that address residual damages.
Flood Forecasting, Warning and Preparedness Planning	Flood forecasting, flood warning, and preparedness planning are each individual components of an overall measure. Flood forecasting and flood warning have existed as part of the regular program of the National Weather Service (NWS). Flood preparedness plans should be fully documented and practiced.	1.) Flood recognition (forecast) and flood warning systems function well and are completely adequate to meet the needs of main stem Delaware River communities.	1.) The weaknesses in providing a complete system lie primarily in preparedness planning and program maintenance. 2.) Local preparedness plans are often inadequate and public concern tends to wane with time.	There are opportunities to improve existing flood recognition and flood warning arrangements from an efficiency and factor-of-safety standpoint.
Flood Plain Management	Proper management of flood plains by local communities is a delicate composition of regulatory, taxing and policy measures tailored to the specific flooding problem within a framework of total needs and desires of a community.	1.) Alternative development concepts or plans would be more rational if the consequences of future flooding were correctly incorporated in those decisions and plans.	1.) These management measures do not reduce or prevent damages to existing development but are meant to reduce or eliminate flood damages to future development.	General flood plain management requirements by local communities should be incorporated with any "basic" flood control plan being recommended.

Table 3.4  
Descriptions of Possible Alternatives (Continued)

Measure	Description	PRO	CON	Conclusions (1984 Basin Study)
Flood Proofing	Flood proofing is designed to protect damageable property from floodwaters by preventing the water from entering a structure. Flood proofing is performed by either raising the structure; providing perimeter protection (levee or floodwall) around the structure; sealing the structure; or reducing the degree of potential damage even if the structure were to be flooded.	1.) Flood problem areas throughout the study area do exist which have high zero damage elevations (ZDE) and development characteristics suitable for flood proofing. 2.) Raising is more applicable to frame construction; perimeter protection to multi-building installations or small groups of buildings; sealing to heavily constructed masonry or concrete structures; and water damage reduction techniques to almost all units.	1.) All exterior losses such as damage to grounds, utilities, roads, crops, etc. would be fully sustained. 2.) Flood Proofing is not applicable for every situation. 3.) As little as 15 percent of the existing structures in a flood plain lend themselves to a flood proofing solution (Madigan-Praeger Report).	Flood proofing was considered for all structures.
Permanent Flood Plain Evacuation	The objective of permanent evacuation is to remove people and damageable property from the flood hazard area.	1.) With the removal of flood-susceptible buildings, an opportunity exists for increasing open space, park, and recreational development; for promoting natural and conservation areas; and for advancing compatible utilization such as parking, transient storage or pedestrian malls for commercial development. 2.) Permanent evacuation, if not part of a more comprehensive community plan, can have a positive impact on a community.	1.) The removal of property can upset a neighborhood; decrease the communities' tax base; and, in general, have adverse social and economic effects.	Flood plain evacuation was investigated but solely from the perspective of flood control project investment; not as a secondary purpose.



Table 3.12  
Solution Matrix for Top 10 Priority Communities

Community	Flooding Issues	Solutions Previously Evaluated	Benefit to Cost Ratio from Previous Evaluations	Potential Alternatives to be Re-examined
<b>LAMBERTVILLE, NJ</b>				
<b>Alexauken Creek</b>	Alexauken Creek backflows through the storm sewer system and surcharges near North Union and Cherry Street when Delaware River rises above flood stage.			(1) Install backflow prevention device behind CVS Pharmacy (2) Study of sanitary sewage backflow
<b>Ely Creek</b>	Ely Creek surcharges to North Union Street flooding residential and commercial properties when Delaware River rises above flood stage.			(1) Install backflow prevention device within the Niece Lumberyard and a portable pump.
<b>Swan Creek</b>	Swan Creek surcharges onto North Union Street and vicinity when Delaware River rises above flood stage, flooding residential and commercial structures.	(1) Two new levees on Swan Creek (2) Floodproofing, raising and buyouts of structures along Swan Creek	.30 to 1 .65 to 1	(1) Install flood gate and lift station at Swan Creek.
<b>Delaware River</b>	Flooding of Lambert Lane and Cherry Street			(1) Possible raising of structures
<b>STOCKTON, NJ</b>				
	Delaware River flooding along South Main Street and Mill Street flooding Stockton Fire Department, Borough Hall and residential structures	(1) 2900' levee (2) flood proofing	(1) .07 to 1 (2) .02 to 1	(1) Relocate or floodproof Fire Department  (2) Floodproof Borough Hall

Table 3.5  
Solution Matrix for Top 10 Priority Communities (Continued)

Community	Flooding Issues	Solutions Previously Evaluated	Benefit to Cost Ratio from Previous Evaluations	Potential Alternatives to be Re-examined
<b>STOCKTON, NJ (Continued)</b>				
				(3) Residential property Acquisition of approximately 5 repetitive loss properties along Mill Street  (4) Flood proof sewer pump station  (5) Improve canal banks to serve as levee
	Backflow from Canal causes storm drains to backup along North and South Railroad Avenues			(1) Install backflow prevention device
<b>HARMONY, NJ</b>				
	Flooding along Goat Farm Road	(1)Levee (2) flood proofing, floodwall, evacuation	(1) unjustified (2) 1.81 to 1	(1) Buyout for 10 properties along Goat Farm Road (2) Debris control  (3) Potential Section 206 (Aquatic Habitat) for abandoned quarry could produce limited flood damage reduction benefits. (4) Combination of flood proofing/floodwall/evacuation

Table 3.5  
Solution Matrix for Top 10 Priority Communities (Continued)

Community	Flooding Issues	Solutions Previously Evaluated	Benefit to Cost Ratio from Previous Evaluations	Potential Alternatives to be Re-examined
<b>BELVIDERE, NJ</b>				
	Pequest Creek	(1) channel excavation & removal of 2 check dams (2) two levees on either side of Pequest (3) nonstructural measures	(1) 1.6 to 1 (2) .04 to 1 (3) .13 to 1	(1) Removal of dams  (2) channel excavation
	Pophandusing Brook			(1) Flap gates/ storm water outlets (2) Review of nonstructural flood control measures
<b>YARDLEY, PA</b>				
	Delaware River	floodproofing, elevation	.66 to 1	(1) Temporary levee/floodwall between River Road and the banks of the Delaware River (2) Flap gates and a series of pumps for interior drainage (3) Eliminate flow restriction from Conrail Embankment. (4) Raise or relocate structures above flood hazard
	Delaware Canal			(1) Repair aqueduct, improve number of wastegates, raising towpath (2) Increase capacity of overflow from Canal into Brock Creek

Table 3.5  
Solution Matrix for Top 10 Priority Communities (Continued)

Community	Flooding Issues	Solutions Previously Evaluated	Benefit to Cost Ratio from Previous Evaluations	Potential Alternatives to be Re-examined
<b>YARDLEY, PA (Continued)</b>	Delaware Canal (Continued)			<p>(3) Increase number of wastegates-additional relief gates at the canal aqueduct over Brock Creek</p> <p>(4) Raise the grade and increase stability of towpath in low areas.</p> <p>(5) Additional weirs or overflows should be considered both upstream of Yardley and in the vicinity of Lock 5</p> <p>(6) Stabilize the Canal bank opposite Silver Creek</p> <p>(7) Flood proofing techniques used to protect the residential properties from Delaware river floodwater will have coincidental benefits from flows overtopping the Canal.</p>
	Bock and Brock Creek	two levees above Brock Creek	.14 to 1	<p>(1) Debris removal (particularly in vicinity of aqueduct)</p> <p>(2) Deepening of streambed to increase flow capacity for Brock Creek may be a viable short term solution.</p> <p>(3) Need to investigate the feasibility of utilizing flood proofing techniques for residential properties.</p> <p>(4) stream restoration/increase riparian buffers</p>

Table 3.5  
Solution Matrix for Top 10 Priority Communities (Continued)

Community	Flooding Issues	Solutions Previously Evaluated	Benefit to Cost Ratio from Previous Evaluations	Potential Alternatives to be Re-examined
<b>NEW HOPE, PA</b>				
	Mainstem Delaware	Levee  5% of structures in 25 year floodplain needed floodproofing or floodwalls	0.67  1.95 to 1	(1) Temporary floodwall coupled with a permanent base and some permanent floodwalls should be investigated.  (2) Addition of permanent or temporary pumping stations
	Aquetong Creek	levees/floodwalls above and below Aquetong Creek	.20 to 1	(1) Stop gate repair on the canal near Center Bridge
	Delaware Canal			(5) May want to check Locks to ensure they are in proper working order
<b>EASTON, PA</b>				
	Mainstem Delaware	(1) Levee (2) 12% of structures in 50 year flood event needed floodproofing or floodwalls	.06 to 1 .64 to 1	(1) Flap gates/ storm water outlets
	Lehigh	(1)Flood warning system-never implemented due to lack of sponsor for O&M (2) fifteen foot sheetpile wall-provided no flood protection		(1) flood warning system

Table 3.5  
Solution Matrix for Top 10 Priority Communities (Continued)

Community	Flooding Issues	Solutions Previously Evaluated	Benefit to Cost Ratio from Previous Evaluations	Potential Alternatives to be Re-examined
<b>EASTON, PA (Continued)</b>				
	Bushkill Creek			<ul style="list-style-type: none"> <li>(1) Levee-floodwall system</li> <li>(2) flap gates/ storm water outlets</li> <li>(3) Review of potential debris blockage and limited channel modification</li> <li>(4) Raising and floodproofing</li> <li>(5) Barriers placed along the bridge should and approaches along with portable pumps</li> </ul>
<b>UPPER MAKEFIELD, PA</b>				
	Mainstem Delaware-Damages clustered at 6 locations  Houghs & Jericho Creeks	floodproofing, elevations	.87 to 1	<ul style="list-style-type: none"> <li>(1) Ring levees should be considered around damage clusters.</li> <li>(2) Temporary floodwall coupled with permanent base</li> <li>(3) Pipe extensions for flapgates/ stormwater outlets</li> <li>(4) Permanent or temporary pumping stations</li> </ul> <p>Erosion, not flooding appears to be larger problem than flooding</p>

Table 3.5  
Solution Matrix for Top 10 Priority Communities (Continued)

Community	Flooding Issues	Solutions Previously Evaluated	Benefit to Cost Ratio from Previous Evaluations	Potential Alternatives to be Re-examined
<b>COLCHESTER, NY</b>				
	Downs Brook, Ice Jams on East Branch Beaverkill and Spill from Pepacton Dam	Levee, floodwall	.2 to 1	(1) Streambank ecosystem restoration could restore the natural channel thereby improving stream flow capacity  (2) sheet pile levee in Downsville  (3) Channel modification of Downs Brook  (4) High flow diversion
	Hamlet of Cooks Falls-Level of damages precludes significant structural alternatives			(1) Floodproofing, ring levees or grading by homeowners may be warranted
	Hamlet of Horton-Level of damages precludes significant structural alternatives.			(1) Floodproofing, ring levees or grading by homeowners may be warranted
	Hamlet of Shinopple-Level of damages precludes significant structural alternatives			(1) Floodproofing, ring levees or grading by homeowners may be warranted
	Hamlet of Corbett-Level of damages precludes significant structural alternatives.			(1) Floodproofing, ring levees or grading by homeowners may be warranted

Table 3.5  
Solution Matrix for Top 10 Priority Communities (Continued)

Community	Flooding Issues	Solutions Previously Evaluated	Benefit to Cost Ratio from Previous Evaluations	Potential Alternatives to be Re-examined
<b>ROCKLAND, NY</b>				
	Hamlet of Livingston Manor	(1) system of levees, channel relocation and a flume and wall structure (2) levee around Willowemoc Hodel, modify Rock Avenue Bridge, levee, pumping stations	(1) 1.3 to 1 (2) .29 to 1	(1) Restore the Little Beaver Kill  (2) Create wetlands at former borrow pits  (3) Short floodwall along low spot on Pearl Street  (4) Replace existing Main Street bridge to enlarge opening  (5) Realign mouth of Little Beaver kill  (6) Connect ponds at base of mountain as high flow channel  (7) Create flood plain by removing material and lowering ground elevations  (8) Reduce backwater at NYS Route 17 bridge downstream of the sewage treatment plant where it cuts across the floodplain of Willowemoc Creek.



Table 3.5  
Solution Matrix for Top 10 Priority Communities (Continued)

Community	Flooding Issues	Solutions Previously Evaluated	Benefit to Cost Ratio from Previous Evaluations	Potential Alternatives to be Re-examined
<b>ROCKLAND, NY (Continued)</b>				
	Hamlet of Rockland			(1) Evaluate backwater conditions at Junction pool  (2) Flood proofing, ring levees or grading by homeowners may be warranted.
	Hamlet of Roscoe			(1) Evaluate NYS Route 17 embankment as a levee along Wilowemoc Creek  (2) Design lift station/interior drainage plan for Roscoe Central Business District (3) Evaluate backwater conditions at Junction Pool (4) Flood proofing, ring levees or grading by homeowners may be warranted.
	Hamlet of Lewbeach			(1) Floodproofing, ring levees or grading by homeowners may be warranted

\* Reverse 911 and/or floodwarning systems should be considered for all ten priority communities.

Buyouts or raising of structures should be considered for all communities when no structural solutions are deemed feasible.

Environmental restoration projects should be evaluated for all communities, particularly when structural alternatives alone are not sufficient for BCR justification.

### **3.6 FLOOD RISK MANAGEMENT RECOMMENDATIONS**

Below is a summary of potential future efforts which should be evaluated further.

#### **3.6.1 Flood Warning/Forecasting Tool for Entire Delaware River Basin**

Flood Inundation Mapping similar to that being developed for the Delaware River Basin Comprehensive, Watershed Flood Management Plan should be developed for the entire mainstem Delaware to be used as a planning and emergency management tool.

Using the depth grid and underlying base data, determination of extent and depth of flooding as it impacts buildings and transportation systems and expected damages to structures and contents could be made readily available through the GIS. This would not only assist in safe evacuations but also assist in assessment of post event damages

#### **3.6.2 Detailed Flood Risk Management Feasibility Studies for Priority Communities.**

Due to ever changing conditions, such as increased development, changed land use, increased property values, updated stage frequency curves and other detailed studies, these sites should be re-evaluated using the potential recommendations provided in the solution matrix as part of collaborative, multipurpose planning efforts. Communities should prepare flood mitigation plans in coordination with State Emergency Management Agencies.

#### **3.6.3 Detailed Feasibility Studies for Additional Flood Prone Communities.**

Detailed studies should be conducted for the ten priority communities as they have the greatest damages and the most urgent needs. Additional flood prone communities beyond the ten priority communities identified in this report should also be evaluated to address and help mitigate their damages from flooding. This study limited its flood risk management evaluations to only ten communities due to funding constraints. However, results from the repetitive and severe repetitive loss claims, evaluated in this report, show a need for additional detailed studies that go beyond these ten priority communities.

#### 4.0 ESTUARY INFLOW EVALUATION

Salinity, whether caused by sea-water intrusion or by the discharge of wastewaters containing dissolved solids, is a major concern in the Delaware Estuary. The estuary serves as a source of water supply for municipalities and industries, and as a habitat for many fish and wildlife species. Salinity is of concern in the Estuary not only because of the damage and associated costs to the residents, municipalities, and industries in the region but also because of health problems associated with a high-sodium water supply.

Salinity intrusion is such a concern to the local habitat and water supply that the DRBC's drought plans are triggered by the movement of the "salt front". The salt front is defined as 7-day average location of the 250mg/L chloride concentration in the Delaware Estuary. As the salt front moves upriver it increases corrosion control costs for surface water users, particularly industry, and has the potential of raising sodium levels in a large aquifer underlying southern New Jersey which is used for municipal water supply. The tidal Delaware River also provides drinking water for approximately 1.5 million people in the Philadelphia metropolitan area, primarily through surface water intakes on the Delaware River and its tributaries. In recent years, the salt front has migrated into streams and creeks in Delaware, threatening water supplies in northern New Castle County.

Tidal freshwater of Delaware River is maintained by carefully monitoring flows in the non-tidal river and location of the salt front to support drinking water use purposes. During periods of low flow, additional fresh water is released from up basin reservoirs to keep the salt front well below the water intakes in the tidal fresh water portion of the river. Complex operational rules are applied for New York City's Delaware Basin reservoirs for their diversions and releases based on amount of reservoir storage and salt front. These complex reservoir operation rules have been continuously modified to optimize the use of limited water resources. These reservoir operation rules are evaluated through the use of three stand-alone water resources computer models: the Operational Analysis and Simulation of Integrated Systems (OASIS flow model) one-dimensional reservoir operating model, The Dynamic Estuary Model Hydrodynamics Program (DYNHYD5) hydrodynamic model and the TOXI5 chloride transport model (the latter two are collectively referred to as "the estuary salinity model").

Through this study the team linked these models enabling engineers to better evaluate the reservoir operating policies of the effects of reservoir operating program alternatives on salinity concentrations within the estuary and thus enhancing the ability of the DRBC staff to furnish the commissioners with the technical support they require to make informed flow management policy decisions; and in particular to provide the Commission with the support that it has recently requested for the development of flood mitigation operating plans for existing reservoirs as modifications to operations of reservoirs. Therefore, the tool developed as part of this effort will enable DRBC and other basin stakeholders to better incorporate the effect any proposed changes in the basin would have on salinity or the location of the salt front. This is a valuable investment for the future of the Basin.

Appendix C provides more detail on the development of these model linkages.

## **5.0 RE-EVALUATE APPROACH TO USER SUPPLY COSTS TO SUPPORT FLOW MANAGEMENT AND EQUITABLE ALLOCATION GOALS**

**5.1 Financing Water Supply Storage.** While the DRBC does not own or operate any of the dams within the Basin, it has purchased a portion of the storage in two Corps of Engineers' reservoirs, Blue Marsh and Beltzville. Storage consists of 9.2 billion gallons in Beltzville and 2.6 billion gallons in Blue Marsh Reservoir. This storage is financed through a surface water charging program established in 1971.

By Resolution No. 64-16A in 1964, the Commission authorized a water charging program. It provided for the revenues generated by the program to be used for repayment of the nonfederal share of the investment cost of water supply storage facilities associated with federal projects within the Basin. In anticipation of Commission investment in storage at the Beltzville Lake and Blue Marsh Reservoir projects in Pennsylvania, the Commission by Resolution No. 1971-4 defined, among other things, the means by which it would establish water charging rates.

These rates have not changed since their inception. However, due to ever changing demands in water supply and the potential need for additional storage, this study took the opportunity to review projected costs for water supply and alternate rate calculation methods in order to meet these costs.

**5.2 Determining Water Supply Costs through 2030.** In order to determine funds needed by DRBC to meet costs through the year 2030, cost data was developed for the following:

- Estimated annual operation, maintenance, and administrative costs
- Estimated major repair/upgrades costs
- Current replacement costs for both dams and facilities
- Projected costs to meet increased demand

The costs for the above, with the exception of the current replacement costs, were projected to fiscal year 2030. The DRBC cost share for each project is 31.01% for Beltzville Lake and 12.698% for Blue Marsh Lake.

**5.2.1 Estimated Annual Operation, Maintenance and Administrative Costs.** The estimated joint use annual operation, maintenance, and administrative cost were projected from the actual costs of \$207,150 for Beltzville Lake billed in fiscal year 2006 and \$64,995 for Blue Marsh Lake billed in Fiscal Year 2007. The costs used are representative of the joint use general operation and maintenance costs for each project. The costs were then escalated from their respective fiscal years to Fiscal Year 2030 by compounding the costs based on a 3.18% per annum rate of inflation. The rate of inflation is based on an annualized rate of inflation calculated from the Construction Cost

Index for last 10 years from July 1996 to July 2006 as published by Engineering News-Record. It is assumed that the inflation trend for the last 10 years will continue into the future. The projected joint use costs are presented in Table 5.1. It is anticipated that there will not be a major increase in these general operations and maintenance costs, however there is no guarantee of future budget levels or required costs.

Table 5.1  
Estimated Annual Operation and Maintenance  
Joint Use Costs

FY	Beltzville Lake			Blue Marsh Lake		
	O&M	O&M	Total	Projected	O&M	Total
	Projected	Actual				
2006		<b>\$207,150</b>	<b>\$207,150</b>			
2007	\$213,737	N/A			<b>\$64,995</b>	<b>\$64,995</b>
2008	\$220,534	N/A	\$220,534	\$67,062	N/A	\$67,062
2009	\$227,547	N/A	\$227,547	\$69,194	N/A	\$69,194
2010	\$234,783	N/A	\$234,783	\$71,395	N/A	\$71,395
2011	\$242,249	N/A	\$242,249	\$73,665	N/A	\$73,665
2012	\$249,953	N/A	\$249,953	\$76,008	N/A	\$76,008
2013	\$257,901	N/A	\$257,901	\$78,425	N/A	\$78,425
2014	\$266,103	N/A	\$266,103	\$80,919	N/A	\$80,919
2015	\$274,565	N/A	\$274,565	\$83,492	N/A	\$83,492
2016	\$283,296	N/A	\$283,296	\$86,147	N/A	\$86,147
2017	\$292,305	N/A	\$292,305	\$88,886	N/A	\$88,886
2018	\$301,600	N/A	\$301,600	\$91,713	N/A	\$91,713
2019	\$311,191	N/A	\$311,191	\$94,629	N/A	\$94,629
2020	\$321,087	N/A	\$321,087	\$97,639	N/A	\$97,639
2021	\$331,297	N/A	\$331,297	\$100,744	N/A	\$100,744
2022	\$341,832	N/A	\$341,832	\$103,947	N/A	\$103,947
2023	\$352,703	N/A	\$352,703	\$107,253	N/A	\$107,253
2024	\$363,919	N/A	\$363,919	\$110,663	N/A	\$110,663
2025	\$375,491	N/A	\$375,491	\$114,182	N/A	\$114,182
2026	\$387,432	N/A	\$387,432	\$117,813	N/A	\$117,813
2027	\$399,752	N/A	\$399,752	\$121,560	N/A	\$121,560
2028	\$412,464	N/A	\$412,464	\$125,426	N/A	\$125,426
2029	\$425,581	N/A	\$425,581	\$129,414	N/A	\$129,414
2030	\$439,114	N/A	\$439,114	\$133,529	N/A	\$133,529
	* Annualized rate of construction cost inflation for last 10 years applied:					
	3.18% per annum rate of inflation					
	Source: Engineering News-Record's Construction Cost Index					

**5.2.2 Estimated Major Repair/Upgrade Costs.** The estimated costs for major repair/upgrades at both Beltzville and Blue Marsh Lakes were developed from a list of backlog maintenance items and utilizing engineering judgment in order to predict the need for certain components or systems to have a major repair or upgrade. The estimated costs for each item were developed based on either past experience or engineering estimates. These costs are subject to change based on factors such as long term inflation rates and the competitive market.

These cost were then escalated from fiscal year 2007 to the appropriate fiscal year based on a compounded escalation factor of 3.18%, which was based on a per annum rate of inflation as detailed in the above paragraph. The cost to DRBC was then calculated based on the cost share percentage for the respective project. The estimated major repairs/upgrades for Beltzville and Blue Marsh Lakes are presented in Tables 5.2 and 5.3 respectively. It should be noted that the items presented are based on a prediction of service life and repair history and is subject to change. Items budgeted for certain fiscal years may be deferred or expedited based on budget constraints or the immediate need for repair or upgrade.

**Table 5.2  
Beltzville Lake**

<b>Estimated Major Repairs/Upgrades</b>					
<b>FY</b>	<b>Description</b>	<b>FY07 Est. Cost</b>	<b>Escalate to FY Cost</b>	<b>Cost Share %</b>	<b>DRBC Est. Cost</b>
2008	Lead Paint Remediation (Tower)	\$180,000	\$185,724	31.01%	\$57,593
2008	Replace Operations Building HVAC	\$30,000	\$30,954	31.01%	\$9,599
2008	Upgrade Water Control Platform	\$22,000	\$22,700	31.01%	\$7,039
2008	Replace Standby Generator	\$50,000	\$51,590	31.01%	\$15,998
2008	Repair Outlet Structure/Conduit	\$655,000	\$675,829	31.01%	\$209,575
2009	Upgrade Operation Building Potable Water System	\$25,000	\$26,615	31.01%	\$8,253
2009	New Dehumidification System	\$38,000	\$40,455	31.01%	\$12,545
2010	Positional Survey: Dams & Structures	\$52,000	\$57,120	31.01%	\$17,713
2010	Elevator Upgrade	\$500,000	\$549,233	31.01%	\$170,317
2010	Replace Sump Pit 4" Backwater Valve	\$50,000	\$54,923	31.01%	\$17,032
2010	Repair Emergency Spillway Chute	\$473,000	\$519,574	31.01%	\$161,120
2010	Rehabilitate Flood Control Gate	\$1,000,000	\$1,098,466	31.01%	\$340,634
2010	Replace gear box & limit torque motor on water quality gate	\$50,000	\$54,923	31.01%	\$17,032
2011	A-E Study on Tower Concrete	\$80,000	\$90,672	31.01%	\$28,117
2011	Paint Tower Spillway Bridge	\$544,000	\$616,568	31.01%	\$191,198
2012	Plug/Grout Piezometer/H2O Sampling Piping Terminals	\$341,000	\$398,779	31.01%	\$123,661
2012	Electrical upgrade @ elevations 548, 530 & 519	\$50,000	\$58,472	31.01%	\$18,132
2013	Discharge Channel-Right Bank Stabilization	\$595,000	\$717,943	31.01%	\$222,634
2013	Replace Hydraulic fluid tank, pumps (2), motors (2)	\$250,000	\$301,657	31.01%	\$93,544
2013	Upgrade Sump Pumps (2)	\$50,000	\$60,331	31.01%	\$18,709
2014	Automated Geotechnical Data Acquisition System	\$215,000	\$267,675	31.01%	\$83,006
2014	Install AAR Remedial Lining @ Intake Tower	\$1,500,000	\$1,867,497	31.01%	\$579,111
2015	Tower Mechanical Repairs (Intake/Exhaust Fans/Heater)	\$40,000	\$51,384	31.01%	\$15,934
2015	Positional Survey: Dams & Structures (every 5 yrs)	\$52,000	\$66,799	31.01%	\$20,714
2020	Positional Survey: Dams & Structures (every 5 yrs)	\$52,000	\$78,117	31.01%	\$24,224
2025	Positional Survey: Dams & Structures (every 5 yrs)	\$52,000	\$91,353	31.01%	\$28,329
2030	Positional Survey: Dams & Structures (every 5 yrs)	\$52,000	\$106,832	31.01%	\$33,129

Table 5.3  
Blue Marsh Lake

Estimated Major Repairs/Upgrades					
FY	Description	FY07	Esc.	Cost	DRBC
		Est. Cost	to FY Cost	Share %	Est. Cost
2008	Repair Hydraulic Seals on Service Gates	\$55,000	\$56,749	12.698%	\$7,206
2008	Upgrade Water Control Data Platform	\$22,000	\$22,700	12.698%	\$2,882
2010	Positional Survey: Dams & Structures (every 5 yrs)	\$52,000	\$57,120	12.698%	\$7,253
2010	Evaluate Reservoir Bank Erosion	\$58,000	\$63,711	12.698%	\$8,090
2010	Upgrade Operations Building Potable Water System	\$25,000	\$27,462	12.698%	\$3,487
2011	Rehabilitate Flood Control Gate	\$291,000	\$329,819	12.698%	\$41,880
2011	Replace Leaf Gate on Service Gate #1 Motor	\$300,000	\$340,019	12.698%	\$43,176
2012	Concrete Repairs in Stilling Basin	\$230,000	\$268,971	12.698%	\$34,154
2013	Lead Paint Remediation - Service Bridge	\$290,000	\$349,922	12.698%	\$44,433
2013	Replace Operations Building HVAC	\$30,000	\$36,199	12.698%	\$4,597
2014	Automated Geotechnical Data Acquisition System	\$244,000	\$303,780	12.698%	\$38,574
2014	Rehab Water Quality Gate	\$600,000	\$746,999	12.698%	\$94,854
2015	Positional Survey: Dams & Structures (every 5 yrs)	\$52,000	\$66,799	12.698%	\$8,482
2016	Replace Operations Building Roof	\$50,000	\$66,272	12.698%	\$8,415
2016	Rehabilitate Flood Control Gate	\$1,000,000	\$1,325,439	12.698%	\$168,304
2020	Replace Tower Heater	\$20,000	\$30,045	12.698%	\$3,815
2020	Positional Survey: Dams & Structures (every 5 yrs)	\$52,000	\$68,923	12.698%	\$8,752
2020	Water Quality Control Selective Withdraw System	\$1,500,000	\$2,253,373	12.698%	\$286,133
2025	Positional Survey: Dams & Structures (every 5 yrs)	\$52,000	\$91,353	12.698%	\$11,600
2030	Positional Survey: Dams & Structures (every 5 yrs)	\$52,000	\$106,832	12.698%	\$13,565
<b>Bernville Protective Works</b>					
2011	Upgrade Pumping Station Float Switch System	\$50,000	\$56,670	12.698%	\$7,196
2012	Replace Roof on Pumping Station	\$30,000	\$35,083	12.698%	\$4,455
2015	Upgrade Pumping Station Control System	\$600,000	\$770,753	12.698%	\$97,870
2025	Rehabilitate Pumping Station Pumps	\$1,500,000	\$2,635,182	12.698%	\$334,615

**5.2.3 Projected Costs to Meet Increased Demand.** Based on the results of this study there are no non-power sector water supply deficiencies in the Schuylkill River Basin by the year 2030 when using the Q<sub>7</sub>10 flows for 2030. However, if the potential power demands on the Schuylkill River were not met by power transmission from out of the basin, the water deficiency for this sector would be 518 mgd by the year 2030.

For sensitivity analyses, the team also investigated the impact of reducing the Schuylkill Q<sub>7</sub>10 flow by 50 percent. As a result of this decrease, the water deficiency increased to 139 mgd not including the power sector demands.

Under this scenario, the construction of three new reservoirs in the Schuylkill basin could make up the 139 mgd non-power deficiency. However, the potential power sector



deficiency of 518 mgd could not be met with these reservoirs. The total project cost of constructing three new reservoirs, Maiden Creek, French Creek and Evansburg, was estimated to be 746 million dollars. If flood damage reduction were one of the authorized uses in addition to water supply, the water supply related costs would be less. The costs for these three reservoirs were escalated from the 1959 Section 522 study up to 2008.

The cost of providing the additional water supply depends on which one or all of the suggested projects would be built. To illustrate the significance of the financing endeavor to construct one of the reservoirs, it is useful to consider financing a hypothetical 300 million dollar reservoir as well as some of the policy considerations that the DRBC would have to evaluate in order to fund the project through its water charging program.

The example reservoir would be similar in cost to the 1986 proposed water supply modification of F.E. Walter Reservoir, located on the upper Lehigh River, and would portray the difficulty in funding large, expensive water supply projects by the DRBC. The DRBC proposed to modify F.E. Walter Reservoir to supply 23 billion gallons (bg). The estimated water supply related cost at that time was about 160 million dollars. This cost today adjusted for inflation would be 100 percent higher or approximately 320 million dollars. This amount of money would probably only be sufficient to build one of the three new reservoirs being considered to meet the 139 mgd non-power sector water deficiency, assuming that the DRBC would have to fund the entire project without any federal support.

Currently, the DRBC's charging system brings in revenue of about 2.7 million dollars annually to pay for the water supply portion of Blue Marsh and Beltzville Reservoirs. This revenue covers the debt service, operation and maintenance and administrative costs. The water supply portion of these two reservoirs cost about 15 million dollars when they were built.

The methodology that the DRBC used to determine the current water charging rates is based on the calculated safe yield of the two water supply reservoirs, namely Blue Marsh and Beltzville. The safe yields of these two reservoirs were 30.8 mgd and 28.7 mgd, respectively, using the 1960's drought as the record drought. In 1978 the DRBC last increased the consumptive surface water charging rate to \$60 from \$40 per million gallons to include the cost of Blue Marsh Reservoir. The safe yield of the modified F.E. Walter Reservoir is approximated by dividing 23 bg storage by 122 days, the time duration between June and September. This results in a safe yield of 188 mgd.

To illustrate the significantly large increase in funding needed to fund a large reservoir project, one of the suggested reservoirs would most likely cost 300 million dollars. To borrow this amount for 30 years at an interest rate of 5 percent tax exempt bonds the debt repayment would be 19.33 million dollars annually exclusive of operation and maintenance. Using the pooled water concept which combines the safe yield of the hypothetical reservoir and of Blue Marsh and Beltzville, the revised consumptive use water rate would be \$226.7 per mg compared to the current consumptive use water rate of

\$60 per mg., an increase of 3.78 times. Factoring in this increase to the current revenue of 2.7 million dollars, the annual revenue would increase to 10.2 million dollars. This is approximately 10 million dollars less than what would be required to pay the revised annual repayment. This would indicate that the methodology of calculating water rates would have to be modified if an additional reservoir were built.

The proposed modification of F.E. Walter Reservoir in 1986 indicated the potential problems that would ensue should the DRBC fund such a project. The DRBC realized that the use of its existing water charging program to fund 160 million dollars would have significantly increased the cost burden of the then approximately 200 post-Compact (1961) surface water users. In order to spread the impact of this rate increase, the DRBC proposed changing its policy of exempting from charge pre-Compact and ground water users. This would have distributed the costs among many more users. The proposed new policy and resulting charging schedule was met with great opposition from many pre-compact large water users that held water entitlements and from farmers that primarily used ground water for irrigation. The proposed F.E. Walter modification did not proceed because of the basin community's opposition to the increased water charges and the lack of Congressional support to change the DRBC Compact to charge pre-Compact water users.

Changes in federal government funding policies have put the burden of funding reservoir projects directly on the sponsor compared to the 1970s and 1980's when Federal financing of up to 70 percent of the project cost was available.

The problems associated with funding larger amounts of capital would again arise if another large reservoir project was proposed. Fundamental policies of charging the basin water users would have to be examined once more by the DRBC. Also, if a proposed reservoir's water supply benefit a specific area such as the Schuylkill basin, the question of which users to charge would need to be answered.

If additional water supply is needed to supply future in-basin power generating facilities, as shown previously, there is not enough existing water supply storage in the basin to compensate for this added demand. Instead of building additional storage capacity it is possible to have the utilities allocate the remaining storage of approximately eight billion gallons in the Merrill Creek Reservoir. This storage, under present DRBC regulations, is released to make up the utilities' generating facilities consumptive use only when the basin is in drought warning or drought conditions. However, these releases would not add to the Q<sub>7</sub>10 minimum flows of the stream or river.

**5.3 Debt Repayment.** As part of the investigation regarding the setting of DRBC water user charges, the DRBC requested the Corps to provide estimates until the year 2030 of the cost of future capital replacement and operation and maintenance costs for Blue Marsh and Beltzville Reservoirs. The DRBC owns water supply storage in these two reservoirs and is responsible for paying the Federal Government a portion of future capital replacement costs as well as operation and maintenance costs. The percentage of cost obligation depends on whether or not they are water supply related or joint

replacement costs. The DRBC's portion of joint costs for Blue Marsh and Beltzville Reservoirs are 12 percent and 31 percent, respectively.

The estimated costs for both reservoirs from 2008 to 2030 are displayed in Tables 5.2 and 5.3. Also included in these tables are costs for principal and interest, depreciation, in accordance with the type of accounting the Commission utilizes for the reservoirs. The total costs over the 23 years to 2030 total \$40.236 million dollars, not including DRBC administrative expenditures. The current indebtedness for Beltzville is scheduled to be paid by 2021 and that for Blue Marsh by 2030. As those debts are retired, there would be a basis for reducing water charging rates.

DRBC estimated revenues and expenditures for the same time period up to 2030. This includes water supply related salaries and fringe benefits, administrative and special project costs, transfers to the general fund, water sales revenue, and investment income. The revenue stream from surface water charges was assumed to increase at a rate one percent annually. This resulted in estimated total revenues of \$90.140 million dollars compared to estimated total cost of 80.216 million dollars. This would result in a \$9.923 million dollars surplus by 2030. The funding of any capital replacements would have to be authorized by Congress prior to their construction by the Corps.

**5.4 Alternative Charge Schedules.** While capital and repair and replacement costs were updated, the team reviewed alternative charge schedules that could be used to help meet potential increased needs. Technical Appendix D provides an overview of the 1987 Black and Veatch Report to be used as a reference for researching and developing alternative charge schedules.

**5.5 Determining Need to Update Surface Water Rates for Basin Users.** At this time it does not appear necessary to update surface water rates to basin users based on the information gathered in this report. However, additional water supply needs should be re-evaluated under a thorough drought analysis.

## **6.0 PUBLIC ACCESS TO INFORMATION**

The Public Access component of this study requires that all data gathered for this study be made available to anyone wishing to use it. This information will be placed on an internet site and will include water supply/flood damages/demographics/ revised stage-frequency curves/results of skew analysis and other such data so agencies can use similar methodology for conducting studies within the Basin.

## **7.0 CONTINUATION OF EFFORTS**

Whereas most USACE reports end with final recommendations regarding possible future construction opportunities, this study is much different. The focus of this study was to use limited Federal funds in order to bring together key stakeholders from all levels of government and interest groups to form cooperative partnerships in order to more effectively identify and address water resources needs in the region. Through this study the Corps has worked with several important entities contributing to the Strategic Vision of the Delaware River Basin. Partnerships are growing stronger through stakeholder involvement and Federal agency collaboration, the river is being viewed by many more agencies as a comprehensive unit with inter-related needs and solutions, and future projects and initiatives are encompassing these ideals. It is important to recognize that even with a long-term plan and good intentions, it is imperative that USACE and their partners have adequate funding, resources, and staff to implement the Strategic Vision.

Through continued involvement and leadership, USACE can support the Strategic Vision and priorities and serve as a lead facilitator to recast the importance of a comprehensive and holistic approach to achieve long-term and sustainable environmental, economic, human, and social benefits. Furthermore, through collaborative and creative formulation of programs and projects that support the Vision, USACE should be better positioned to garner Federal funding to address watershed-based priorities that are broadly endorsed by the collective interests of many partners within the Delaware River Basin.

Over the years, many agencies' water resources projects and programs have contributed to meeting the needs of the people and resources of the Delaware River Basin. Examples include the construction and maintenance of reservoirs and/or flood damage reduction projects (USACE and local projects), DRBC regulation of consumptive water use and mitigation, construction of acid mine drainage abatement and abandoned mine land reclamation projects, water quality gauging and monitoring, planning and construction of environmental restoration projects, and implementing migratory fish passages.

Coordination and collaboration are routine through the regular DRBC meetings, the Water Quality Advisory Committee (WQAC), Flood Advisory Committee (FAC) and the many other DRBC sub-committees. The USACE will continue participating in the many ad-hoc advisory groups which are formed when specific issues arise and will actively participate in the preparation of technical documents addressing these issues, such as the Flood Mitigation Task Force Report, Flexible Flow Management Plan, and others.

It is important that USACE continues this effort by seeking opportunities for multi-party collaboration involving Federal, regional, state, local, and non-governmental organizations (NGOs). Potential collaboration within the Delaware River Basin could include: Ducks Unlimited, Trout Unlimited, The Nature Conservancy, Eastern and Western Pennsylvania Coalitions for Abandoned Mine Reclamation, Wildlands Conservancy, Pennsylvania Organization for Watersheds and Rivers, and many others.

There are many ongoing activities and successful efforts in the Delaware River Basin. Many needs and opportunities exist, and new ones will be identified. However, with a common vision, consistent and open dialogue, and adequate resources, the positive impacts from individual and collective activities and coordination will continue to sustain the Delaware River as a valuable natural resource in the region and nation.