

Table of Contents

PRICES ARE PER 100 TARGETS.

PAGE 2

	Page		Page
Table of Contents	2	Range Accessories	33 – 37
Discounts / Terms / Conditions	3	Optics / Shooting Glasses	33
Introduction	4	Optics / Binoculars / Spotting Scopes	34
Range Systems	5	Hearing Protection	35
Tactical Ted	5	Timers / Chronographs	36
Law Enforcement Targets	9 – 22	Gun Care	37
600 Series Realistic Color Targets with Overlays	6-7	NRA IBS Targets	38 – 48
Professional Combat Training Targets	9	NRA Pistol Targets / Action Pistol Targets	38 – 39
Colored Police Silhouette Training Targets	10 – 11	NRA Training & Qualification Targets	40 – 41
Police Qualification & Combat Targets	12 – 13	NRA Small Bore Rifle Targets	42 – 43
Federal Enforcement Training Targets	14 – 15	NRA High Power Rifle Targets / IBS Targets	44 – 45
State & Municipal Police / Countersniper Targets	16 – 17	High Power Rifle Spotters / Spindles /	
500 Realistic Situation Police /		Value Indicators / Group Markers / Pastors	46
Countersniper Targets	18 – 20	NRA Air Rifle Targets	47
Police Indoor Range Targets	21	Military DOD Targets	48
Backers / Silhouette Bobbers / Facers / Pastors	22	Sighting Targets	49 – 53
IPSC / IDPA Targets	22	Archery Targets	53
Steel Range Products	23 – 29	Games of Chance – Fun Targets	54
Reactive Steel Targets	24 – 25	Bullseye Gallery Targets	55
Speed Plates / Duelling Trees /		Reactive “Sealite” Plastic Targets	56
Challenge Plates / Stands	26	Long Gun Data Books / Shotlog Data Systems	57
Steel Reactive Targets	27	Muzzle Loading Targets	55
Steel Plates	28 – 29	Order Form	58
Range Equipment	30 – 32	Notes	59
Ultraclean	30 – 31	Sample Packs	Back Cover
Slugmaster	8		



Discounts / Terms & Conditions

PRICES ARE PER 100 TARGETS.

PREFERRED DISTRIBUTORS

The following Discounts, Terms, and Conditions are authorized for approved Preferred Distributors only.

DISCOUNTS

Combined List Value over \$500	50%	• Steel Range Products	20%
Combined List Value over \$250	50%	• Reactive "Sealite™" Plastic Targets	
Combined List Value under \$100	40%	• 3-D "Tactical Ted" Realistic – Situation Targets	20%
• Paper Targets	• Cardboard Targets	• IPSC-CB Targets	• IDPA-CB
• Bobbers	• Pastors	• BP-CB Targets	• D-1 CB Targets
• Facers	• Spotters	• STS-1 Shotlog Target System (SWAT)	• Data Books
• Spindles			
Cardboard Backers	List	• Pro-Timers	• Range Caps
• IBS Targets	• Muzzle Loading Targets	• Chronographs	
		• Range Systems	• "Ultra Clean™"
• Shooting Glasses		• Slugmaster	
• Binoculars	• Spotting Scopes		10%
• Hearing Protection	• Gun Care Products		

ORDERING

- Use designated **Speedwell™** or **NRA** Target or Product number and/or description. Order target quantities in standard carton lots to expedite delivery. There is a small up-charge for re-packaging less than standard carton lots.
- Custom targets printing, packaging, and private labeling are available upon request.
- Custom manufactured steel products and range equipment are available for special customer requirements.
- Professional design, engineering, and technical assistance is available at no cost.

TERMS

Net 30 Days for approved accounts. Check money order, VISA, Mastercard or AMEX are accepted. Add New Jersey Sales Tax (7%) where applicable

FOB

Union, New Jersey, unless otherwise specified. Inquires will be quoted FOB – Destination Upon Request.

PRODUCT WARRANTY

Speedwell™ Products are unconditionally guaranteed against defective materials or workmanship for ONE YEAR. They will be replaced or repaired at no cost.

MANUFACTURING STANDARDS

Speedwell™ Targets and Range Equipment are produced in a state-of-the-art plant utilizing the highest manufacturing and quality assurance technology. **Speedwell™** Paper targets are manufactured from 40% recycled stock, consisting of 25% pre-consumer, 15% post consumer content. All target paper is chlorine free.

The exclusive use of high grade NRA target paper guarantees compliance with stringent National Rifle Association Specifications. Each finished target must comply with precise dimensions, clear-cut, unbroken scoring lines, with no fill-in or feather edges on scoring lines. NRA grade paper stock assures clean bullet holes with adequate toughness to withstand reasonable handling, wind, and rain.

Speedwell™ Steel targets are manufactured from select ballistic grade stock with guaranteed minimum Brinell hardness for each grade. Refer to page 25 for additional information on Steel Products.

Military Target Paper

Specifications: Primary Military Specifications for Type I and Type II Target Paper

	Type I	Type II
Basic Weight 24 x 36	60# ± 3#	120# ± 6#
Caliper	.054 to .060	.106 to .114
Wax Pick	Min. 9 Avg. 11	Min. 9 Avg. 11
Mullen (Min.)	30	40

NRA Target Tag

Weight:	24 x 36 — 100/500
Furnish	25%–30% Sulphite 75%–70% Groundwood
Caliper	0.10, plus or minus .005
Mullen	Average 35 points
Tear	Average 54 grams
Brightness	Not to exceed 80 ASA

NRA Target Paper

Weight:	24 x 36 — 44/500
Furnish	20%–25% Sulphite 80%–75% Groundwood
Caliper	0.65, plus or minus .0025
Mullen	Average 14 points
Tear	Average 32 grams
Brightness	Not to exceed 80 ASA

Target Ink

Specifications:	Non-glare / WOS Black Ink
Tack (Stability)	5.5 @ 1200 rpm
Laray Viscometer	Shortness ratio 42 / Yield volume 1210
Water Pick	35-55
Fitness grind	0 / 0



Being the major manufacturer and supplier of paper, cardboard and steel targets for the NRA, law enforcement and civilian shooting markets, we pride ourselves on producing very high quality products in a state-of-the-art manufacturing facility.

Complimenting our traditional line of targets, we have added new unique targets and range products carefully selected for their high quality.

They include:

- New 600 Series Color Realistic/Situation Targets™ (page 6-7)
- New Reactive Steel Targets (page 28-29)
- Long Gun Data Books (page 63)
- Ultra Clean™ Weapons Cleaning Systems (page 30-32)
- Slugmaster Unloading System (page 8)
- Shotlog Data Card System (page 63)

It is our commitment to provide both the law enforcement and civilian shooting markets with the finest products available at reasonable prices.

You may buy cheaper, but you will never buy better quality. We are competitive with equal quality products.

Because of their popularity and your requests for new **REALISTIC/SITUATION™** targets, we have added 8 new color targets with overlays to our ever popular 600 series combat target line.

Self setting steel targets reduce down time on the range to reset targets after each shooter. We continue to maintain the largest inventory of steel targets in 3 grades of steel. Unlike some competitors we do not make steel targets that "can be turned around when they are warped or damaged" as this is very dangerous.

"A clean weapon may save your life – A dirty one might not." "Ultra Clean"™ Weapons Systems are the safest and most efficient means available to maintain clean serviceable firearms.

Every Police department, law enforcement agency, and range should have a **Slugmaster Unloading Station** to insure the safe handling of weapons.

There has always been a demand for a practical **Comprehensive Long Gun Data System**. Developed by Christopher Rogers, we have added this product to our catalog. It is an amazing method of maintaining a realistic log system for tactical and swat teams.

The **Shot Log System** also developed by Rogers provides data for long gun training and essential records.

Without question, our products are unconditionally guaranteed against defective materials or workmanship for ONE YEAR. They will be replaced or repaired at no cost to you.

If you are looking for reliable products for the range, please give us a call at 1-800-243-8274. We will strive to give you the best service at the best prices. Special delivered prices at available for target quantities over \$1,000.00.

Visit our web site at www.speedwelltargets.com

Sincerely,

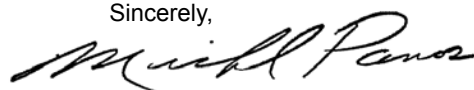

Michael J. Panos
President



REALISTIC-SITUATION™ 3-D HUMAN TARGET

- Precise Life Size Human
- Super Tough Molded Polymer
- Withstands Thousands of Hits
- No Patching Holes
- Anatomically Correct
- Shoot From Any Angle
- Insert Paper Target For Scoring
- Can Be Dressed In Clothing – Shirt, Cap, Wig
- Lightweight
- Targets Stack For Easy Storage
- Will Mount On Turning / Pop-up Target Actuators
- Average Measurements For Ranging Through Sniper Scopes

TED	3-D Human Target Includes: 6 Special FBI Q Scoring Targets – 4 lbs	\$ 39.95
TED-Q	25 Special 2 pc. FBI Q Scoring Targets for Tactical Ted – 6 lbs.	29.95
STA-TED	Portable Static Tactical Ted Target Stand – 17 lbs.	89.00

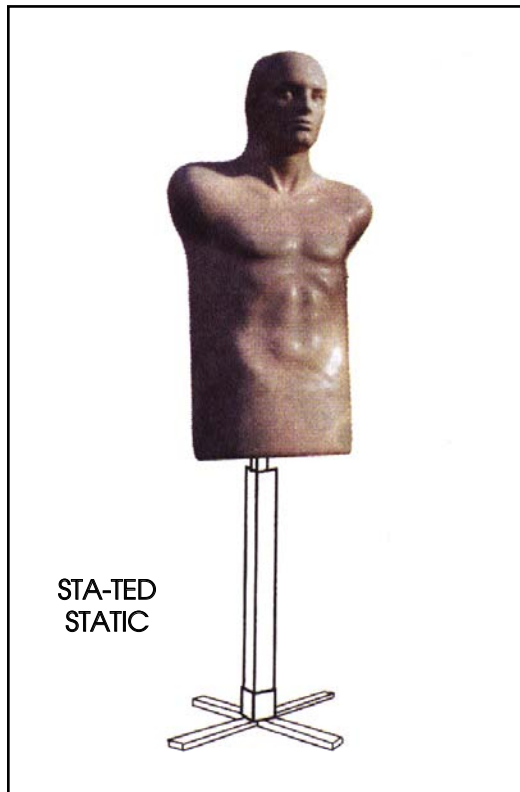

600 Series Realistic-Situation Color Targets with Overlays

PRICES ARE PER 100 TARGETS.

PAGE 6

A series of "REALISTIC-SITUATION" COLOR Targets designed to provide a higher level of self defense skills during an actual lethal encounter, the New "REALISTIC-SITUATION 600" Series Targets are "dual tone" life-sized photographic targets.

Particularly adaptable for use with SPEEDWELL™ Reactive Range equipment, "600 Series" targets provide progressive Firearms Instructors with advanced training tools.

Target overlays presenting various degrees of threat, passive non-threat, or possible mistaken identity can be employed with the "600 Series" Targets.

TARGET NUMBER	DESCRIPTION	SIZE' / STOCK	TARGETS PER CARTON	SHIPPING WEIGHT PER CARTON	LIST PRICE PER 100
601	Hostile Man with Handgun	22 1/2 x 35 P	100	11	\$77.00
602	Hostile Man with Handgun	22 1/2 x 35 P	100	11	77.00
603	Hostile Man with Handgun	22 1/2 x 35 P	100	11	77.00
604	Hostile Man Behind Wall	22 1/2 x 35 P	100	11	77.00
605	Friendly Man with Gun & Badge	22 1/2 x 35 P	100	11	77.00
606	Friendly Man with Caulking Tool	22 1/2 x 35 P	100	11	77.00
607	Man with Baseball Bat	22 1/2 x 35 P	100	11	77.00
608	Hostile Man with Gun	22 1/2 x 35 P	100	11	77.00
609	Hostile Man with Gun	22 1/2 x 35 P	100	11	77.00
650	Target Overlays	VARIOUS P	28	2	31.75

Note "1": P = Paper / 11 = Non NRA Targets

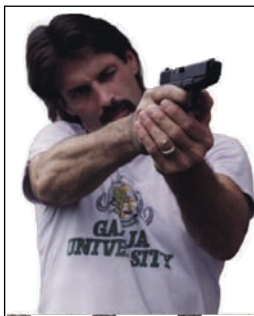

601



602

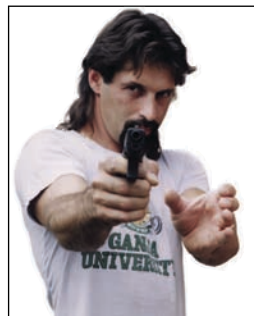

603

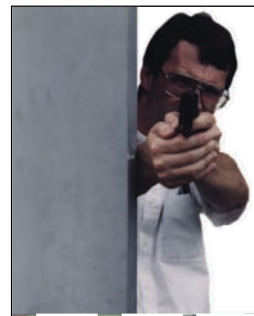

604

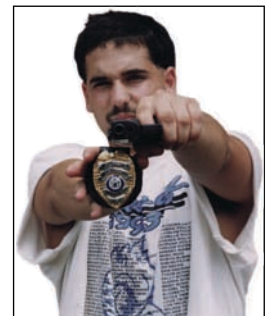

605



606

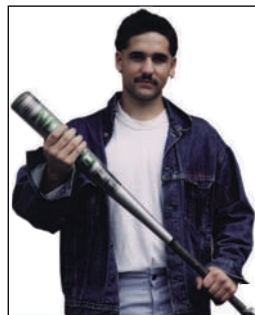

607



608



609



650



1.800.243.8274 □ IN NJ 908.355.8600 □ FAX 908.355.1414

600 Series Realistic-Situation Color Targets with Overlays

PRICES ARE PER 100 TARGETS.

PAGE 7

TARGET NUMBER	DESCRIPTION	SIZE' / STOCK	SHIPPING TARGETS PER CARTON	LIST WEIGHT PER CARTON	PRICE PER 100
611	Hostile Man with Knife and Gun	22 ¹ / ₂ x 35 P	100	11	\$77.00
612	Hostile Man with Machine Gun	22 ¹ / ₂ x 35 P	100	11	77.00
613	Friendly Man with Gun & Badge	22 ¹ / ₂ x 35 P	100	11	77.00
614	Hostile Man with Female Hostage	22 ¹ / ₂ x 35 P	100	11	77.00
615	Hostile Man with Female Hostage	22 ¹ / ₂ x 35 P	100	11	77.00
616	Hostile Man with Female Officer	22 ¹ / ₂ x 35 P	100	11	77.00
617	Hostile Man with Female Hostage	22 ¹ / ₂ x 35 P	100	11	77.00

Note *1": P = Paper / 11 = Non NRA Targets



611

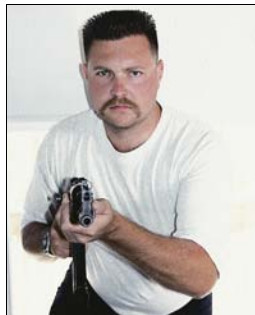

612



613



614



615



616



617



650

\$131⁰⁰

SP-6200

200 Assorted Series 600 "Color" Realistic-Situation™ Targets & Overlays
(List Value \$145.00) Shipping Weight 22 Lbs.

\$317⁰⁰

SP-6500

500 Assorted Series 600 "Color" Realistic-Situation™ Targets & Overlays
(List Value \$362.50) Shipping Weight 55 Lbs.

1.800.243.8274 □ IN NJ 908.355.8600 □ FAX 908.355.1414



“THE ULTIMATE FIREARMS SAFETY DEVICE”



Semi-automatics are quickly becoming standard issue and the SLUGMASTER UNLOADING STATION* can go a long way toward eliminating the risk of accidental discharge.

Every Law Enforcement agency and Police station should have a SLUGMASTER Unloading Station to insure the safe handling of weapons in a critical environment.

Unintentional firearm discharge is a danger you can do without. The SLUGMASTER Unloading Station is the choice of both professional and recreational associations. This stationary piece of safety equipment protects law enforcement and public alike. It uses NO sand or water and takes up little space.

- Bullet loses energy on impact with curved plate
- Chamber contains gases and fragments caused by discharged ammo
- Removable cartridge catcher
- Tensile strength: 190,000 psi
- Heat-treated steel plate, Unobstructive in high traffic areas
- Stops all caliber handguns, rifles and shotguns including .223, .308, .30-06 and .338 caliber ammunition
- Dimensions: 40 x 15 x 15"

Perfect for whatever firearms are stored or retrieved – throughout the station, investigative offices, cell blocks, booking facilities, ranges, etc.

Ease your concerns regarding firearm safety and liability.

The angle and position of the muzzle cone will not allow any ricocheting or fragments from exiting the mouth of the Unloading Station.

SLUGMASTER is only 15" in diameter and will not impede personnel traffic in corridors or within locker rooms. Its overall vertical length is only 40" making it portable and easy to locate.

SLUGMASTER is power coated with baked Safety Red polyester which provides excellent UV protection, impact resistant and visible appearance suitable for Police Station decor.

SLUGMASTER Unloading Station will serve its intended use to protect from an unintentional discharge in the course of unloading or loading of firearms only. The manufacturer warrants the workmanship and structural integrity of the SLUGMASTER as set forth in the instruction Sheet for a period of 20 years.



ITEM NUMBER	DESCRIPTION	SHIPPING WEIGHT PER CARTON	LIST PRICE
SLUG	Slugmaster Unloading Station	130 lbs.	\$1080.00
SLUG TC	Slugmaster Unloading Station Armor Piercing	130 lbs.	\$1180.00
SLUG JR.	Portable Slugmaster Unloading Station	65 lbs.	\$910.00
SLUG Cart.	Metal Cart For All Above	40 lbs.	\$495.00



Professional Combat Training Targets

PRICES ARE PER 100 TARGETS.

PAGE 9

TARGET NUMBER	DESCRIPTION	SIZE ¹ / STOCK	TARGETS PER CARTON	SHIPPING WEIGHT PER CARTON	LIST PRICE PER 100
IAL-Q	IALEFI Advanced Tactical Training Target	22 ¹ / ₂ x 35 P	200	20	\$ 39.50
IAL-Q CB	IALEFI Advanced Tactical Training Target	19 x 31 CB	100	60	137.00
IAI-QP	VAR IALEFI Adv / Pelvic Training Target	22 ¹ / ₂ x 35 P	200	20	39.50
IAI-QR	VAR IALEFI Hostile Realistic Training Target	22 ¹ / ₂ x 35 P	200	20	39.50
TCT	Taylor Advanced Combat Target, Green Camouflage	16 x 25 P	200	14	32.00
TPT	Taylor Police Combat Target, Gray	18 x 25 P	200	14	32.00
YFA	Yavapi Firearms Academy Side One Camo Silhouette, Side Two Zero, 100 YD Small Bore, 25, 50, 100, 200 yd Simulation	18 ¹ / ₂ x 30 T	200	20	82.50
GTC	Gunsite Training Center Combat Silhouette, Brown Camo	18 x 30 P	200	15	50.00
JAS-2700	Santiago Police Night/Day Combat Survival Target	22 ¹ / ₂ x 35 P	200	20	50.00
JAS-2800	Vital Impact Replacement Center for JAS Targets	11 x 22 ¹ / ₂ P	500	25	16.00
JAS-2900	Vital Impact Replacement Center for JAS Targets	11 x 22 ¹ / ₂ P	500	25	16.00
JAS-3000	Vital Impact Replacement Center for JAS Targets	11 x 22 ¹ / ₂ P	500	25	16.00
JAS-3100	Santiago Combat Survival target, Screened Scoring	22 ¹ / ₂ x 35 P	200	20	50.00
HK-534	HK Intl. Training Div. Tactical Training Target	22 ¹ / ₂ x 35 P	100	11	76.25
G-64	Vital Organs Silhouette	20 x 30 P	100	12	42.00

Note *1*: P = Paper / 11 = Non NRA Targets

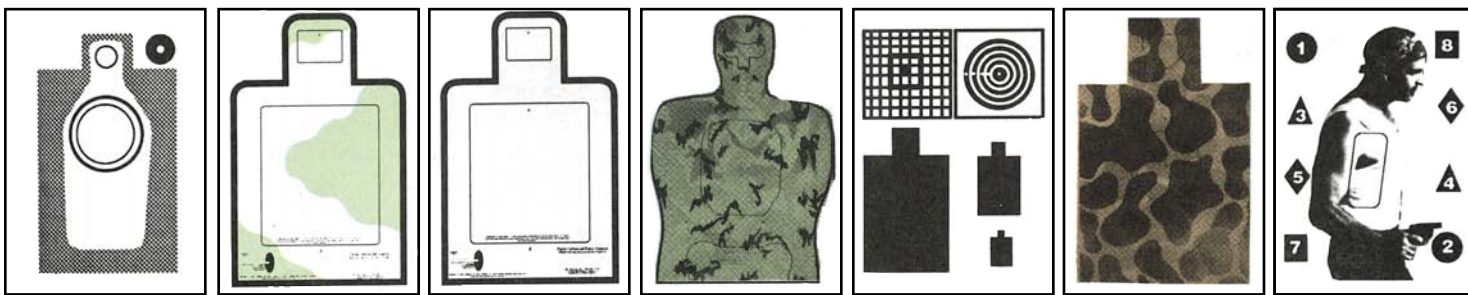

IAL-Q
IAL-Q CB

TCT

TPT

YFA

YFA Side 2

GTC

HK-534

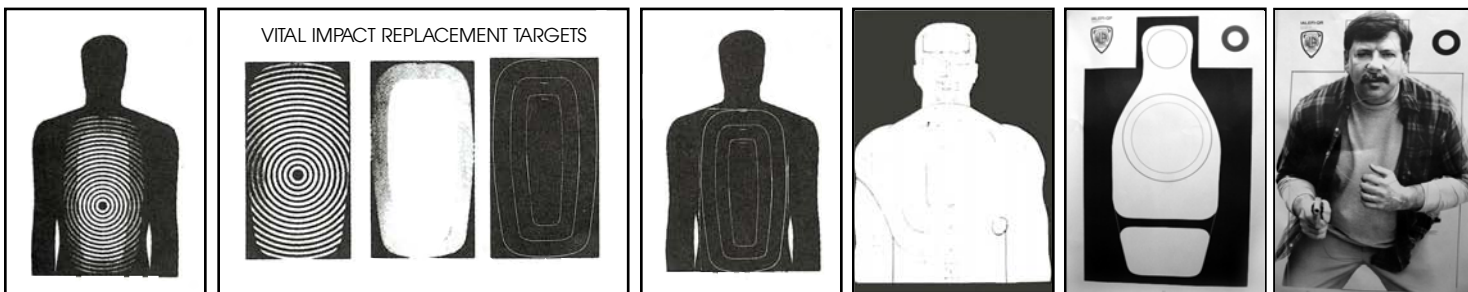

JAS-2700

JAS 2800
Police Survival
Training
11¹/₂" x 22¹/₂"

JAS 2900
Police Survival
Training
11¹/₂" x 22¹/₂"

JAS 3000
Police Survival
Training
11¹/₂" x 22¹/₂"

JAS-3100

G-64

IAL-QP

IAL-QR

Colored Police Silhouette Training Targets

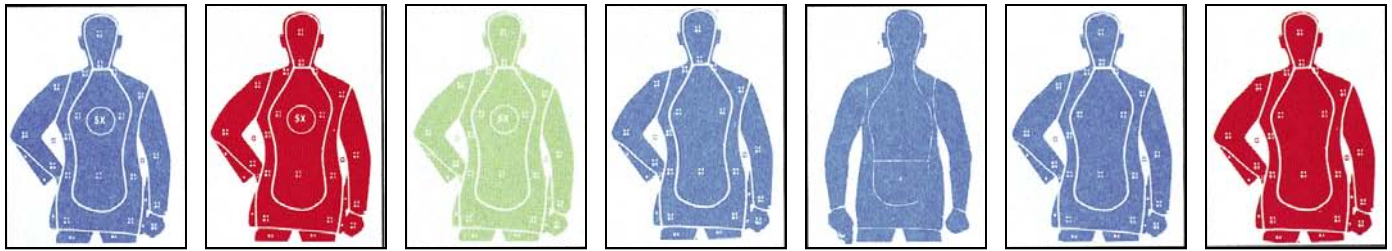

B-21 XFS BL

B-21 XFS OR

B-21 XFS GR

B-21 FS BL

B-21 FSR

B-21 E BL
B-21 E CB

B-21 E OR

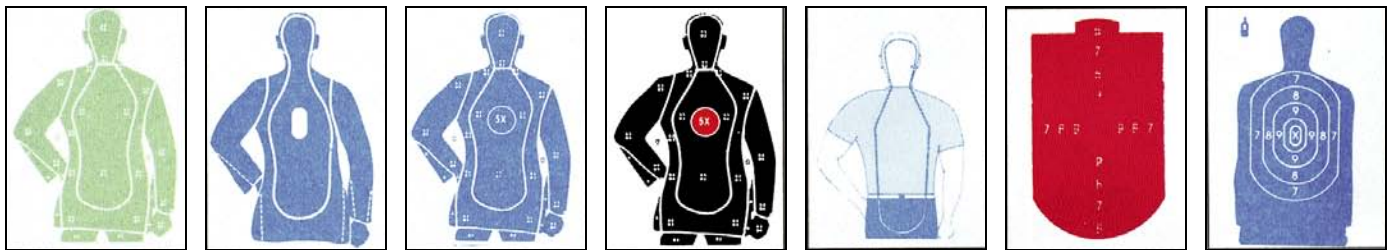

B-21 E GR

B-21 E3T

B-21 XR BL

B-21 XR G

B-21 PC BL

B-24 OR

B-27 FS BL



B-27 FS OR

B-27 FS GR

B-27 FS GY

B-27 E BL

B-27 E OR

B-27 E GR

B-27 PRO G



B-34 G

B-60 BL

TQ-20G

FBI-QIT G

CTT G

TSR-1 & II BL

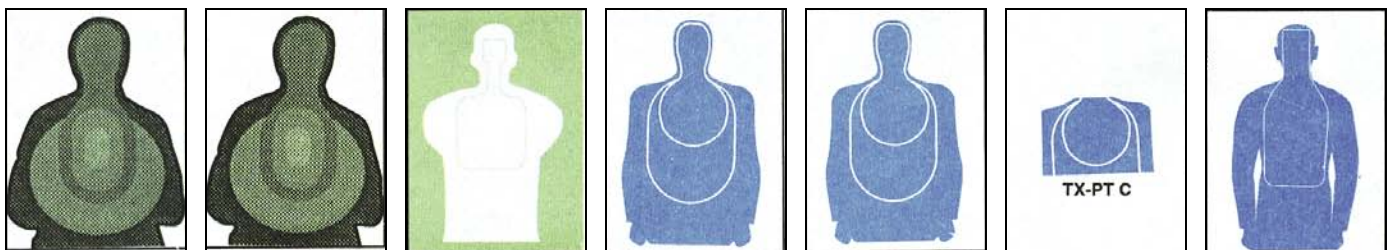

TSR-1 & II GR

TSR-1 & II CB

GA-FCGA

TX-PT

TX-PT CB

TX-PT C

MBN-9

Colored Police Silhouette Training Targets

TARGET NUMBER		DESCRIPTION	SIZE ¹ / STOCK		TARGETS PER CARTON	SHIPPING WEIGHT PER CARTON	LIST PRICE PER 100
B-21 XFS BL	VAR	Police Silhouette, Full Size (5X Ring) Blue	35 x 45	P	100	20	\$ 69.50
B-21 XFS OR	VAR	Police Silhouette, Full Size (5X Ring) Orange	35 x 45	P	100	20	69.50
B-21 XFS GR	VAR	Police Silhouette, Full Size (5X Ring) Green	35 x 45	P	100	20	69.50
B-21 FS BL	VAR	Police Silhouette, Full Size (No 5X Ring) Blue	35 x 45	P	100	20	69.50
B-21 FSR	VAR	Rochester, NY, Modified B-21 FBI TRC, Blue	35 x 45	P	100	20	69.50
B-21 E BL	25 YD	Police Silh., Economy, Reduced Silh. Full Size (No 5X Ring) Blue	22 ¹ / ₂ x 35	P	200	20	38.00
B-21 E OR	25 YD	Police Silh., Economy, Reduced Silh. Full Size (No 5X Ring) Orange	22 ¹ / ₂ x 35	P	200	20	38.00
B-21 E GR	25 YD	Police Silh., Economy, Reduced Silh. Full Size (No 5X Ring) Green	22 ¹ / ₂ x 35	P	200	20	38.00
B-21 E CB	25 YD	Police Silh., Economy, Reduced Silh. Full Size (No 5X Ring) Blue	23 x 35	CB	100	60	112.00
B-21 E3T	VAR	Florida Police Silhouette, Center Mass, Blue	22 ¹ / ₂ x 35	P	200	20	38.00
B-21 XR BL	50 FT	Police Silh., Reduced Silh., (5X Ring) Blue	22 ¹ / ₂ x 35	P	200	20	38.00
B-21 XR G	50 FT	Police Silh., Reduced Silh., Gallery (5X Ring) Orange Center	22 ¹ / ₂ x 35	P	200	20	53.00
B-21 PC BL	VAR	IRS Silhouette, Center Mass, (Modified B-21) Blue	24 x 38	P	200	20	56.00
B-24 OR	50 FT	Reduced 50 Yd. B-18 Rapid Fire Silh., Orange Center	12 x 20	T	250	24	28.00
B-27 FS BL	50 YD	Police Silhouette, Full Size, Blue	35 x 45	P	100	20	69.50
B-27 FS OR	50 YD	Police Silhouette, Full Size, Orange	35 x 45	P	100	20	69.50
B-27 FS GR	50 YD	Police Silhouette, Full Size, Green	35 x 45	P	100	20	69.50
B-27 FS GY	50 YD	Police Silhouette, Full Size, Light Scoring Lines, Grey	35 x 45	P	100	20	69.50
B-27 FSA GR	50 YD	Police Silhouette, Full Size Green	24 x 45	P	100	20	48.00
B-27 FSA BL	50 YD	Police Silhouette, Full Size Blue	24 x 45	P	100	20	48.00
B-27 E BL	50 YD	Police Silhouette, Economy, Full Silhouette, Blue	22 ¹ / ₂ x 35	P	200	20	38.00
B-27 E OR	50 YD	Police Silhouette, Economy, Full Silhouette, Orange	22 ¹ / ₂ x 35	P	200	20	38.00
B-27 E GR	50 YD	Police Silhouette, Economy, Full Silhouette, Green	22 ¹ / ₂ x 35	P	200	20	38.00
B-27 E GY	50 YD	Police Silhouette, Economy, Full Silhouette, Grey	22 ¹ / ₂ x 35	P	200	20	38.00
B-27 PRO G	VAR	Police Silhouette, Light Center Mass, Gallery, Orange X Ring	22 ¹ / ₂ x 35	P	200	20	55.00
B-34 G	50 FT	Police Silhouette, Reduction of B-27, Gallery, Orange X Ring	19 x 27	P	500	38	27.00
B-60 BL	VAR	Thug with Handgun, Blue	27 x 38	P	200	25	56.00
TQ-19 GR	25 YD	Police Silhouette, NRA Instructor Course Green	24 x 42	P	100	14	50.00
TQ-20 G	VAR	Police Silhouette, NRA Instructor Course, Reduced TQ-19 Gallery, Orange "K" Zones	14 x 20	P	500	25	18.00
FBI-QIT G	VAR	FBI Silhouette, Center Mass, 2 Bulls, Gallery, Orange Center	22 ¹ / ₂ x 35	P	200	20	55.00
FBI-QIT G CB	VAR	FBI Silhouette, 2 Bullseyes, Orange Center	19 x 30	CB	100	60	150.00
FBI IP 1 OR		FBI Bullseye Training Target, Orange	15 x 15	P	1000	30	16.00
CTT-G	VAR	US Secret Service Combat Transitional Target, Gallery, Orange 10 Ring	10 ¹ / ₂ x 18	P	500	20	16.50
TSR-I BL	VAR	US Treasury Silhouette, Center Mass, Blue	14 x 20	P	500	20	38.50
TSR-I GR	VAR	US Treasury Silhouette, Center Mass, Green	14 x 20	P	500	20	38.50
TSR-I CB	VAR	US Treasury Silhouette, Center Mass, Green	14 x 24	CB	100	40	110.00
TSR-II BL	VAR	US Treasury Silhouette, Center Mass, Blue	24 x 40	P	200	20	73.00
TSR-II GR	VAR	US Treasury Silhouette, Center Mass, Green	24 x 40	P	200	20	73.00
TSR-II CB	VAR	US Treasury Silhouette, Center Mass, Green	24 x 40	CB	100	90	180.00
GA-FCGA	VAR	Fulton Co. GA, SGT Police Silhouette, Green	27 x 38	P	200	25	54.50
TX-PT	VAR	Texas Police Training Silhouette, Blue	24 x 45	P	100	14	58.00
TX-PT CB	VAR	Texas Police Training Silhouette, Blue	24 x 45	CB	100	90	180.00
TX-PT C	VAR	Repair Center for TX-PT Target, Blue	12 ¹ / ₂ x 14	P	500	13	16.00
MBN-9	VAR	Mississippi Bureau of Narcotics Target, Blue	24 x 45	P	100	14	47.50

Note *1*: P = Paper / CB = 200 lb. cardboard / 11 = Non NRA Targets



Police Qualification & Combat Targets

PRICES ARE PER 100 TARGETS.

PAGE 12



B-21 XFS, B-21 CB, B-21 SC
B-21 SC, B-21 XNS, B-21 XR
B-21 XRG, B-21 XRGs



B-21 FS, B-21 E



B-27 FS, B-27 FSG, B-27 FSA
B-27 CG, B-27 NS, B-27 E
B-27 CB

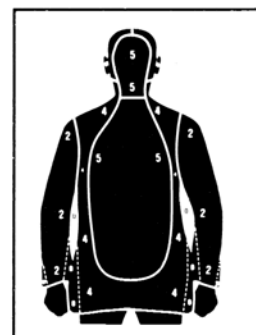

B-21 TRC



B-27 C



B-27 CGR



B-29 / B-34



B-21 XR

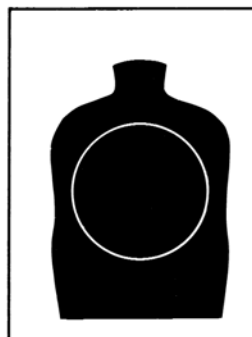

BT-1



BT-5



TQ-10 / TQ-11

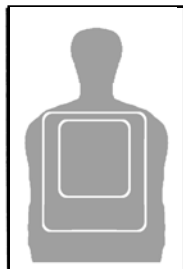

TQ-15 / TQ-16/TQ-15 CB

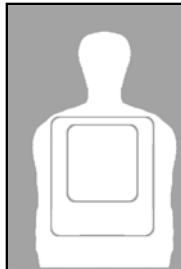

TQ-15 N

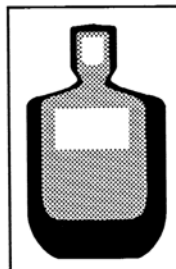

TQ-19 / TQ-20

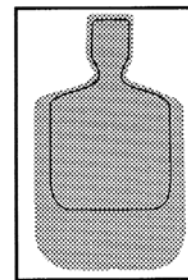

TQ-21 / TQ-22

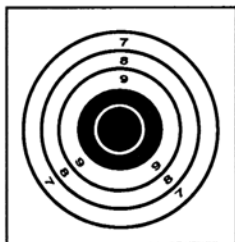

PM-1

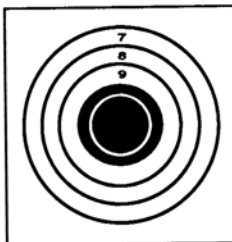

IP-1

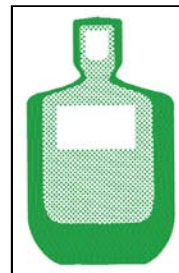

TQ-19 GR



1.800.243.8274 □ IN NJ 908.355.8600 □ FAX 908.355.1414

Police Qualification & Combat Targets

PRICES ARE PER 100 TARGETS.

PAGE 13

TARGET NUMBER		DESCRIPTION	SIZE ¹ / STOCK		TARGETS PER CARTON	SHIPPING WEIGHT PER CARTON	LIST PRICE PER 100
* B-21 XFS	VAR	Police Silhouette, Full Size (5X Ring) Black	35 x 45	P	100	20	\$ 66.50
* B-21 XFS	VAR	Police Silhouette, Full Size (5X Ring) Blue, Orange, or Green	35 x 45	P	100	20	69.50
* B-21 FS	VAR	Police Silhouette, Full Size (No 5X Ring) Black	35 x 45	P	100	20	69.50
* B-21 FS	VAR	Police Silhouette, Full Size (No 5X Ring) Blue	35 x 45	P	100	20	66.50
* B-21 CB	VAR	Police Silhouette, Full Size (5X Ring) Black	35 x 45	CB	100	100	342.00
* B-21 SC	VAR	Police Silhouette, Full Size (5X Ring) Scoring Screened, Black	35 x 45	P	100	20	66.50
* B-21 TRC	VAR	Police Silhouette, FBI Tactical Revolver Course	35 x 45	P	100	20	66.50
* B-21 XNS	VAR	Police Silhouette, New Standard, Reduced Silh. (5X Ring) Black	27 x 38	P	200	25	54.00
* B-21 E	VAR	Police Silhouette, Economy, Reduced Silhouette (No 5X Ring) Black or Blue	22 1/2 x 35	P	200	20	31.00
* B-21 E	VAR	Police Silhouette, Economy, Reduced Silhouette (No 5X Ring) Orange or Green	22 1/2 x 35	P	200	20	38.00
* B-21 E CB	VAR	Police Silhouette, Economy, Reduced Silhouette (No 5X Ring) Blue	23 x 35	CB	100	75	112.00
* B-21 XR	VAR	Police Silhouette, Reduced Silhouette (5X Ring) Black	22 1/2 x 35	P	200	20	37.00
* B-21 XR BL	VAR	Police Silhouette, Reduced Silhouette (5X Ring) Blue	22 1/2 x 35	P	200	20	38.00
B-27 FS	50 YD	Police Silhouette, Full Size, Black	35 x 45	P	100	20	66.50
B-27 FS	50 YD	Police Silhouette, Full Size, Blue	35 x 45	P	100	20	66.50
B-27 FS	50 YD	Police Silhouette, Full Size, Orange	35 x 45	P	100	20	66.50
B-27 FS	50 YD	Police Silhouette, Full Size, Green	35 x 45	P	100	20	66.50
* B-27 FSG	50 YD	Police Silhouette, Full Size, Light Scoring Rings, Grey	35 x 45	P	100	20	66.50
B-27 FSA	50 YD	Police Silhouette, Full Size, Black	24 x 45	P	100	14	48.00
B-27 C GR	VAR	Repair Center for all B-27 Targets	12 1/2 x 19	P	500	15	15.75
B-27 CB	50 YD	Police Silhouette, Full Size, Black or Green	24 x 45	CB	100	90	180.00
* B-27 NS	VAR	Police Silhouette, New Standard, Black	27 x 38	P	200	25	54.00
B-27 E	50 YD	Police Silhouette, Economy (Full Silhouette), Black	22 1/2 x 35	P	200	20	37.00
* B-27 E	50 YD	Police Silhouette, Economy (Full Silhouette), Blue, Orange, or Green	22 1/2 x 35	P	200	20	39.00
* B-27 PRO	VAR	Police Silhouette, Light Center Mass, Economy	22 1/2 x 35	P	200	20	49.00
* B-27 R	VAR	Police Silhouette, Reduced (Reduced Silhouette), Black	22 1/2 x 35	P	200	20	36.75
B-27 C		Repair Center for all B-27 Targets, Black	12 1/2 x 19	P	500	13	15.50
B-29	50 FT	Police Silhouette, Reduction of B-27	14 x 21	P	500	25	12.50
B-34	25 YD	Police Silhouette, Reduction of B-27, Black	19 x 27	P	500	38	17.00
* B-60	VAR	Thug with Handgun, Black or Blue	27 x 38	P	200	25	54.00
* BT-1	VAR	Police Silhouette, Torso, Single Bull, Black	22 1/2 x 35	P	200	20	39.00
* BT-5	25 YD	Silhouette Training Target	18 x 24	P	200	15	44.00
TQ-10	25 YD	Police Training, Chest Silhouette, Grey	22 1/2 x 35	P	200	20	37.00
TQ-11	50 FT	Police Training, Chest Silhouette, Reduction of TQ-10	14 x 22	P	500	25	17.00
TQ-15	25 YD	Police Silhouette, NRA Instructor Course, Grey	24 x 45	P	100	14	48.00
* TQ-15 CB	25 YD	Police Silhouette, NRA Instructor Course Reverse Silh	24 x 45	CB	100	90	180.00
* TQ-15 R	25 YD	US Customs Reduced TQ-15	8 1/2 x 12	P	1000	20	9.80
* TQ-15 N	25 YD	Police Silhouette, NRA Instructor Course Green	24 x 45	P	100	14	48.00
TQ-16	50 FT	Police Silhouette, Reduced TQ-15	14 x 20	P	500	25	17.00
TQ-19	25 YD	Police Silhouette, NRA Instructor Course	24 x 42	P	100	12	48.00
TQ-20	50 FT	Police Silhouette, Reduced TQ-19	14 x 20	P	500	25	17.00
TQ-21	25 YD	Police Silhouette, NRA Instructor L E Training Target, Grey	24 x 42	P	100	12	48.00
TQ-22	50 FT	Police Silhouette, Reduced TQ-21, Grey	14 x 20	P	500	25	17.00
* IP-1	25 YD	International Police Army "L", Full 7 Ring, 3-3/8" X-Ring	16 1/2 x 16 1/2	P	1000	35	12.50
* PM-1	25 YD	Police Match Army "L", Full 7 Ring, 2 1/2" X-Ring	16 1/2 x 16 1/2	P	1000	35	12.50

Note *1*: P = Paper / CB = 200 lb. cardboard / * Non NRA target

Federal Law Enforcement Training Targets Customs

DEA / DOD / FBI / IRS / Secret Service / Treasury / RCMP / DHS

PRICES ARE PER 100 TARGETS.

PAGE 14

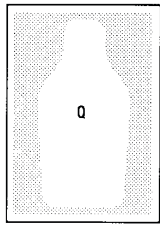

FBI-Q
FBI-QR

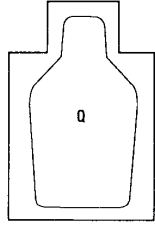

FBI-Q CB

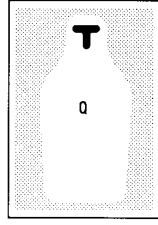

FBI-Q SRC

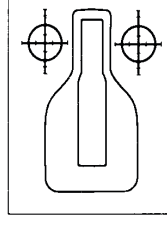

FBI-QIT
FBI-QIT CB

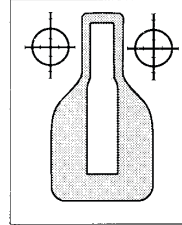

FBI QIT SC

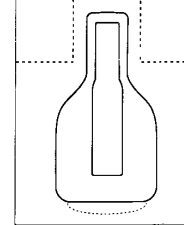

FBI QIT 97
FBI QIT 97 CB

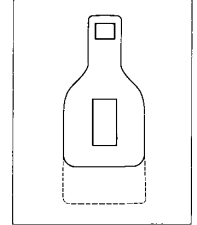

FBI QIT 99

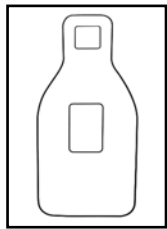

FBI QIT 03

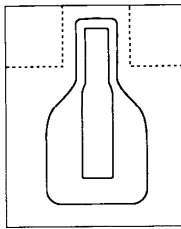

FBI QIT M
FBI QIT M CB

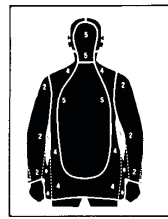

B21 TRC

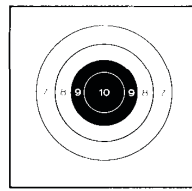

FBI-IP-I

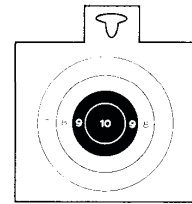

FBI-IP CB

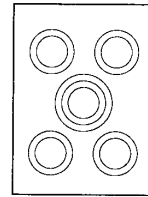

FBI-CIR P

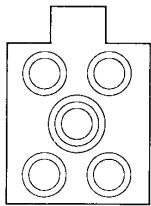

FBI-CIR CB

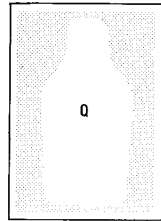

DEA-Q

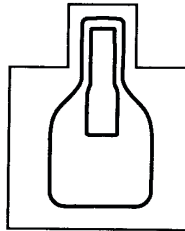

DEA-QST CB

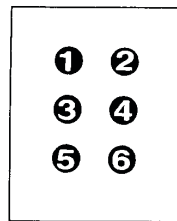

DEA DOT
DEA-DOT CB

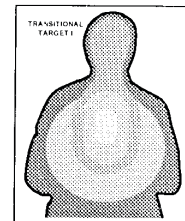

TSR-I / TSR-II
TSR-1 CB / TSR-II CB



CAT I R BMT

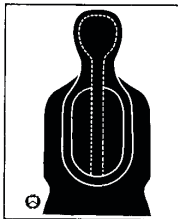

CAT-I / CAT-II
CAT-1R

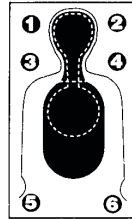

CAT-III

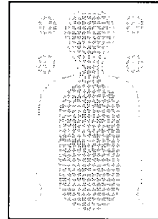

CAT-IV

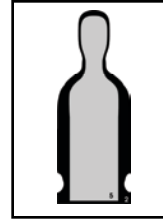

CAT-V

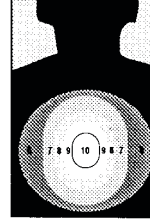

CTT



MPPC



B-27 C WHT

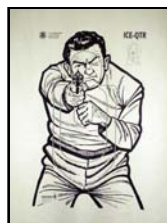

B-60 ICE QT

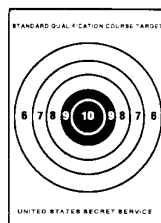

SQC-1

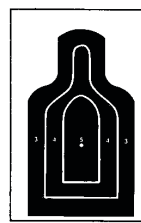

DOD - M9

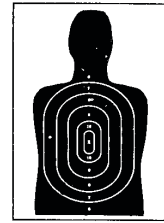

RCMP-38 / RCMP-24



TS-CS

Federal Law Enforcement Training Targets Customs

DEA / DOD / FBI / IRS / Secret Service / Treasury / RCMP / DHS

PRICES ARE PER 100 TARGETS.

PAGE 15

TARGET NUMBER		DESCRIPTION	SIZE ¹ / STOCK	TARGETS PER CARTON	SHIPPING WEIGHT PER CARTON	LIST PRICE PER 100
FBI-Q	VAR	FBI Silhouette, Center Mass, Training Target	20 x 32 P	200	20	\$ 45.00
FBI-Q CB	VAR	FBI Silhouette, Center Mass, Training Target	19 x 31 CB	100	60	120.00
FBI-Q SRC	VAR	FBI Silhouette, Scoped Rifle Course	20 x 32 P	200	22	45.00
FBI-Q R	VAR	FBI Silhouette, Center Mass, Training Target	18 x 28 P	200	16	42.00
FBI-QIT	VAR	FBI Silhouette, Center Mass, 2 Bull Training Target	22 ¹ / ₂ x 35 P	200	20	45.00
FBI-QIT CB	VAR	FBI Silhouette, Center Mass, 2 Bull Training Target	19 x 31 CB	100	60	120.00
FBI-QIT M	VAR	FBI Silhouette, Center Mass, Training Target	23 x 35 P	200	20	45.00
FBI-QIT M CB	VAR	FBI Silhouette, Center Mass, Training Target	19 x 31 CB	100	60	120.00
FBI-QIT SC	VAR	FBI Silhouette, 2 Bulls, Training Target, Screened	23 x 35 P	200	20	45.00
FBI-QIT 97	VAR	FBI Silhouette, Modified Center Mass, Training Target	23 x 35 P	200	20	45.00
FBI-QIT 97 CB	VAR	FBI Silhouette, Modified Center Mass, Training Target	19 x 31 CB	100	60	120.00
FBI-QIT 99	VAR	FBI Silhouette, Modified Center Mass, Training Target	22 ¹ / ₂ x 35 P	200	20	45.00
FBI-QIT 99 CB	VAR	FBI Silhouette, Modified Center Mass, Training Target	19 x 31 CB	100	60	120.00
FBI-QIT 03	VAR	FBI Silhouette, Modified Center Mass, Training Target	22 ¹ / ₂ x 35 P	200	20	45.00
FBI-QIT 03 CB	VAR	FBI Silhouette, Modified Center Mass, Training Target	19 x 31 CB	100	60	120.00
B-60 ICE QT	VAR	Thug with Handgun, DHS-ICE Training Target	22 ¹ / ₂ x 35 P	200	20	47.75
B-60 ICE R	VAR	Thug with Handgun, DHS-ICE Training Target Reduced	17 ¹ / ₂ x 22 ¹ / ₂ P	200	16	42.00
B-60 ICE CB	VAR	Thug with Handgun, DHS-ICE Training Target	24 x 38 CB	100	90	180.00
B-21 TRC	VAR	FBI Police Silh., Training Revolver Course, Full Size (B-21 Rev)	35 x 45 P	100	20	66.50
FBI-IP 1	VAR	FBI Bullseye Training Target	15 x 15 P	1000	30	12.50
FBI-IP CB	VAR	FBI Bullseye Training Target	19 x 31 CB	100	60	120.00
FBI-CIR P	VAR	FBI, 5 Bull, Training Target	19 x 31 P	200	20	45.00
FBI-CIR CB	VAR	FBI, 5 Bull, Training Target	19 x 31 CB	100	60	120.00
DEA-Q	VAR	DEA Silhouette, Center Mass, Training Target	20 x 32 P	200	20	45.00
DEA-QST CB	VAR	DEA Quality Scored Silhouette Target (Mod Q)	19 x 31 CB	100	60	120.00
DEA-DOT	VAR	DEA-DOT Training Target, 6 Bulls	23 x 35 P	200	20	45.00
DEA-DOT CB	VAR	DEA-DOT Training Target, 6 Bulls	19 x 31 CB	100	60	120.00
TSR-I	VAR	US Treasury Silhouette, Center Mass, Blue or Green	14 x 20 P	500	20	38.50
TSR-I CB	VAR	US Treasury Silhouette, Center Mass, Green	14 x 20 CB	100	40	110.00
TSR-II	VAR	US Treasury Silhouette, Center Mass, Blue or Green	24 x 40 P	200	22	73.00
TSR-II CB	VAR	US Treasury Silhouette, Center Mass, Green	24 x 40 CB	100	90	180.00
CAT-I	VAR	US Customs Silhouette, Center Mass, Gray	24 x 40 P	200	22	73.00
CAT-I R	VAR	US Customs Silhouette, Center Mass, Gray	18 x 35 P	200	20	52.50
CAT-II	VAR	US Customs Silhouette, Center Mass, Gray	14 x 20 P	500	20	36.75
CAT-III	VAR	US Customs Silhouette, Center Mass, Gray	18 x 35 P	200	20	52.50
CAT-IV	VAR	US Customs Silhouette Target PMS, Gray	18 x 35 P	200	16	52.50
CAT V		US Customs Silhouette Target	18 x 35 P	200	16	52.50
CAT I R BMT	VAR	US Customs Silhouette Modified Grey	18 x 35 P	200	20	52.50
CTT	VAR	US Secret Service Combat Transitional Target	10 ¹ / ₂ x 18 P	500	20	14.00
MPPC	VAR	US Secret Service Silhouette, Hostile	22 ¹ / ₂ x 35 P	200	20	45.00
MPPC CB	VAR	US Secret Service Silhouette, Hostile Cardboard	22 ¹ / ₂ x 35 CB	100	60	112.00
SQC-1	15 YD	US Secret Service Qualification Bullseye Target	10 x 17 ¹ / ₂ P	500	19	14.00
B-21 PC	VAR	IRS Silhouette, Center Mass, Black or Blue	24 x 38 P	200	25	56.00
B-27 C WHT		White B-27 Center Target	19-1/2 x 19 P	500	13	15.50
DOD-M9	25 M	US Army 25 Meter E Silhouette 9mm Pistol Target	24 x 40 P	200	22	73.00
RCMP-38	VAR	RCMP Silhouette, Standard Police Profile (1508-92-06)	23 ¹ / ₂ x 38 P	200	24	46.00
RCMP-24	VAR	RCMP Silh., Standard Half Police Profile (1508-1-92-06)	12 ⁵ / ₈ x 24 P	500	22	20.00
TS-CS	VAR	Target Silhouette, Commando Soldier, Canada	17 ¹ / ₂ x 45 P	500	50	33.00

Note *1": P = Paper / T = Tagboard / CB = 200 lb. cardboard

1.800.243.8274 □ IN NJ 908.355.8600 □ FAX 908.355.1414



State & Municipal Police Training Targets

PRICES ARE PER 100 TARGETS.

PAGE 16



B - 27A
CALIFORNIA

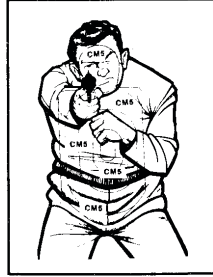

B-60CT
CONNECTICUT

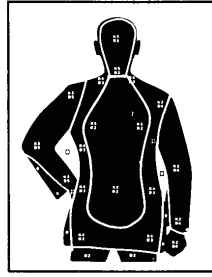

B-21E
FLORIDA

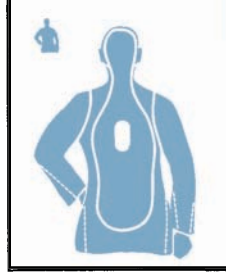

B-21 E3T
FLORIDA

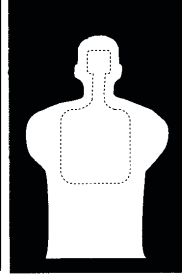

GA-FCGA
SQT

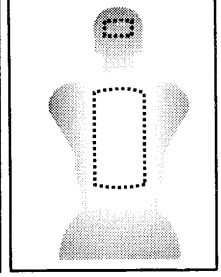

GA-PT
GEORGIA

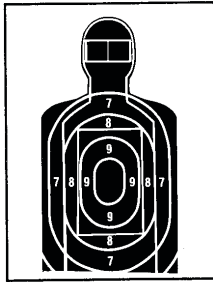

IL - PT
ILLINOIS

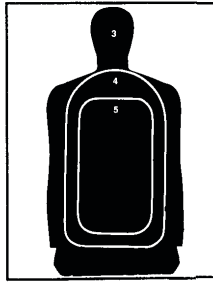

ILE
IOWA



LA-P1 (P.O.S.T.)
LOUISIANA

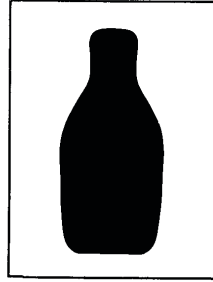

EC-CM
MAINE

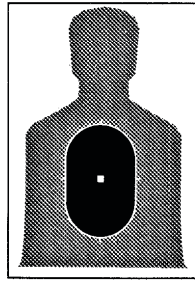

B-27 MSP
MASSACHUSETTS

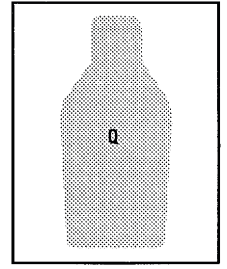

MA-Q
MASSACHUSETTS



MI-TC 71
MICHIGAN



MI-XTC 71
MICHIGAN

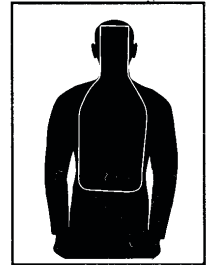

MBN-9
MISSISSIPPI



B60-NYT
NY TRANSIT

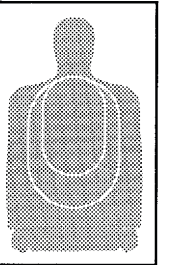

B27 N.Y.S.P.
NEW YORK

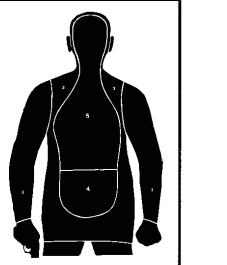

B-21 FS R
ROCHESTER NY

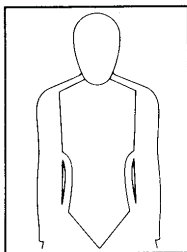

OH-PT / OH-OPOTA
OHIO

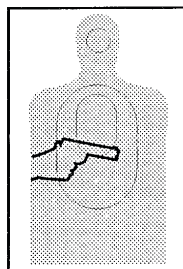

OK-CL / B-27M
OKLAHOMA

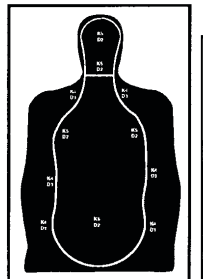

SC-K5
SOUTH CAROLINA

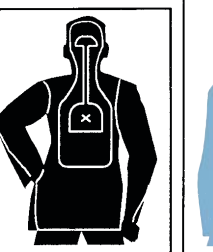

B21-STL
ST. LOUIS

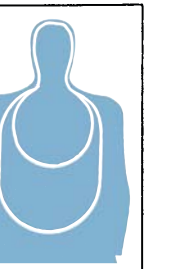

TX-PT
TEXAS

State & Municipal Police Training Targets

PRICES ARE PER 100 TARGETS.

PAGE 17

TARGET NUMBER		DESCRIPTION	SIZE ¹ / STOCK	TARGETS PER CARTON	SHIPPING WEIGHT PER CARTON	LIST PRICE PER 100
B-27 A	50 YD	California Combat Silhouette (Scoring 10-3)	24 x 45 P	100	14	\$ 48.00
B-27 TR	25 YD	California Combat Target Reduced 50 YD. B-27	22 ¹ / ₂ x 35 P	200	20	48.00
B-60 CT	VAR	Connecticut MPTC, Thug / Handgun, CM-5 Scoring, Black	22 ¹ / ₂ x 35 P	200	20	49.00
B-21 E	VAR	Florida Police Reduced Silhouette, Black or Blue No "X" Ring	22 ¹ / ₂ x 35 P	200	25	38.00
B-21 E CB	VAR	Florida Police Reduced Silhouette Blue	23 x 35 CB	100	75	112.00
B-21 E3T	VAR	Florida Police Silhouette, Center Mass, Blue	22 ¹ / ₂ x 35 P	200	20	38.00
GA-FC GA	VAR	Fulton Co. GA SQT Police Silhouette, Green	27 x 38 P	200	25	54.50
GA-PT NS	VAR	Georgia State Police Silhouette Training Target	27 x 38 P	200	25	53.00
GA-PT R	VAR	Georgia State Police Silhouette Training Target	22 ¹ / ₂ x 35 P	200	49	49.00
IL-PT	VAR	Illinois Police Training Silhouette	22 ¹ / ₂ x 35 P	200	49	48.00
ILE	VAR	Iowa LE Academy Modified B-27 (Scoring 5, 4, 3)	24 x 45 P	100	14	49.00
B-21PC	VAR	Kentucky Police Silhouette, Screened Center Mass Black or Blue	24 x 38 P	200	25	56.00
LA-P1	VAR	Louisiana Police Police Training Silhouette target, (P.O.S.T.)	24 x 45 P	100	14	49.00
EC-CM	VAR	Maine "Q" Silhouette, Center Mass	22 ¹ / ₂ x 35 P	200	20	49.00
MA-Q	VAR	Massachusetts Criminal Justice Police "Q" Target	22 ¹ / ₂ x 35 P	200	20	49.00
MA-PT	VAR	Massachusetts Criminal Justice Police Silhouette	22 ¹ / ₂ x 35 P	200	20	49.00
MA-PT MSP	VAR	Massachusetts State Police Training Silhouette	22 ¹ / ₂ x 35 P	200	20	49.00
MA-PT MSP C	VAR	Repair Center for B-27 MSP	12 ¹ / ₂ x 19 P	500	13	15.50
MI-TC 71	VAR	Michigan Law Enf. Training Council Target	22 ¹ / ₂ x 35 P	200	20	36.00
MI-XTC 71	VAR	Michigan Law Enf. Training Council Target	22 ¹ / ₂ x 35 P	200	20	36.00
MI-XTC 71C	VAR	Repair Center for MI-XTC 71	12 ¹ / ₂ x 19 P	500	13	15.50
MBN-9	VAR	Mississippi Bureau of Narcotics Target, Blue	24 x 45 P	100	14	49.00
B-27 NYSP	VAR	New York State Police Training Silhouette	24 x 45 P	100	14	49.50
B-27 NYSPC		Repair Center for B-27 NYSP	17 ¹ / ₂ x 19 P	500	13	15.50
B-60 NYT	VAR	New York Transit Police Thug with Handgun	22 ¹ / ₂ x 35 P	200	25	49.00
OH-PT	VAR	Ohio State Police Silhouette Training Target (OPOTA)	25 x 38 P	200	25	53.00
OH-PT CB		Ohio State (OPOTA) Silhouette	24 x 35 CB	100	65	154.00
OK-CL	VAR	Oklahoma Training Council CLEET (B-27 M) Target, Gray	22 ¹ / ₂ x 35 P	200	20	38.00
B-21 FSR	VAR	Rochester NY Modified TRC, Blue	35 x 45 P	100	20	69.50
SC-K5	VAR	So. Carolina CJ Academy Training Target, K-5 Scoring	24 x 40 P	100	20	49.00
B-21 STL	VAR	St. Louis Police Silhouette Training Target	35 x 45 P	100	20	66.50
TX-PT	VAR	Texas Police Training Silhouette, Blue	24 x 45 P	100	14	58.00
TX-PT CB	VAR	Texas Police Training Silhouette, Blue	24 x 45 CB	100	90	190.00
TX-PT C	VAR	Repair Center for TX-PT Target, Blue	12 ¹ / ₂ x 14 P	500	13	15.50

Note *1": P = Paper / T = Tagboard / CB = 200 lb. cardboard

500 Series Realistic Situations Police Combat Targets

SP-5500: 50 each – 500 Targets

\$232⁰⁰

500 Assorted Series 500 REALISTIC SITUATION™ Training Targets YOUR Selection of 10 Targets.

(List Value \$288.75) Shipping Weight: 55 lbs.

SP-5200: 50 each – 200 Targets

\$92⁷⁵

200 Assorted Series 500 REALISTIC SITUATION™ Training Targets YOUR Selection of 4 Targets.

(List Value \$115.00) Shipping Weight: 22 lbs.

SP-SWAT: 400 Targets

\$143⁰⁰

400 Assorted Countersniper Training Targets (ST-1001, ST-1002, ST-1003, ST-1004)

(List Value \$180.00) Shipping Weight: 12 lbs.

STS-1:

\$44⁹⁵

Shotlog Data Card System™

System Includes

- 40 – 8-1/2 x 5-1/2 Shot Log / Data Cards
- 3 ring binder
- 40 – 8-1/2 x 11 T Section Targets
- 40 Mini Targets
- Thermometer

Shipping Weight: 1 lb.

Note *1": P = Paper / T = Tagboard / C = Center / CB = 200 lb. cardboard / CH = Chip Board / * Non NRA target



515 – Hostile / Friendly / Hostile



516 – Friendly / Hostile / Friendly



514

500 Series Realistic Situations Police Combat Targets



517



518



519



520

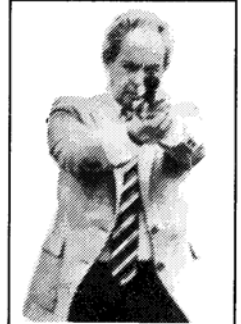

521



522

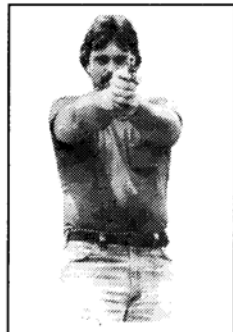

523

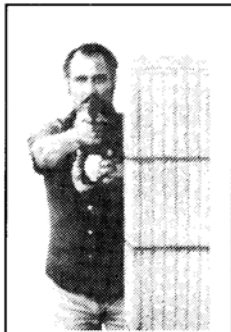

524



525

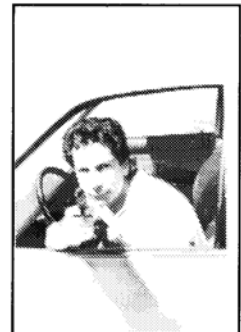

526

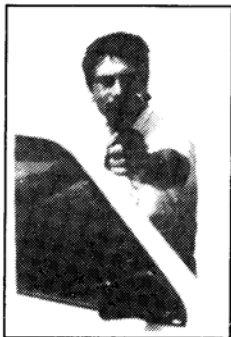

527

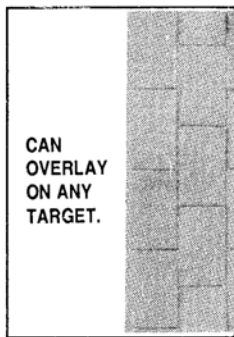

528



522 / 528



529

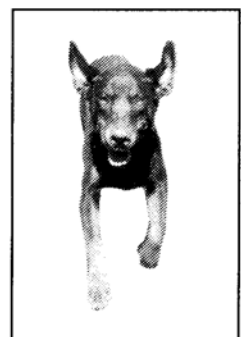

531



532



533



534



535



536

500 Series Realistic Situations Police Combat Targets

PRICES ARE PER 100 TARGETS.

PAGE 20

TARGET NUMBER	DESCRIPTION	SIZE ¹ / STOCK	TARGETS PER CARTON	SHIPPING WEIGHT PER CARTON	LIST PRICE PER 100
* 514	Thug Behind the Wall, Blue	22 ¹ / ₂ x 35 P	100	11	\$57.75
* 515	Hostile/Friendly/Hostile - 3 Silhouettes Blue	35 x 45 P	100	20	57.75
* 516	Friendly/Hostile/Friendly - 3 Silhouettes Blue	35 x 45 P	100	20	57.75
* 517	Hostile Man with Handgun	22 ¹ / ₂ x 35 P	100	11	57.75
* 518	Friendly Man without Gun	22 ¹ / ₂ x 35 P	100	11	57.75
* 519	Hostile Woman with Handgun	22 ¹ / ₂ x 35 P	100	11	57.75
* 520	Friendly Woman with Handgun & Badge	22 ¹ / ₂ x 35 P	100	11	57.75
* 521	Hostile Man with Handgun	22 ¹ / ₂ x 35 P	100	11	57.75
* 522	Hostile Man with Shotgun	22 ¹ / ₂ x 35 P	100	11	57.75
* 523	Hostile Man with Handgun	22 ¹ / ₂ x 35 P	100	11	57.75
* 524	Friendly Man behind Wall with Handgun & Badge	22 ¹ / ₂ x 35 P	100	11	57.75
* 525	Hostile Man behind Wall with Handgun	22 ¹ / ₂ x 35 P	100	11	57.75
* 526	Hostile Man inside Auto with Handgun	22 ¹ / ₂ x 35 P	100	11	57.75
* 527	Hostile Man behind Car Door with Handgun	22 ¹ / ₂ x 35 P	100	11	57.75
* 528	Brick Wall Overlay (25 pack)	22 ¹ / ₂ x 35 P	25	4	23.00
* 529	Friendly Man inside Auto with Handgun & Badge	22 ¹ / ₂ x 35 P	100	11	57.75
* 530	Police, 5 Bulls, Center Mass, Advanced Multi-target	22 ¹ / ₂ x 35 P	100	11	57.75
* 530 TM	Training Manual for 530 Target - 10 multi-target exercises		1	1	9.75
* 531	Attacking Dog	22 ¹ / ₂ x 35 P	100	11	57.75
* 532	Hostile Woman with Handgun	22 ¹ / ₂ x 35 P	100	11	57.75
* 533	Friendly Woman with Handgun & Badge	22 ¹ / ₂ x 35 P	100	11	57.75
* 534	Hostile Running Man with Handgun (Profile)	22 ¹ / ₂ x 35 P	100	11	57.75
* 535	Hostile Running Man with Handgun (Frontal)	22 ¹ / ₂ x 35 P	100	11	57.75
* 536	Friendly Running Man in Uniform with Handgun	24 x 45 P	100	11	57.75
* 537-Q	Hostile Man with Handgun - FBI "Q" Scoring	22 ¹ / ₂ x 35 P	100	11	57.75
* 560-Q	Hooded Hostile Man with Handgun, FBI "Q" Scoring	22 ¹ / ₂ x 35 P	100	11	57.75
* 561	Hostile Man with Male Hostage	20 x 29 P	100	11	57.75
* 562	Hooded Hostile Man with Female Child Hostage	20 x 29 P	100	11	57.75
* 563	Hostile Woman with Shotgun	20 x 29 P	100	11	57.75

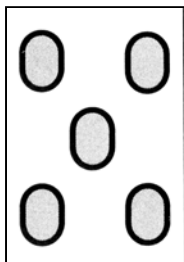

530



537-Q

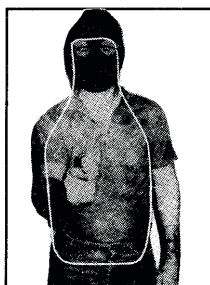

560-Q

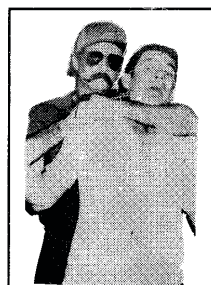

561

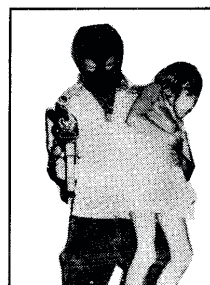

562



563

REALISTIC/SITUATION™ POLICE "COUNTER SNIPER" TARGETS

* ST-1001	Head - Rear Profile	12 x 14 P	100	3	\$45.00
* ST-1002	Head - Front Profile	12 x 14 P	100	3	45.00
* ST-1003	Head - Side Profile	12 x 14 P	100	3	45.00
* ST-1004	Hostile with Friendly Hostage	19 x 25 P	100	4	45.00
* RT-1	Shotlog Replacement Target	8-1/2 x 11 P	36	1	6.25

Note *1": P = Paper / T = Tagboard / CB = 200 lb. cardboard / * Non NRA target



ST-1001

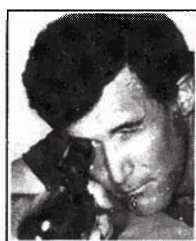

ST-1002

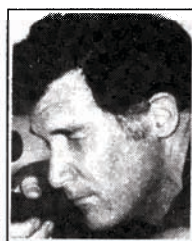

ST-1003



ST-1004

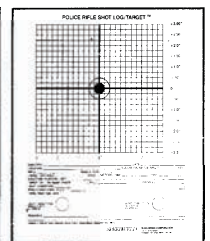

RT-1



1.800.243.8274 □ IN NJ 908.355.8600 □ FAX 908.355.1414

Police Indoor Range Target Gallery & Sighting Targets

PRICES ARE PER 100 TARGETS.

PAGE 21

TARGET NUMBER	DESCRIPTION	SIZE ¹ / STOCK	TARGETS PER CARTON	SHIPPING WEIGHT PER CARTON	LIST PRICE PER 100
* G-22	25 FT Police Silhouette (5X Ring), Black	9 ¹ / ₂ x 14	P 1000	12	\$ 8.00
* G-47	50 FT Police Silhouette (5X Ring), Black	14 x 23	P 500	22	25.25
B-29	50 FT Police Silhouette Reduced B-27 Black	14 ¹ / ₂ x 21 ¹ / ₂	P 500	25	12.50
* G-21	25 FT Thug with Handgun, Black	9 x 13	P 1000	10	8.00
* G-46	50 FT Thug with Handgun, Black	14 x 23	P 500	22	25.25
TQ-11	50 FT Police Training, Chest Silhouette, Reduced TQ-10	14 x 22	P 500	22	17.00
* PR-25	25 FT Prehle Silhouette, Black	9 ¹ / ₂ x 13 ¹ / ₂	P 1000	12	7.50
* PT-40MOA	Handgun and Rifle Skill Target	22 ¹ / ₂ x 35	P 100	10	58.00
* TSR-1	VAR US Treasury Silhouette, Center Mass, Blue or Green	14 x 20	P 500	20	38.50
* CAT-II	VAR US Customs Silhouette, Center Mass, Gray	14 x 20	P 500	20	38.00
* CTT	VAR US Secret Service Combat Transitional Target	10 ¹ / ₂ x 18	P 500	15	14.00
TQ-16	50 FT NRA Police Silhouette, Reduced TQ-15, Gray	14 x 20	P 500	20	17.00
TQ-20	50 FT NRA Police Silhouette, Reduced TQ-19	14 x 20	P 500	20	17.00
TQ-22	50 FT NRA Police Silhouette, Reduced TQ-21, Gray	14 x 20	P 500	20	17.00
* TT-R	Training Target Right Hand Shooters	22 ¹ / ₂ x 35	P 100	10	54.50
* TT-L	Training Target Left Hand Shooters	22 ¹ / ₂ x 35	P 100	10	54.50
* 519-TQ	Hostile Woman With Gun and TQ-15 Scoring Lines	22 ¹ / ₂ x 35	P 100	11	57.75
* 522-TQ	Hostile Man With Shotgun and TQ-15 Scoring Lines	22 ¹ / ₂ x 35	P 100	11	57.75
* 523-TQ	Hostile Man With Gun and TQ-15 Scoring Lines	22 ¹ / ₂ x 35	P 100	11	57.75
* 532-TQ	Hostile Woman With Gun and TQ-15 Scoring Lines	22 ¹ / ₂ x 35	P 100	11	57.75



G-22 G-47

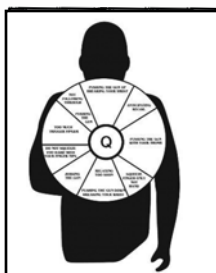

TT-R



B-29



G-21 G-46

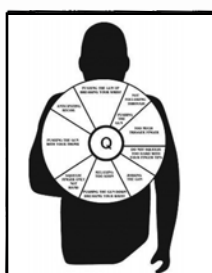

TT-L

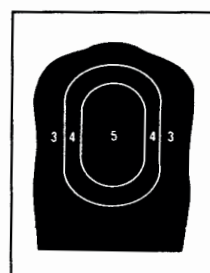

TQ-11



PR-25

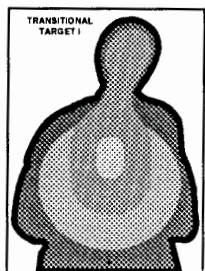

TSR-1

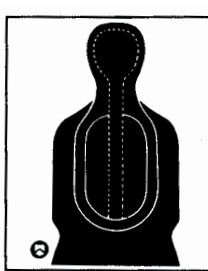

CAT-II

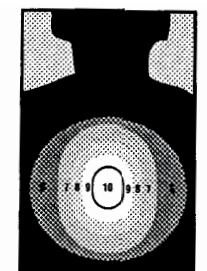

CTT

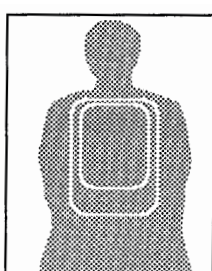

TQ-16

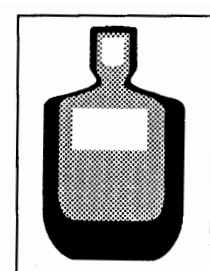

TQ-20

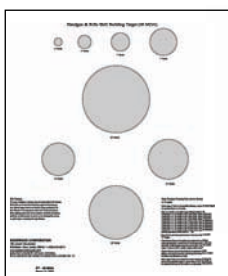

PT-40 MOA

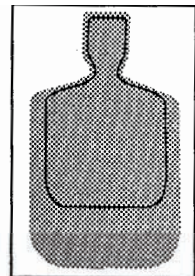

TQ-22



519-TQ

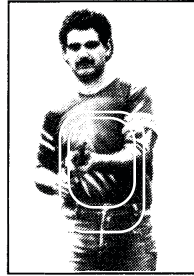

522-TQ



523-TQ



532-TQ



Backers, Silhouette Bobbers, Facers, Pastes

PRICES ARE PER 100 TARGETS.

PAGE 22

TARGET NUMBER	DESCRIPTION	SIZE' / STOCK	TARGETS PER CARTON	SHIPPING WEIGHT PER CARTON	LIST PRICE PER 100
* BAC-48	Backer Single Wall 1/8" Corrugated	36 x 48 CB	100	155	\$165.00 Net
* BAC-46	Backer Single Wall 1/8" Corrugated	36 x 46 CB	100	150	159.00 Net
* BAC-45	Backer Single Wall 1/8" Corrugated	35 x 45 CB	100	145	127.00 Net
* BAC-45A	Backer Single Wall 1/8" Corrugated	24 x 45 CB	100	90	95.00 Net
* BAC-45B	Backer Single Wall 1/8" Corrugated	14 x 45 CB	100	50	70.00 Net
* BAC-38	Backer Single Wall 1/8" Corrugated	27 x 38 CB	100	80	95.00 Net
* BAC-35	Backer Single Wall 1/8" Corrugated	22 1/2 x 35 CB	100	60	76.00 Net
* BAC-35A	Backer Single Wall 1/8" Corrugated	24 x 35 CB	100	60	91.00 Net
* BAC-22	Backer Single Wall 1/8" Corrugated	14 x 22 CB	100	25	63.00 Net
* BAC-14	Backer Single Wall 1/8" Corrugated	12 x 14 CB	100	15	44.50 Net

No Discounts for Backer

* BOB-1	Bobber Silhouette 1/4" Chipboard	19 1/2 x 40 CH	100	200	430.00
* BOB-2	Bobber Silhouette 1/4" Double Wall Corrugated	19 1/2 x 40 CB	100	100	430.00
* BOB-3	Bobber Silh. 1/4" Double Wall Corrugated	19 1/2 x 34 1/2 CB	100	120	130.00
* FAC-1	Facer Silhouette	19 1/2 x 40 P	100	8	58.00
* PAS-BL S	Paster Black Square Pressure Sensitive	1 PSP	1000	1	7.80 Roll
* PAS-BL R	Paster Black Round Pressure Sensitive	3/4 PSP	1000	1	7.80 Roll
* PAS-WH S	Paster White Square Pressure Sensitive	1 PSP	1000	1	7.80 Roll
* PAS-WH R	Paster White Round Pressure Sensitive	3/4 PSP	1000	1	7.80 Roll
* PAS-BU S	Paster Buff Square Pressure Sensitive	1 PSP	1000	1	7.80 Roll
* PAS-BR S	Paster Brown Square Pressure Sensitive	1 PSP	1000	1	7.80 Roll
* PAS-BLUE S	Paster Blue Square Pressure Sensitive	1 PSP	1000	1	7.80 Roll
* PAS-GR S	Paster Blue Square Pressure Sensitive	1 PSP	1000	1	7.80 Roll
* PAS-RE R	Paster Red Round Pressure Sensitive	3/4 PSP	1000	1	7.80 Roll
* PAS-RE R2	Paster Red Round Pressure Sensitive	2 PSP	300	1	7.80 Roll

Discounts Apply

* SEE PAGE 51 FOR ADDITIONAL PASTERS

IPSC COMBAT TYPE SHOOTING TARGETS / IDPA TARGETS

* IPSC-CB	Official IPSC/USPSA Combat Target, Perforated Scoring, Buff one side (shoot), white one side (don't shoot). Corrugated Cardboard.	18 1/2 x 30 1/2 CB	100	44	66.00
* IPSC-P	Practice IPSC/USPSA Combat Target, Black Line Scoring White Target Paper.	20 x 32 P	200	20	40.00
* IPSC-P R	Reduced IPSC/USPA Practice Target	10 x 16 P	500	13	17.00
* BP-CB	RBowling Pin, Practice Target, White Corrugated Cardboard White Target Paper.	4 3/4 x 15 CB	100	18	36.00
* IDPA-CB	Official IDPA Combat Target, Perforated Scoring	18 1/4 x 31 CB	100	44	66.00
* IDPA-P	Official IDPA Training Target, Paper	21 1/2 x 34 P	200	20	40.00

Note "1": P = Paper / T = Tagboard / CB = 200 lb. cardboard / CH = Chipboard / PSP = Pressure Sensitive Paper / * Non NRA target

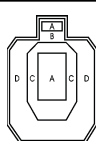

BP-CB

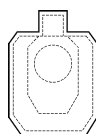

IDPA



1.800.243.8274 □ IN NJ 908.355.8600 □ FAX 908.355.1414

Speedwell™, the industry leader, manufactures more than 120 Steel Range Products for tactical training and combat type competition. Range products are available for shipment from stock or from the factory in 1 to 2 weeks.

Speedwell™ Steel Range products are designed and manufactured to stringent specification using selected raw materials and components to insure the highest quality products. Technical assistance is available at no cost for custom designed products to meet specific customer requirements. Custom products can be manufactured and shipped in 3 to 4 weeks.

Speedwell™ Steel Products are unconditionally guaranteed against defective material or workmanship for one year. They will be repaired or replaced at no cost.

Speedwell™ Reactive Steel Targets are available in 3 grades of ballistic grade steel plate.

Steel products designed **MS** are produced from steel plate with a Brinell Hardness (BHN) range of 200 – 325. **MS** Grade Steel is intended for light handgun or rimfire cartridge use. Only “all lead” light target ammunition for calibers .22 through .38 should be fired at **MS** Grade Steel. Jacketed or High Velocity service ammunition should not be fired at **MS** Grade Steel plate.

Steel products designed **HS** are produced from steel plate with a guaranteed minimum Brinell Hardness (BHN) of 400. **HS** Grade Steel Plate will withstand heavy use from handguns with factory service ammunition and shotgun shot shells without damage of the plate. Do not fire shotgun slugs or rifle ammunition at **HS** Grade Steel plate.

Steel products designated **RS** are produced from steel plate with a guaranteed Brinell Hardness (BHN) of 500 – 525. **RS** Grade Steel plate will withstand heavy use from handguns with service or special high-velocity police ammunition, rifles firing .223 Rem, .308 Win, and 30-06 ammunition, and shotgun slugs. Do not fire rifle ammunition or shotgun slugs at **RS** Grade Steel plates at less than 100 yards. Do not use armor piercing ammunition. ALL STEEL PLATES ARE 3/8" THICK UNLESS OTHERWISE NOTED.

Shooting at Steel Targets Can Be Hazardous. Jacketed service ammunition is particularly dangerous. When firing metallic ammunition (lead or jacketed), the shooter and observer distance to steel targets must be at least 25 yards. Steel targets may send bullet splatter back toward the firing line. EYE protection with side shields, EAR protection, long sleeved shirts and long pants must be worn by anyone within 75 yards of the steel targets.

Steel Reactive Targets are angled to deflect bullet fragments downward upon impact. When a Reactive Steel Target is hit while falling, very dangerous bullet ricochet or fragment splatter can be deflected back toward the shooter(s) or toward the ceiling in an indoor range.

The use of lead free composite (non-metallic) frangible ammunition which disintegrates upon impact and eliminates fragmentation and metallic splatter is strongly recommended for use with steel targets.

Extreme caution should be taken to position steel targets on the firing range(s) to minimize ricocheting of bullet fragments back to the firing line. Range Safety Rules must be strictly observed.

Since we cannot control the use of our steel products, we neither imply nor accept any liability for results of their use or misuse.

Please read and carefully observe the **Hazardous Warning** labels affixed to all **Speedwell™** Steel products.

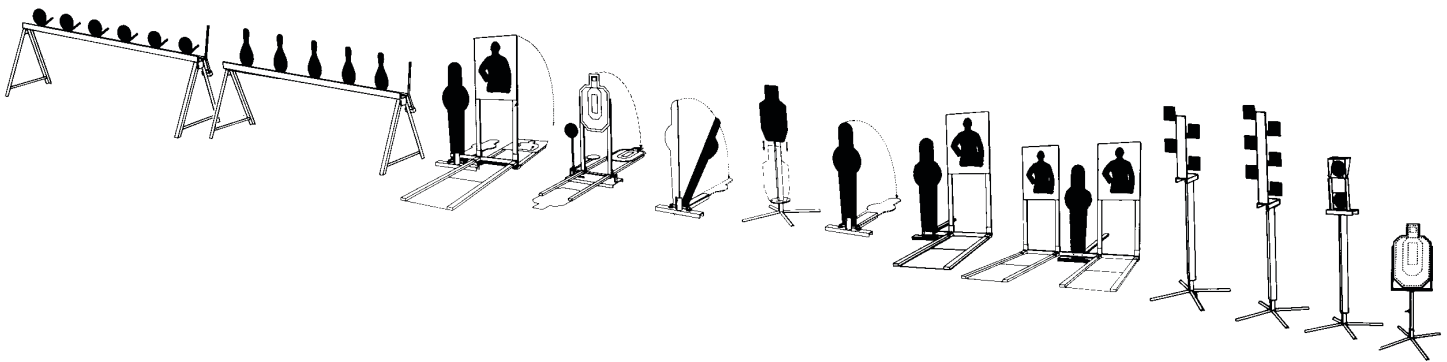

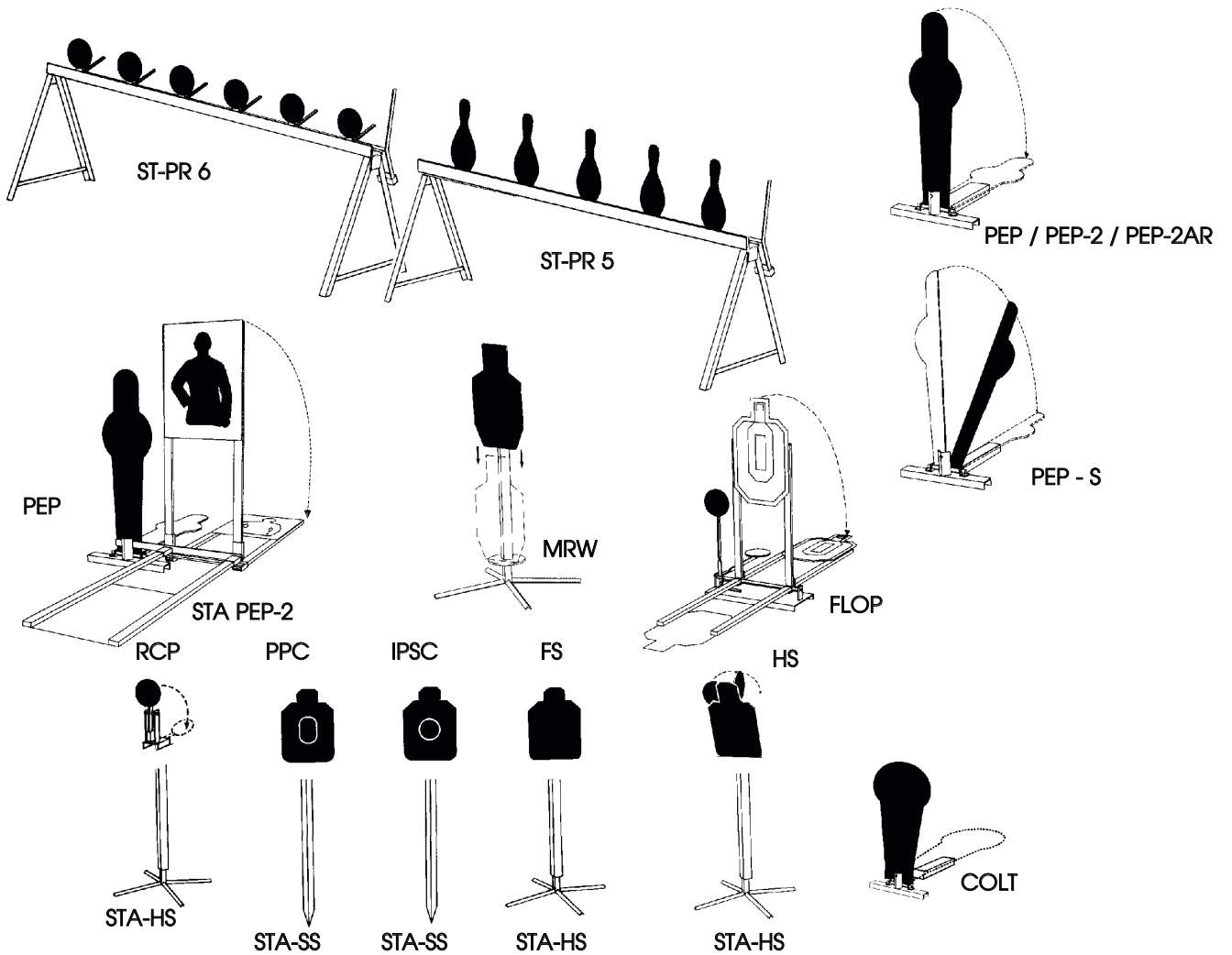

REACTIVE STEEL STANDS

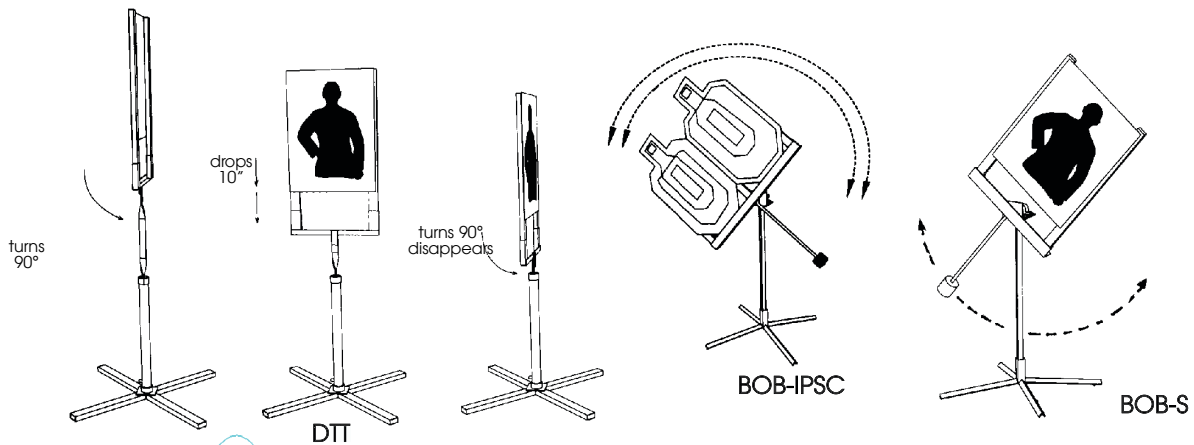

Reactive Steel Targets

TARGET NUMBER	DESCRIPTION	SIZE ¹ / STOCK	TARGETS PER CARTON	SHIPPING WEIGHT PER CARTON	LIST PRICE EACH
ST-PR 6	Steel Plate Rack 6" x 8" HS Round Steel Plates mounted on competition spec table 45" high x 10' long. Reset with single handle or remotely with pull cord. Optional Plate sizes available. Adjustable for Power Factor. HS		45" x 10'	250	\$1530.00
ST-PR 6R	Steel Plate Rack 6" x 8" RS Round Steel Plates mounted on competition spec table 45" high x 10' long. Reset with single handle or remotely with pull cord. Optional Plate sizes available. Adjustable for Power Factor. RS		45" x 10'	300	1790.00
ST-PR 5	Steel Plate Rack, 5 x HS Bowling Pin Plates. Same as above only table is 8' long. HS		45" x 8'	235	1428.00
BPH-AR	Auto-Reset Bowling Pin, HS		4 1/2" x 16"	25	190.00
PEP	Pepper Popper, IPSC, Reactive Silhouette Target, Fully adjustable for Power Factor, MS		12" x 42"	65	200.00
PEP-H	Pepper Popper, IPSC, Reactive Silhouette Target, Fully adjustable for Power Factor, HS		12" x 42"	65	240.00
PEP-R	Pepper Popper, IPSC, Reactive Silhouette Target, Fully adjustable for Power Factor, RS, Rifle		12" x 42"	65	350.00
PEP-S	Vertical Split Pepper Popper, Knock down each side independently, "Hostage or Shoot/Don't Shoot Scenarios" Adjustable for Power Factor, MS		12" x 42"	65	216.00
PEP-SH	Vertical Split Pepper Popper, HS		12" x 42"	65	282.00
PEP-SR	Vertical Split Pepper Popper, RS		12" x 42"	65	393.75
PEP-2	Mini Pepper Popper, same as PEP, 1/2" Size Adjustable for Power Factor, MS		6" x 21"	25	120.00
PEP-2H	Mini Pepper Popper, same as PEP, 1/2" Size, HS		6" x 21"	25	158.00
PEP-2HAR	Auto-Reset Pepper Popper, HS		4" x 14"	25	212.00
PEP-2R	Mini Pepper Popper, same as PEP, 1/2" Size, RS		6" x 21"	25	239.00
COLT	Colt Speed Plate Popper, Adjustable for Power Factor, 2/3 Size, MS		12" x 28"	55	152.00
COLT-H	Colt Speed Plate Popper, Adjustable for Power Factor, 2/3 Size, HS		12" x 28"	55	181.00
COLT-R	Colt Speed Plate Popper, Adjustable for Power Factor, 2/3 Size, RS		12" x 28"	55	275.00
MRW	MRW Dropper, IPSC A-B-C Zone Plate with Stand, Drops when Hit, MS		12" x 48"	65	202.00
MRW-H	MRW Dropper, IPSC A-B-C Zone Plate with Stand, Drops when Hit, HS		12" x 48"	65	246.00
MRW-R	MRW Dropper, IPSC A-B-C Zone Plate with Stand, Drops when Hit, RS		12" x 48"	65	365.00
FLOP	3-Way Flopper, 8" Steel Circle Plate and 2 IPSC or Police Silhouette Targets, Many "Shoot/Don't Shoot" options, MS		12" x 42"	50	178.00
FLOP-H	3-Way Flopper, 8" Steel Circle Plate and 2 IPSC or Police Silhouette Targets, Many "Shoot/Don't Shoot" options, HS		12" x 42"	50	205.00
FLOP-R	3-Way Flopper, 8" Steel Circle Plate and 2 IPSC or Police Silhouette Targets, Many "Shoot/Don't Shoot" options, RS		12" x 42"	50	210.00
RCP	Reactive Circle Plate, Automatic Re-set, removable 8" Plate, HS		8" x 24"	25	278.00
RCP-R	Reactive Circle Plate, Automatic Re-set, removable 8" Plate, RS		8" x 24"	25	419.00
PPC	Police Combat Silhouette Target, Head, Center Mass, Dual Shooting Option, 6" x 6" Head Plate, B-27 Center Plate, HS		12" x 24"	45	374.00
PPC-R	Police Combat Silhouette Target, Head, Center Mass, Dual Shooting Option, 6" x 6" Head Plate, B-27 Center Plate, RS		12" x 24"	45	571.00
IPSC	IPSC Combat Silhouette Target, Head, Center Mass, Dual Shooting Option, 6" x 6" Head Plate, 8" Center Plate, HS		12" x 24"	45	411.00
IPSC-R	IPSC Combat Silhouette Target, Head, Center Mass, Dual Shooting Option, 6" x 6" Head Plate, 8" Center Plate, RS		12" x 24"	45	587.00
FS	Fixed Combat Silhouette, Emits audible response when hit, HS		12" x 24"	35	375.00
FS-R	Fixed Combat Silhouette, Emits audible response when hit, RS		12" x 24"	35	564.00
HS	Tactical Hostage Silhouette, 2 Hostage Head Plates (One over each shoulder). Drop one, the other appears, HS		12" x 24"	52	588.00
HS-R	Tactical Hostage Silhouette, 2 Hostage Head Plates (One over each shoulder). Drop one, the other appears, RS		12" x 24"	50	677.00
BOB-S	Bobber Target Stand. Activated by counterweight pendulum, Mounted on ball bearings. Adjustable for speed and duration.		24" x 72"	40	352.00
BOB-IPSC	Swinger Target Stand. Holds 2 IPSC Targets. Counterweighted and mounted on ball bearings for long swing time.		38" x 72"	45	374.00
DTT	Drop-Turn Target Stand. Metered piston actuates target to appear and/or disappear. Accepts paper or cardboard targets. Can be actuated manually, by another target (i.e. Pepper Popper), or range prop. Adjustable speed control (1/2 to 8 seconds).		18" x 72"	35	490.00

Speed Plates/Dueling Trees Challenge Plates & Stands

New Product



SP-LP2

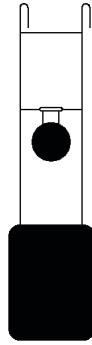

RCT

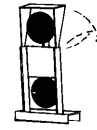

SSP-6 / STA-HS

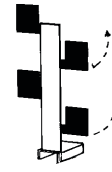

DT-4 / STA-DT

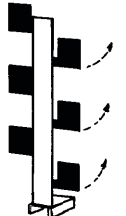

DT-6 / STA-DT

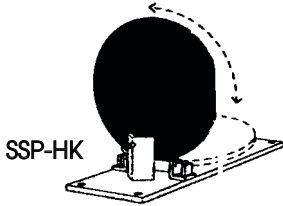

SSP-HK

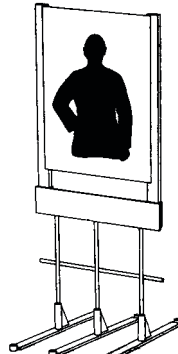

STA-HA
STA-H

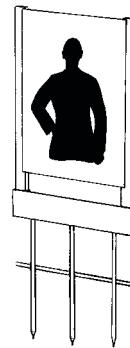

STA-SA
STA-S

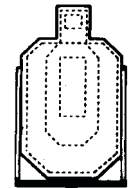

STA-IPSC

SP-8C

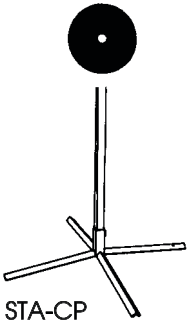

STA-CP

SP-RC

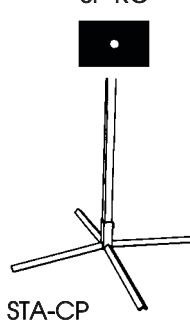

STA-CP



STA-LPA

SP-8

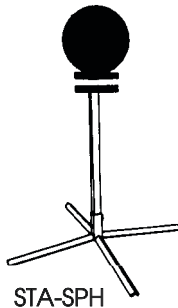

STA-SPH

PEP

STA-PEP 2

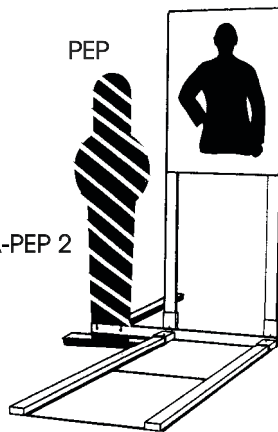

STA-PEP 4

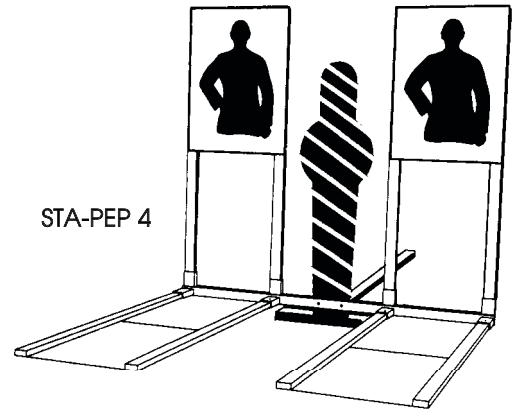

Steel Reactive Targets

TARGET NUMBER	DESCRIPTION	SIZE ¹ / STOCK	TARGETS PER CARTON	SHIPPING WEIGHT PER CARTON	LIST PRICE EACH
KNOCKDOWN SPEED PLATES					
SSP-HK10	Steel Speed Plate, 10" Round Plate w/Base, Auto Re-set, HS		10" x 12"	35	\$150.00
SSP-HK10R	Steel Speed Plate, 10" Round Plate w/Base, Auto Re-set, RS		10" x 12"	35	225.00
SSP-6	Steel Knockdown Speed Plate, 6" Round with Reactive Re-set Plate, MS		6" x 12"	35	365.00
SSP-6H	Steel Knockdown Speed Plate, 6" Round with Reactive Re-set Plate, HS		6" x 12"	40	440.00
SSP-6R	Steel Knockdown Speed Plate, 6" Round with Reactive Re-set Plate, RS		6" x 12"	40	689.00
STA-HS	Steel Target Stand		4'0"	36	136.25

SWINGING DUELLING TREES

DT-4	Steel Duelling Tree, 4 - 4" x 6", Swinging Plates, MS		16" x 28"	40	219.00
DT-4H	Steel Duelling Tree, 4 - 4" x 6", Swinging Plates, HS		16" x 28"	40	265.00
DT-4R	Steel Duelling Tree, 4 - 4" x 6", Swinging Plates, RS		16" x 28"	40	398.75
DT-6	Steel Duelling Tree, 6 - 4" x 6", Swinging Plates, MS		16" x 42"	55	295.00
DT-6H	Steel Duelling Tree, 6 - 4" x 6", Swinging Plates, HS		16" x 42"	55	378.00
DT-6R	Steel Duelling Tree, 6 - 4" x 6", Swinging Plates, RS		16" x 42"	55	566.00
SP-LP2	Steel Lolli Popper Rifle Target 2 - 8", Swinging Plates with Base RS		20" x 50"	35	300.00
STA-DT	Steel Duelling Tree Stand		3'0"	30	136.25
RCT-H	Reactive Steel Combat Target with 4" Spinning Failure Plate HS		29" x 9"	35	306.25
RCT-R	Reactive Steel Combat Target with 4" Spinning Failure Plate RS		29" x 9"	35	387.50

AUDIBLE RESPONSE CHALLENGE PLATES

SP-8C	Steel Challenge Plate, 8" Round, MS		8"	8	30.50
SP-8CH	Steel Challenge Plate, 8" Round, HS		8"	8	53.00
SP-8CR	Steel Challenge Plate, 8" Round, RS		8"	10	56.75
SP-10C	Steel Challenge Plate, 10" Round, MS		10"	12	34.00
SP-10CH	Steel Challenge Plate, 10" Round, HS		10"	12	57.00
SP-10CR	Steel Challenge Plate, 10" Round, RS		10"	13	60.75
SP-12C	Steel Challenge Plate, 12" Round, MS		12"	16	38.00
SP-12CH	Steel Challenge Plate, 12" Round, HS		12"	16	64.50
SP-12CR	Steel Challenge Plate, 12" Round, RS		12"	18	68.75
SP-RC	Steel Challenge Plate, 18" x 24" Rect, MS		18" x 24"	30	87.00
SP-RCH	Steel Challenge Plate, 18" x 24" Rect, HS		18" x 24"	30	147.50
SP-QCH	Steel Challenge Plate, 12" x 26", HS		12" x 26"	26	185.00
STA-CP	Steel Challenge Plate Stand		4'0"	22	75.00

Note: Other Steel Plates can be drilled and mounted on STA-CP, Steel Challenge Plate Stand.

TARGET STANDS

STA-S	Steel Target Range Stand, Stake, 18" center, Soft Ground		4'0"	22	89.00
STA-H	Steel Target Range Stand, Free Standing Base, 18" center, Hard Ground		4'0"	30	105.00
STA-SA	Steel Target Range Stand, Stake, adjustable for targets 20" to 45" wide, Soft Ground		4'0"	24	105.00
STA-HA	Steel Target Range Stand, Free Standing Base, adjustable for targets 20 to 45" wide, Hard Ground		4'0"	28	112.00
STA-IPSC	Portable Stand, Free Standing Base. Holds standard IPSC targets. 3' high		3'0"	27	75.00
STA-CP	Target Stand for SPEEDWELL™ Challenge Plates and Steel Silhouettes, mounting bolt and coil spring for enhanced hit sound		4'0"	24	75.00
STA-PEP 2	Paper Target Bracket, mounts on Pepper Popper, holds 2 targets, provides 3 shooting options		2'6"	13	102.00
STA-PEP 4	Paper Target Bracket, mounts on Pepper Popper, holds 4 targets, provides 5 shooting options		4'6"	20	150.00
STA-SS	Steel Target Stand, Stake, Soft Ground, for RCP, PPC, IPSC, FS, and HS Reactive Targets		4'6"	20	113.00
STA-HS	Steel Target Stand, Free Standing Base, Hard Ground, for RCP, PPC, IPSC, FS and HS Reactive Targets		4'0"	36	136.25
STA-SPS	Steel Target Stand for Single Steel Plate, Soft Ground		5'0"	26	68.00
STA-SPH	Steel Target Stand for Single Steel Plate, Hard Ground		5'0"	30	74.00
STA-LPA	Adjustable Steel Target Stand, adjust from 15 1/2" to 27 1/2", 4 stakes included. Accommodates 1" x 2" furring strips. Patent Pending.		18 x 17 x 7"	15	62.00
STA-LPS	Lightweight Portable Target Stand. Holds IPSC, IDPA, & D-1		14 x 20	16	62.00

Note *1": P = Paper / T = Tagboard / CB = 200 lb. cardboard / Non NRA target

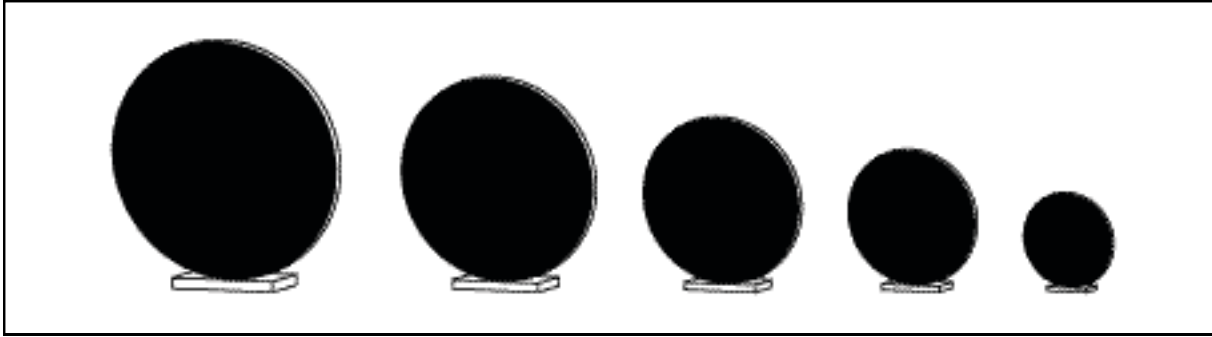

SP-12 / SP-10 / SP-8 / SP-6 / SP-4

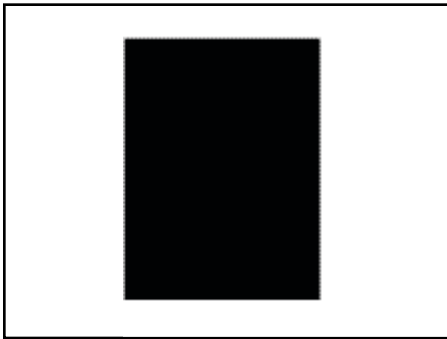

SP-R

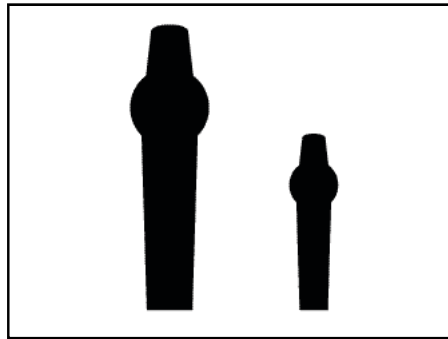

SP - PEP / SP - PEP 2

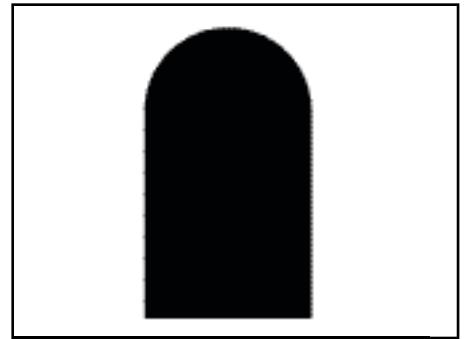

SP - D1 - D2

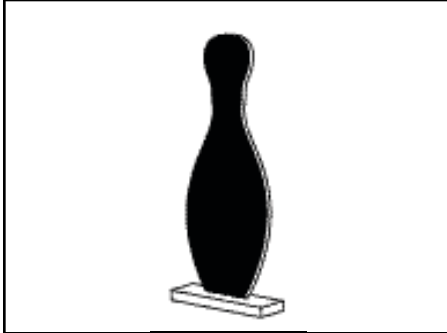

SP - BP

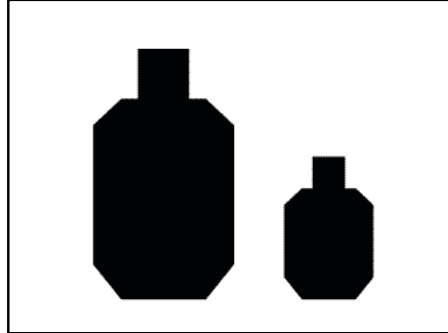

SP-IPSC / SP-IPSC2

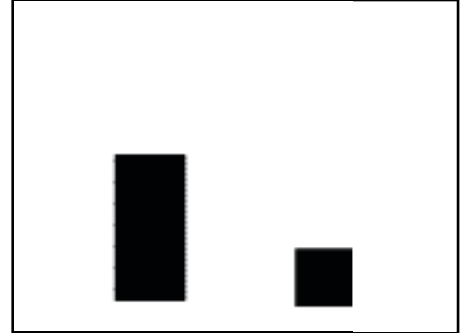

SP-IPSCA / SP-IPSCB

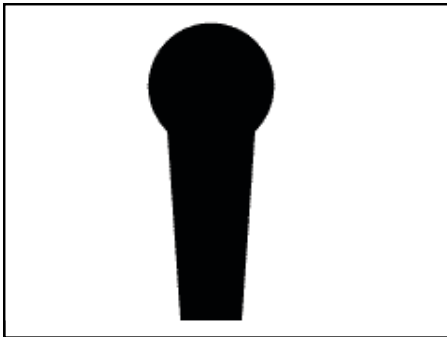

SP-NRA / SP-COLT



SP-Q

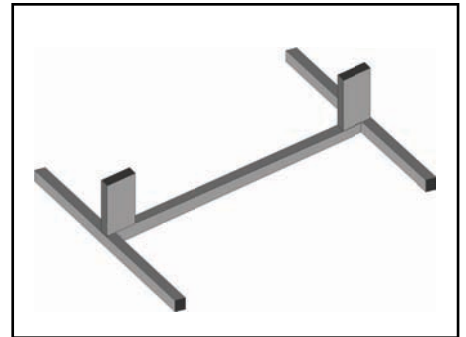

STA-LPS

Steel Plates

TARGET NUMBER	DESCRIPTION	SHIPPING WEIGHT PER CARTON	LIST PRICE EACH
SP-Q	Steel Plate, FBI "Q", 12" x 26", HS	24	\$182.00
SP-QR	Steel Plate, FBI "Q", 12" x 26", Each, Rifle, Shotgun, 1/2" RS	24	247.50
SP-4	Steel Plate, 4" Round w/Base, Set of 6, MS	15	141.25
SP-4H	Steel Plate, 4" Round w/Base, Set of 6, HS	15	260.00
SP-4R	Steel Plate, 4" Round w/Base, Each, Rifle, Shotgun, 1/2" RS	4	65.00
SP-6	Steel Plate, 6" Round w/Base, Set of 6, MS	28	145.00
SP-6H	Steel Plate, 6" Round w/Base, Set of 6, HS	28	252.00
SP-6R	Steel Plate, 6" Round w/Base, Each, Rifle, Shotgun, 1/2" RS	6	69.00
SP-8	Steel Plate, 8" Round w/Base, Set of 6, MS	42	170.00
SP-8H	Steel Plate, 8" Round w/Base, Set of 6, HS	42	298.75
SP-8R	Steel Plate, 8" Round w/Base, Each, Rifle, Shotgun, 1/2" RS	10	74.00
SP-10	Steel Plate, 10" Round w/Base, Each, MS	12	32.50
SP-10H	Steel Plate, 10" Round w/Base, Each, HS	12	55.00
SP-10R	Steel Plate, 10" Round w/Base, Each, Rifle, Shotgun, 1/2" RS	15	82.50
SP-12	Steel Plate, 12" Round w/Base, Each, MS	16	36.00
SP-12H	Steel Plate, 12" Round w/Base, Each, HS	16	61.25
SP-12R	Steel Plate, 12" Round w/Base, Each, Rifle, Shotgun, 1/2" RS	20	91.00
SP-BP	Steel Bowling Pin w/Base, Set of 5, MS	35	130.00
SP-BPH	Steel Bowling Pin w/Base, Set of 5, HS	35	258.25
SP-BPR	Steel Bowling Pin w/Base, Each, Rifle, Shotgun 1/2", RS	10	68.75
SP-IPSC	Steel Plate, IPSC Silhouette, 17 ³ / ₄ " x 29 ¹ / ₂ ", MS	55	113.50
SP-IPSCH	Steel Plate, IPSC Silhouette, 17 ³ / ₄ " x 29 ¹ / ₂ ", HS	55	197.00
SP-IPSCR	Steel Plate, IPSC Silhouette, 17 ³ / ₄ " x 29 ¹ / ₂ ", RS	55	295.00
SP-IPSC2	Steel Plate, IPSC Silhouette, 1/2 Size, 8 ³ / ₄ " x 14 ³ / ₄ ", MS	12	68.00
SP-IPSC2H	Steel Plate, IPSC Silhouette, 1/2 Size, 8 ³ / ₄ " x 14 ³ / ₄ ", HS	12	117.50
SP-IPSC2R	Steel Plate, IPSC Silhouette, 1/2 Size, 8 ³ / ₄ " x 14 ³ / ₄ ", RS	12	177.00
SP-IPSCA	Steel Plate, IPSC "A" Zone, 6" x 11", MS	8	47.50
SP-IPSCAH	Steel Plate, IPSC "A" Zone, 6" x 11", HS	8	78.75
SP-IPSCAR	Steel Plate, IPSC "A" Zone, 6" x 11", RS	8	117.50
SP-IPSCB	Steel Plate, IPSC "B" Zone, 6" x 6", MS	4	34.00
SP-IPSCBH	Steel Plate, IPSC "B" Zone, 6" x 6", HS	4	53.00
SP-IPSCBR	Steel Plate, IPSC "B" Zone, 6" x 6", RS	4	90.00
SP-R	Steel Plate, Rectangular, 18" x 24", MS	46	98.00
SP-RH	Steel Plate, Rectangular, 18" x 24", HS	46	170.00
SP-RR	Steel Plate, Rectangular, 18" x 24", RS	46	225.00
SP-PEP	Steel Plate, IPSC Silhouette, Popper, 12" x 42", MS	35	83.00
SP-PEPH	Steel Plate, IPSC Silhouette, Popper, 12" x 42", HS	35	150.00
SP-PEPR	Steel Plate, IPSC Silhouette, Popper, 12" x 42", RS	35	218.75
SP-PEP2	Steel Plate, IPSC Silhouette, Popper, 1/2 Size, 6" x 21", MS	22	52.00
SP-PEP2H	Steel Plate, IPSC Silhouette, Popper, 1/2 Size, 6" x 21", HS	22	90.00
SP-PEP2R	Steel Plate, IPSC Silhouette, Popper, 1/2 Size, 6" x 21", RS	22	136.75
SP-D1	Steel Plate, D-1 Bianchi, 18" x 30", MS	46	83.00
SP-D1H	Steel Plate, D-1 Bianchi, 18" x 30", HS	46	145.50
SP-D1R	Steel Plate, D-1 Bianchi, 18" x 30", RS	46	218.75
SP-D2	Steel Plate, D-2 Bianchi, 5" x 8.4", MS	5	24.00
SP-D2H	Steel Plate, D-2 Bianchi, 5" x 8.4", HS	5	42.00
SP-D2R	Steel Plate, D-2 Bianchi, 5" x 8.4", RS	5	62.00
SP-COLI	Steel Plate, COLI, (NRA Action Speed Plate), 4 ¹ / ₂ " x 12" x 28, MS	23	68.00
SP-COLIH	Steel Plate, COLI, (NRA Action Speed Plate), 4 ¹ / ₂ " x 12" x 28, HS	23	108.00
SP-COLIR	Steel Plate, COLI, (NRA Action Speed Plate), 4 ¹ / ₂ " x 12" x 28, RS	23	175.00

Note "2": All steel plates are 3/8" thick except where noted.

Gun Care "UltraClean™" Weapons Cleaning Systems

"A clean weapon may save your life—a dirty one may not"

Designed and manufactured for **Speedwell™** by the world's leading manufacturer of aqueous-based weapons cleaning systems. "UltraClean™" state-of-the-art water-based Ultrasonic cleaning/lubricating systems do not require conventional hazardous solvents.

Speedwell™ UltraClean™ Solutions are non-hazardous, safe, and virtually odorless which require only normal room ventilation.

Speedwell™ UltraClean™ Systems reduce downtime and are used by Law Enforcement agencies, Armories, Training Officers, Training facilities, Ranges and Security Firms.

Speedwell™ UltraClean™ Systems include the following: stainless steel tanks, stainless steel baskets, stainless steel lubricating pans, non-hazardous safety solutions, and an easy-to-read operations manual.

Speedwell™ UltraClean™ Systems meet ISO 9001 requirements.

Speedwell™ UltraClean™ units come with state-of-the-art transducers, automatic tuning, temperature control sensors, drains and timers.

UltraClean™ 650 Tactical Set-Up with Heat

Dimensions: 19³/₄" x 11³/₄" x 6¹/₂" Tank size



- UltraClean™ 650
- Timer and Heat
- Streamline Kit
- 2 Ga. Cleaning Solution
- 2 Ga. Lubricating Solution
- Covers and Drain Included

\$3560.00

UltraClean™ 420 with Heat

- 2 Ultraclean™ 210's with Heat

Dimensions: 11³/₄" x 6" x 6" Tank Size Each

- Timer and Heat
- 2 Baskets
- 2 Ga. Cleaning Solution
- 2 Ga. Lubricating Solution
- Covers and Drain Included

\$2320.00



Gun Care "Ultraclean™" Weapons Cleaning Systems



UltraClean™ 210 Set-Up with Heat

Dimensions: 11³/₄" x 6" x 6" Tank Size

- Timer and Heat
- Basket
- Auxiliary Lubricating Pan
- 1 Ga. Weapon Cleaning Solution
- 1 Ga. Weapon Lubricating Solution
- Covers and Drain Included

\$1360.00

UltraClean™ 36 with Heat

Dimensions: 36" x 6" x 8" Tank Size

- Digital Timer and Thermostatically Controlled Heater
- Weapon/Lubricating Rack
- Full Length Auxiliary Lubricating Pan and Cover
- 2 Ga. Weapon Cleaning Concentrate
- 4 Ga. Weapon Lubricating Solution
- Covers and Drain Included

\$7100.00



ULTRA CC – Non-hazardous Cleaning Concentrate

SW – 9 Lbs. \$73.00 / Gal.

ULTRA LS – Lubricating Solution

SW – 9 Lbs. \$68.95 / Gal.

ULTRA HCS – Optional Handcuff Clean & Disinfection Concentrate

SW – 2 Lbs. \$52.00 / 16 oz.

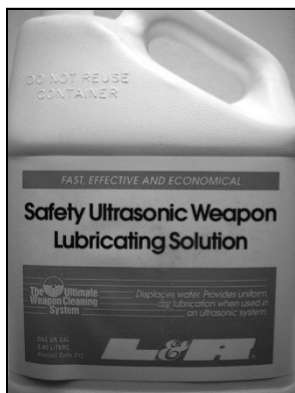
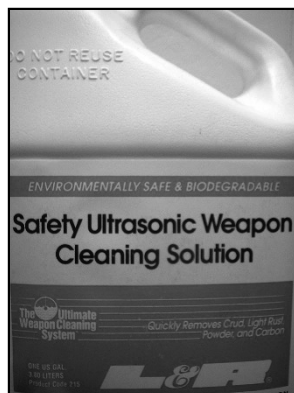

Professional Handgun Cleaning System

POWERED WITH ULTRASONICS

New Item



The Ultra-200 cleaning system offers the best cleaning & lubricating of handguns and revolvers available. Powered with Ultrasonic, the Ultra-200 reaches all surfaces of the handgun including those that are hard to access by hand.

- Designed for the recreational shooter, hobbyist, collector, sportsman.
- Cleans and lubricates in under 20 minutes.
- Comes complete with Ultra-200 cleaning & lubricating solutions, basket, lubricating pan, oiler, brush, cloth and more.
- ETL approved.
- Holds 1-6" Revolver or 2 full size Semi-Automatic Handguns.
- Tank internal dimension: 11.75" x 6" x 4"

Ultra-200 \$699.00



Speedwell Targets is an authorized dealer of Wiley-X eyewear. Wiley-X eyewear has a distinguished history that we are very proud of; shatterproof eye protection for Military, Law Enforcement, and Professional Sport Shooters Worldwide. All Wiley-X eyewear is constructed from nearly indestructible triloid nylon and the strongest die-cut, shatterproof polycarbonate lenses on the market today.

GL-SABER SHOOTER WRAPS

2.5mm optical quality shatterproof polycarbonate wrap around lens for increased field of vision and peripheral protection. Blocks 100% of harmful UV rays. Six base optical curve provides distortion free sight. Exceeds Mil-S-44366A Military standards for fragmentation. Lightweight felt brow, barrel screw hinge, comfortable nose piece, interchangeable paddle and cable ear pieces that are adjustable, soft case, leash cord. *Specify Color: Clear, Yellow, Amber, Slate, Vermilion*SW – 1 lb.
\$37.95

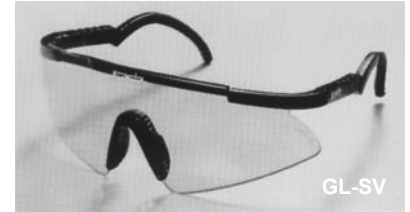

GL-ROMER II

2.0 mm optical quality shatterproof polycarbonate interchangeable lenses. Two, and three lens system are used for different times of day and light conditions. Technologically advanced triloid nylon frames are virtually unbreakable. Knob and 8 slot technology make changing of lenses hassle free. *Colors Include: Clear, Yellow, Slate.*
SW – 1 lb.
\$84.95

GL-AC: HI-IMPACT ECONOMY POLYCARBONATE

One piece with side shields. Designed to fit over prescription glasses. *Specify Color: Clear, Yellow, Slate, Vermilion.*
(Not Illustrated)
SW – 1 lb.
\$11.50

GL-NS: LOW LIGHT NIGHT STIMULATION GOGGLES

Formulated to function in bright overhead sun to cloudy overcast days. Transforms broad daylight into the shadowy, darkened conditions encountered in low light situations. *(Not Illustrated)*
SW – 1 lb.
\$22.50

TINT & APPLICATION

Clear: Indoor/Outdoor eye protection for those who prefer natural light. Provides clear protection from ultraviolet rays. Favorite of indoor pistol shooters. Ideal for industrial or professional use.

Yellow: Heighten Contrast. Brightens dimly lit areas. Ideal for cloudy, hazy weather conditions provides sharply improved visibility and contrast. Reduces glare for night driving. 100% UV Protection. Not recommended for use in bright sunlight.

Amber: Used to brighten and enhance target definition in all light conditions. Blocks all ultra-violet and blue light, the chief components of glare. The most versatile tint, effective for both outdoor and indoor shooting. Good for overcast weather and night driving. 100% UV Protection.

Slate: All purpose neutral tint. Transmits color evenly without changing light values. Does not impair vision. Provides greatest protection against glare. Popular in southwest. 100% UV Protection.

Vermillion: Enhance and improve detail and depth perception against blue and green backgrounds. First choice of Trap, Skeet and Sporting Clay enthusiasts. 100% UV Protection.

PENTAX "DCF" HIGH RESOLUTION BINOCULARS

Newly designed high resolution roof prism optics, streamlined, lightweight, wide aperture, long eye relief for easy viewing through glasses or sunglasses. Superb multicoating to reduce glare and prevent light from escaping. Special click-stop diopter setting means that your preset focusing adjustments remains securely in place — always. Rubber covered exterior finish with weatherproof and fogproof construction. Limited lifetime warranty. These are superb binoculars, superior to most brands priced much higher.

BIN-8DCF	Binoculars, 8 x 42 DCF HR with Case	Wt. 26 oz. \$455.75
BIN-10DCF	Binoculars, 10 x 42 DCF HR with Case	Wt. 26 oz. 519.25

PENTAX "UCF" COMPACT WEATHERPROOF BINOCULARS

Newly designed dual axis, single body housing with synchronized eye piece adjustment. For all weather conditions without fogging. Central fingertip control. Inverted porro prism designed for lightweight compact design. Widest view of field. Limited lifetime warranty.

BIN-8UCF	Binoculars, 8 x 24 UCF WR Synchronized Adjustment	Wt. 9.9 oz. \$190.75
BIN-10 UCF	Binoculars, 10 x 24 UCF WR Synchronized Adjustment	Wt. 9.9 oz. 211.95

BUSHNELL SPACEMASTER® WATERPROOF ARMORED SPOTTING SCOPE

15 x 45x Zoom Spacemaster® Spotting Scope, black rubber armored, interchangeable 15-45x zoom, 18mm, 20-45x long eye relief (LER) eyepiece. Designed to withstand demanding field conditions. Ruggedly built, featuring internal flare shielding, color corrected fully hard coated optics, complete with tripod and carrying case. Can be converted for telephotography.

SS-1545 B	Spotting Scope, 15 x 45 Zoom 60 mm Black Armored with tripod & case	Wt. 5 lb. \$466.25
SS-WM	Spotting Scope – Window Mount 15/16" (22mm) Black	Wt. 2 lb. 36.95

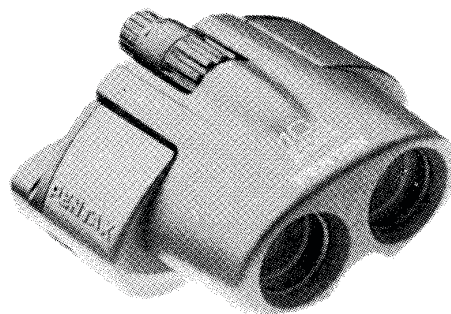

BIN-8UCF BIN-10UCF



SS-1545 B

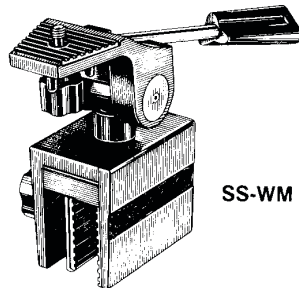

SS-WM

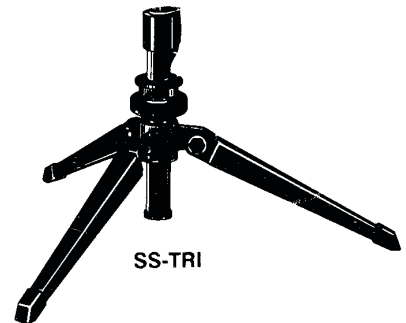

SS-TRI

Hearing Protection

Gun reports assault the ears and gradually cause damage that leads to permanent loss of hearing. Proper hearing protection will eliminate flinching, improve concentration and scores.

It is absolutely essential that hearing protection be worn on or near firing lines. Keep it quiet on the firing line with the finest quality hearing protection on the market.

These SILENCIO products have been especially selected to provide law enforcement personnel the very best hearing protection available.

To insure maximum protection, it is strongly recommended that earplugs be worn with earmuffs.

EARPLUGS

MDD-02	Disposable Soft Foam Plug. 200 Wrapped pairs in Display Box. NRR-29	.1 lb.	38.95
SDI-100	Soft vinyl earplug containing an air cushion for maximum comfort and protection against harmful impulse noise. (NRR-26)	.1 lb.	4.20

EARMUFFS

RBW-71	Economical and durable Earmuff with spring steel headband to allow 3-position use (overhead, behind head, under chin). Cups individually adjustable with foam filled ear cushions. (NRR-25 OH) Blue or Orange	1 lb.	\$ 17.95
CDS-80	Magnum Deluxe Earmuff, fully adjustable comfortable foam head pad, liquid-filled ear cushions to provide exceptional protection and comfort. (NRR-29) Black	1 lb.	37.95
Falcon	Rangesafe Monaural electronic hearing protector with 2 speakers. On/off switch with volume control and automatic shutdown at 82db. Designed for indoor/outdoor range and competition shooting. Black	1 lb.	142.95

RANGE CAPS

Finest Quality Poplin Cap – Embroidered



- Full Cut Featuring a High Crown.
- One Piece Stiff Front Construction
- 100% Cotton Sweatband, Non-Reflective Undervisor.
- Adjustable Size Slide Tab
- One Size Fits All

Colors

- Navy Blue with Gold Embroidery
- Red with Black Embroidery
- Black with Silver Embroidery
- Gold with Black Embroidery

Specify:

“Rangemaster” or “Firearms Instructor”

\$14.95 Each



PRO-4: PRO-TIMER IV SUPER – BEST COMPETITION MODEL



Time is only half and data needed to find out who won. You must have your score divided by time to get your HIT FACTOR. With the Pro-Timer IV Super, you enter your maximum stage points once. You then only need to enter your points down to get your HIT FACTOR. Nothing

could be simpler. Now you can compare your final score (HIT FACTOR) with you shooting buddy to find out who is really the best. It is also great for club matches since the final stage score is computed instantly.

Now with 3 Modes of Operation:

- Simplified Mode - Displays time, shot no, split time, start delay, par time & par no for Club Matches.
- Standard Mode - Displays time, shot no, split time, review time, review shot no & review split time for individual practice.
- Extended Mode - Same as standard mode plus runs multiple par times for cadence practice.

Other features:

- Automatic power down after 10 minutes of non use.
- Power down memory of up to 6 par times
- Selection of instant, random or settable fixed start delay.
- Plate input jack
- Remote start jack
- Relay driver jack
- Shot sensing sensitivity adjustment
- Horn on/off switch

SW – 2 lbs.

\$252.50

PRO-PR

Thermal Printer for use with the Pro-Timer IV. Infrared remote signal from PRO-IV activates unit to print shot string. PRO-IV screen displays printing data while transmitting to printer.

SW – 2 lbs.

\$198.50

PRO-C: PRO-CHRONO PLUS – BEST BULLET VELOCITY MEASUREMENT



A highly accurate, easily used portable chronograph utilizing ambient light-driven shadow sensors (Sky Screens) to activate a remote electronic counter.

- Largest Shooting Area
- 50 Shot Review
- Power Down Memory
- Greatest Velocity Range
- Extreme Spread
- Printer Interface
- Remote Jack

SW – 8 lbs.

\$129.95

PRO-P: PRO-TIMER P – COMPACT POCKET TIME



- Review four shot at a time with shot numbers, times & splits.
- 3 types of main screens selectable
 - a. Old Pocket Pro emulation (single number).
 - b. Shot time with shot number, split, 1st shot time, start delay type, time & date & battery condition.
 - c. Shot time with shot number, partime, 1st shot time, start delay type, time & date & battery condition.
- Review directly or set par time directly with up/down buttons.
- Set shot dead time to eliminate echos.
- Digital shot sensitivity adjustment.
- Random start delay minimum and maximums are settable between .5 & 9.9 seconds. Default is minimum 1 sec and maximum of 4 seconds per USPSA. Setting min. and Max. the same gives a fixed start delay.

\$176.95



Premium quality Gun Care products properly used may just save a life. These HOPPE products have been specially selected to insure the very best weapons maintenance and storage possible.

FAMOUS NO. 9 NITRO POWDER SOLVENT

The most universally used solvent for removing primer, powder, lead, and metal fouling. Prevents rust, flows freely, and penetrates rapidly

HOP-904 4 oz. bottle \$5.75 HOP-916 Pint \$14.00

BENCH REST NO. 9 COPPER SOLVENT

Cleans gun bores of copper fouling overnight, instead of 3-4 days. Powerful, safe, fast, and contains no abrasives. Also removes powder, lead, and plastic foulings from all handguns and shotguns.

HOP-BR-904 4 oz. bottle \$8.25 HOP-BR-916 Pint \$26.25

MDL

Moisture Displacing Lubricant. Drives out moisture, cleans, lubricates, protects and prevents corrosion. Prevents damage from moisture, salt, and friction. Ideal for after gun use.

HOP-MDL Aerosol Can \$5.50

LUBRICATING GUN OIL

High viscosity oil refined for use in firearms. Does not harden, gum, or become rancid. Extra long service.

HOP-1003 2-1/4 oz. \$2.75 HOP-1016 Pint \$10.25

SILICONE GUN CLEANING CLOTH

Flannel cloth treated to remove fingerprints and corrosive oils while polishing and coating gun surfaces with protective finish.

HOP-1218 Silicone Gun Cloth \$3.50

HANDGUN CLEANING KIT

Contains aluminum handgun rod, No. 9 solvent, lubricating oil, patches, knob ends, and brushes

HOP-PCO Calibers 9MM, 10MM, 38, 357, 40MM, 45 \$19.25

RIFLE CLEANING KIT

Contains aluminum rifle rod, No. 9 solvent, lubricating oil, patches, knob and slotted ends, and brushes

HOP-U22 Calibers 223, 308, 30-06, 9MM \$19.25

SHOTGUN CLEANING KIT

Contains aluminum shotgun rod, slotted end, No. 9 solvent, lubricating oil, patches, accessory adapter, and brush.

HOP-SGO12 All Gauges \$19.25

SHOTGUN CLEANING KIT

12 Gauge Washable "Fleece" Cleaning rod with oiling bob/case. One minute shotgun care.

STT-01 One piece with oiling bob \$17.25

DELUXE WOODEN PRESENTATION KIT

Contains 3 piece brass rod, 4 slotted ends and 5 phosphor bronze brushes to fit all caliber rifles, handguns, 12 and 20 gauge shotguns, No. 9 solvent, lubricating oil, patches, a rifle/shotgun adapter, handgun adapter, silicone cleaning cloth, a copy of "Guide to Gun Care", all fitted into a handsome presentation box.

HOP-BUOX Deluxe Presentation Kit \$68.75

NRA Pistol Targets

PRICES ARE PER 100 TARGETS.

PAGE 38



B-2

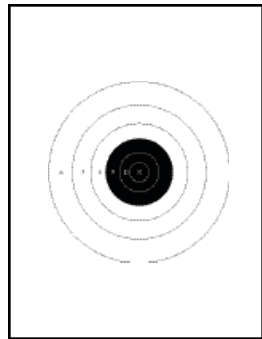

B-3



B-4 / B-5



B-6



B-8

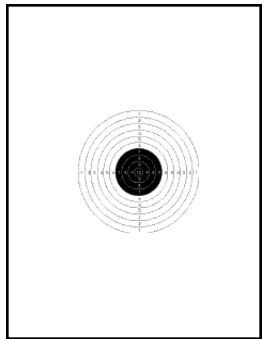

B-11

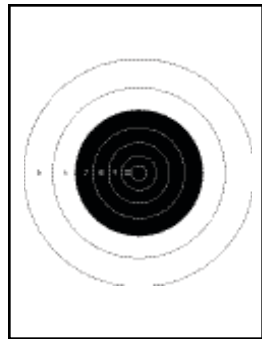

B-16



B-17 / B-19

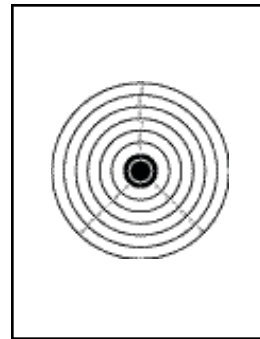

B-22

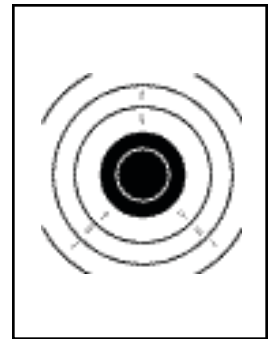

B-23



B-33



B-35



B-37 / B-38 / B-39



B-40

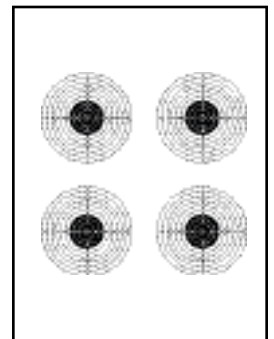

B-40 / 4

NRA ACTION PISTOL TARGETS

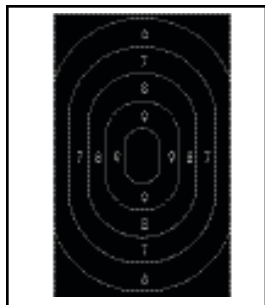

B-18



B-24

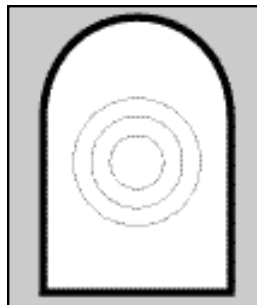

D-1 / D-2

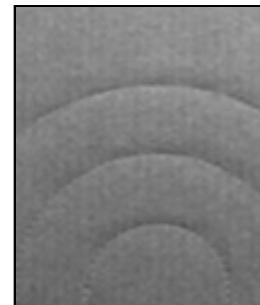

D-1 CB



1.800.243.8274 □ IN NJ 908.355.8600 □ FAX 908.355.1414

NRA Pistol Targets

PRICES ARE PER 100 TARGETS.

PAGE 39

TARGET NUMBER		DESCRIPTION	SIZE ¹ / STOCK		TARGETS PER CARTON	SHIPPING WEIGHT PER CARTON	LIST PRICE PER 100
B-2	50 FT	Slow Fire, Indoor Gallery	10 ¹ / ₂ x 12	T	1000	32	\$11.00
B-3	50 FT	Timed & Rapid Fire, Indoor Gallery	10 ¹ / ₂ x 12	T	1000	32	11.00
B-4	20 YD	Slow Fire	10 ¹ / ₂ x 12	T	1000	32	11.00
B-5	20 YD	Timed & Rapid Fire	10 ¹ / ₂ x 12	T	1000	32	11.00
B-6 P	50 YD	Slow Fire, NRA American Standard	21 x 24	P	500	35	22.25
B-6 T	50 YD	Slow Fire, NRA Statistical Scoring	21 x 24	T	250	35	54.40
B-6 CP	50 YD	Repair Center for B-6P	10 ¹ / ₂ x 10 ¹ / ₂	P	1000	15	6.50
B-6 CT	50 YD	Repair Center for B-6T	10 ¹ / ₂ x 10 ¹ / ₂	T	1000	38	11.00
B-8 P	25 YD	Timed & Rapid Fire, Competition	21 x 24	P	500	35	22.25
B-8 T	25 YD	Timed & Rapid Fire, Competition	21 x 24	T	250	35	54.40
B-8 CP	25 YD	Repair Center for B-8P	10 ¹ / ₂ x 10 ¹ / ₂	P	1000	15	6.50
B-8 CT	25 YD	Repair Center for B-8T	10 ¹ / ₂ x 10 ¹ / ₂	T	1000	38	11.00
B-11	50 FT	Slow Fire, Reduced International 50 M B-17	10 ¹ / ₂ x 12	T	1000	32	11.00
B-16	25 YD	25 YD Slow Fire, UIT	10 ¹ / ₂ x 12	T	1000	32	11.00
B-17	50 M	Slow Fire, UIT Free Pistol Precision, UIT	21 x 24	T	250	35	54.40
B-17 C	50 M	Repair Center for B-17, UIT	10 ¹ / ₂ x 10 ¹ / ₂	T	1000	30	11.00
B-19	50 YD	Slow Fire, Reduced 50 M B-17, UIT	21 x 24	T	250	35	54.40
B-19 C	50 YD	Repair Center for B-19 (Reduced B-17), UIT	10 ¹ / ₂ x 10 ¹ / ₂	T	1000	30	11.00
B-22	25 YD	Army "L"	28 x 28	P	200	20	38.50
B-23	25 YD	Repair Center for B-22	14 x 14	P	1000	30	10.00
B-33	50 FT	International Center Fire, Reduced 25M, UIT	14 x 14	T	500	24	19.50
B-35	25 YD	Reduced 50 M B-17 for Free Pistol, UIT	10 ¹ / ₂ x 12	T	1000	32	11.00
B-37	25 M	Rapid Fire, UIT	21 x 24	P	250	18	22.25
B-37 C	25 M	Repair Center for B-37, UIT	10 ¹ / ₂ x 10 ¹ / ₂	P	500	8	6.50
B-38	25 YD	Reduced 25M B-37, UIT	21 x 24	T	250	35	54.40
B-38 C	25 YD	Repair Center for B-38, UIT	10 ¹ / ₂ x 10 ¹ / ₂	T	1000	30	11.00
B-39	50 FT	Rapid Fire, Reduced 25M B-37, UIT	14 x 14	T	250	12	19.50
B-40	10 M	Air Pistol (33 FT), Single Bull, UIT	7 x 8	T	1000	13	6.00
B-40/4	10 M	Air Pistol (33 FT), 4 Bulls, UIT	14 x 14	T	500	24	19.50

NRA ACTION PISTOL TARGETS

* B-18	50 YD	Rapid Fire Silhouette	18 ¹ / ₂ x 32	P	200	16	36.75
B-18 C		Repair Center for B-18	17 ¹ / ₂ x 22	T	500	13	22.25
B-24	50 FT	50 YD Reduced B-18	12 x 20	T	250	24	26.25
D-1	7, 10, 15,	NRA Precision Target Events, Bianchi Type 20, 25 & 35 YD	23 x 35	T	200	20	61.00
D-1 CB	7, 10, 15,	NRA Precision Target Events, Bianchi Type 20, 25 & 35 YD	18 x 30	CB	100	44	66.00
D-1 C		Repair Center for D-1 Bianchi Target	10 x 10	T	1000	15	10.50
D-2	50 FT	Reduced 25 YD D-1 Bianchi Target	10 ¹ / ₂ x 12	T	1000	18	11.00

Note *1*: P = Paper / T = Tagboard / CB = 200 lb. cardboard / * Non NRA target

1.800.243.8274 □ IN NJ 908.355.8600 □ FAX 908.355.1414



NRA Training & Qualification Targets

PRICES ARE PER 100 TARGETS.

PAGE 40

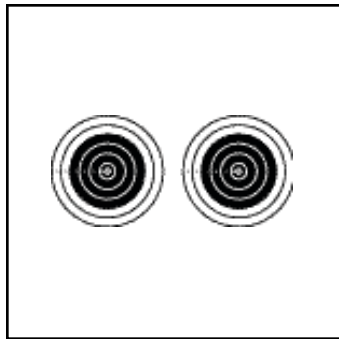

TQ-3/2

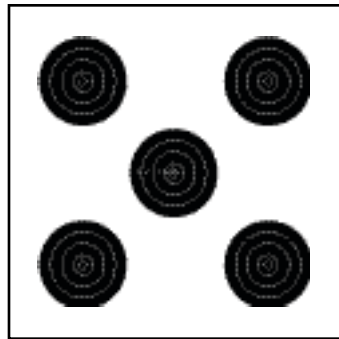

TQ-3/5

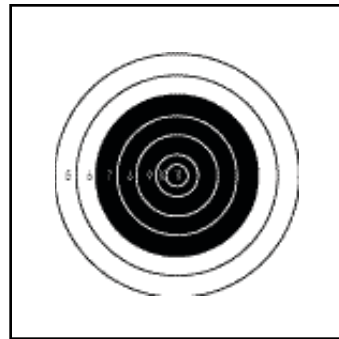

TQ-4

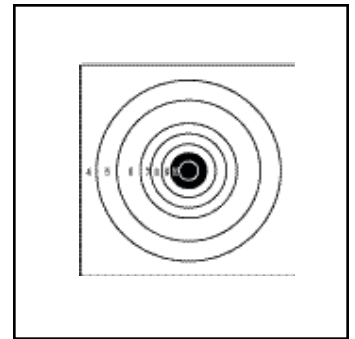

TQ-5/1

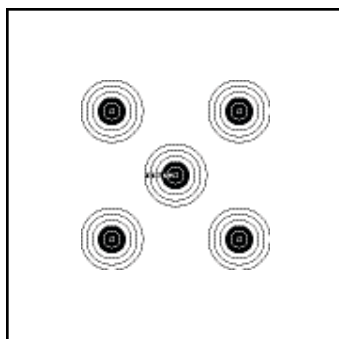

TQ-5/5

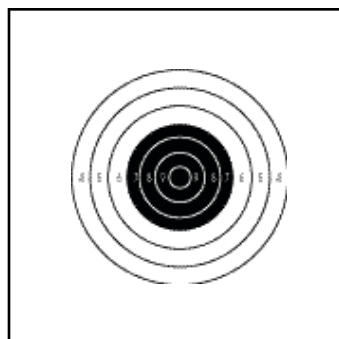

TQ-6

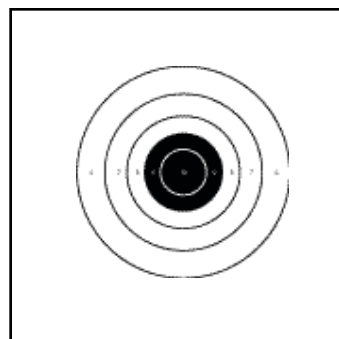

TQ-7



TQ-8

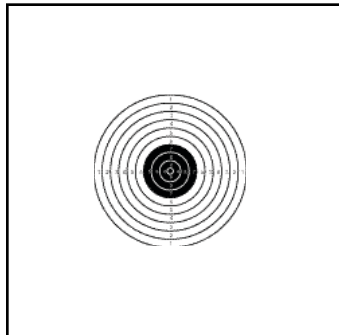

TQ-9

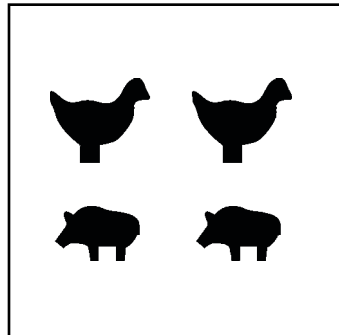

TQ-12

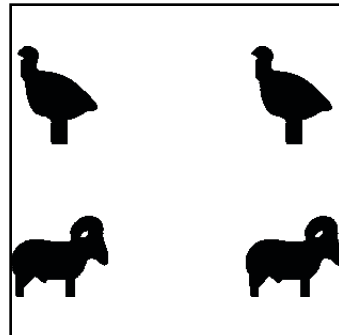

TQ-13

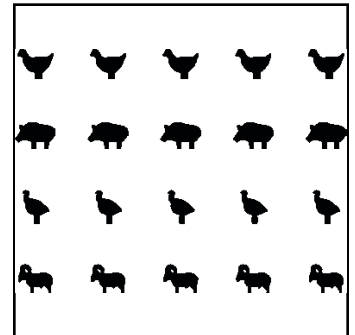

TQ-14

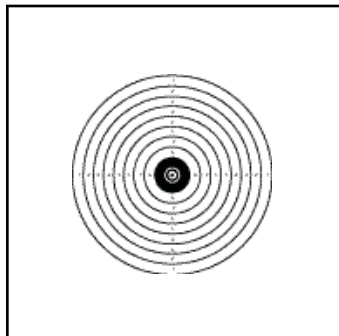

TQ-18

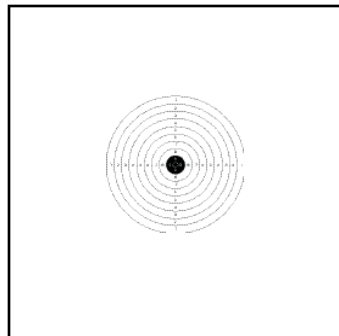

TQ-40



NRA Training & Qualification Targets

PRICES ARE PER 100 TARGETS.

PAGE 41

TARGET NUMBER		DESCRIPTION	SIZE ¹ / STOCK	TARGETS PER CARTON	SHIPPING WEIGHT PER CARTON	LIST PRICE PER 100
TQ-1/1 P	50 FT	Junior Rifle, Single Bull (same Bull as A-17)	7 x 9 P	1000	10	\$ 3.50
TQ-1/1 T	50 FT	Junior Rifle, Single Bull (same Bull as A-17)	7 x 9 T	1000	15	5.25
TQ-1/5 P	50 FT	Rifle, 5 Bulls (same Bull as A-17)	7 x 9 P	1000	10	3.50
TQ-1/5 T	50 FT	Rifle, 5 Bulls Distinguished Marksman (same Bull as A-17)	7 x 9 T	1000	15	5.25
TQ-2	75 FT	Rifle, Single Bull (same Bull as A-17)	4 x 6 T	1000	8	3.00
TQ-3/1	50 YD	Small Bore, Single Bull (same Bull as A-23)	7 x 9 P	1000	10	3.50
TQ-3/2 P	50 YD	Small Bore, 2 Bulls (same Bull as A-23)	9 x 14 P	1000	10	6.50
TQ-3/2 T	50 YD	Small Bore, 2 Bulls (same Bull as A-23)	9 x 14 T	500	18	12.25
TQ-3/5	50 YD	Small Bore, 5 Bulls (same Bull as A-23)	14 x 14 P	1000	30	9.75
TQ-4 P	100 YD	Small Bore, Single Bull (same Bull as A-25)	14 x 14 P	1000	30	9.75
TQ-4 T	100 YD	Small Bore, Single Bull (same Bull as A-25)	14 x 14 T	500	32	20.00
TQ-5/1	25 FT	Air Rifle, Single Bull	7 x 9 P	1000	10	3.50
TQ-5/5	25 FT	Air Rifle, 5 Bulls	7 x 9 P	1000	10	3.50
TQ-6	25 FT	Pistol, Slow Fire	5 x 6 T	1000	9	4.50
TQ-7	25 FT	Pistol, Timed & Rapid Fire	5 x 6 T	1000	9	4.50
TQ-8	25 FT	Air Pistol, UIT Rapid Fire, Reduced 25M, B-18	8 1/2 x 12 T	1000	32	12.50
TQ-9	25 FT	UIT, Slow Fire Pistol, Reduced 50M, B-17	6 x 9 T	1000	15	4.50
TQ-12	50 FT	Pistol Silhouette – 4 Bulls, (2 Chickens / 2 Pigs)	10 1/2 x 12 T	250	8	11.00
TQ-13	50 FT	Pistol Silhouette – 4 Bulls, (2 Turkey / 2 Rams)	10 1/2 x 12 T	250	8	11.00
TQ-14	50 FT	Rifle Silhouette – 20 Bulls, (5 Chickens / 5 Pigs / 5 Turkeys / 5 Rams)	10 1/2 x 12 T	250	8	11.00
TQ-17	25 YD	Same as B-8 without Scoring Rings	21 x 24 P	500	35	21.00
TQ-18	10 M	Air Rifle Training	7 x 8 T	1000	13	5.25
TQ-36	50 FT	Junior Rifle Practice, Single Bull using A-36 Scoring Rings	7 x 9 P	1000	10	3.50
TQ-39	50 FT	Junior Rifle, Practice	14 x 24 T	250	20	32.50
TQ-40	5M	BB Gun Experimental Target	7 x 9 T	1000	13	5.50

Note *1*: P = Paper / T = Tagboard / * Non NRA target

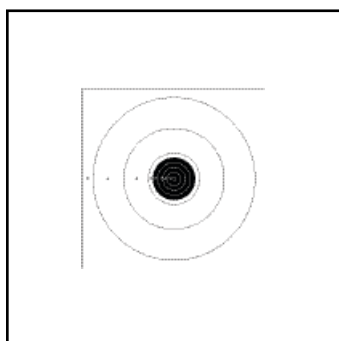

TQ-1/1

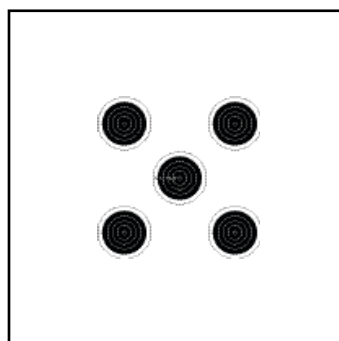

TQ-1/5

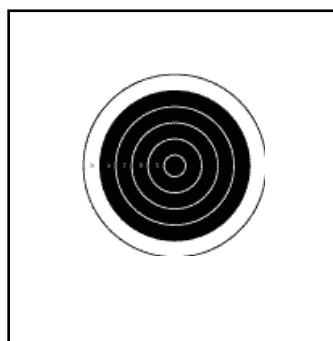

TQ-2

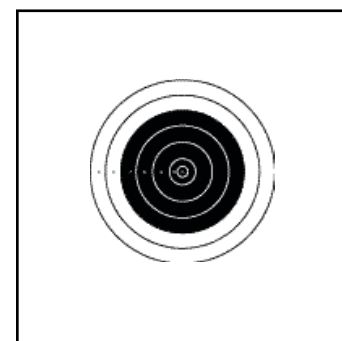

TQ-3/1

NRA Small Bore Rifle Targets

PRICES ARE PER 100 TARGETS.

PAGE 42

NRA SMALL BORE RIFLE TARGETS

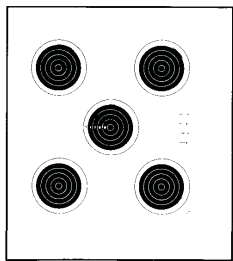

A-7/5

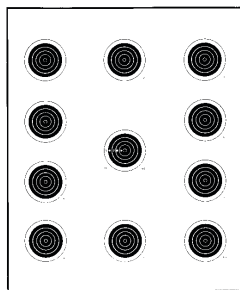

A-17

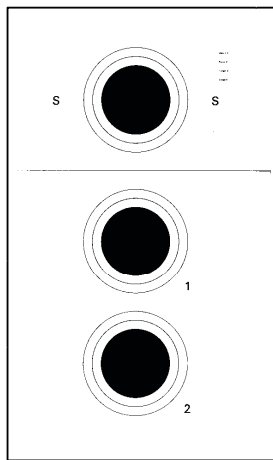

A-23/3 A-23/5

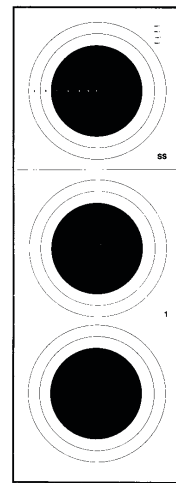

A-25

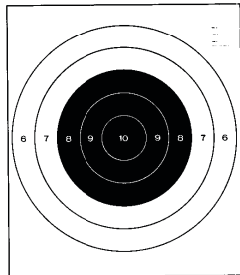

A-21

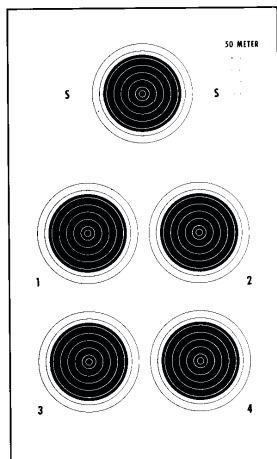

A-26

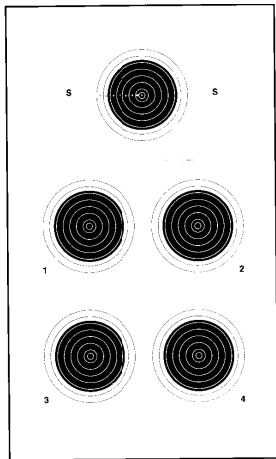

A-27

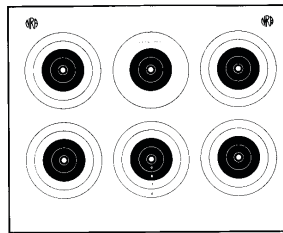

A-32

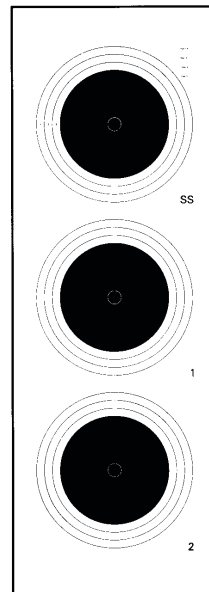

A-33

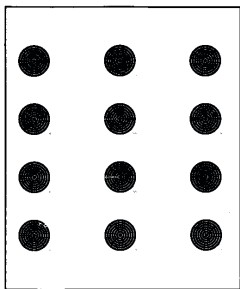

A-36

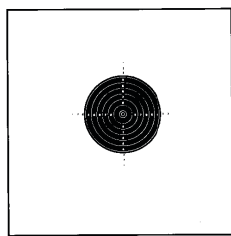

A-50/1

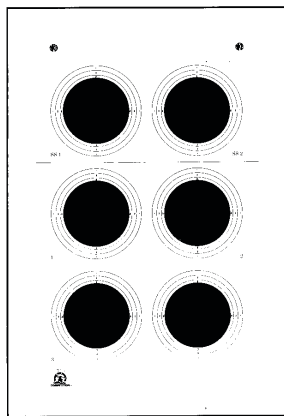

USA-50

A-50

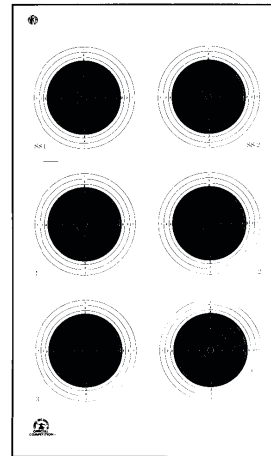

A-51



NRA Small Bore Rifle Targets

PRICES ARE PER 100 TARGETS.

PAGE 43

TARGET NUMBER		DESCRIPTION	SIZE ¹ / STOCK	TARGETS PER CARTON	SHIPPING WEIGHT PER CARTON	LIST PRICE PER 100
A-7/5	75 FT	Small Bore, 5 Bulls, (1 Sighter, 4 Record)	10 ¹ / ₂ x 12 T	1000	32	\$11.00
A-7/10	75 FT	Small Bore, 10 Bulls, (1 Sighter, 9 Record)	12 x 16 T	500	21	25.50
A-17	50 FT	Small Bore, 11 Bulls, (1 Sighter, 10 Record) Conventional 4 Position	10 ¹ / ₂ x 12 T	1000	32	11.00
A-17 G	50 FT	Small Bore, 11 Bulls, (1 Sighter, 10 Record) Conventional 4 Position, Orange Center	10 ¹ / ₂ x 12 T	1000	32	12.00
A-21	200 YD	Small Bore (Decimal), Single Bull, Conventional Prone	21 x 24 P	200	18	45.50
A-21 C		Repair Center for A-21	14 x 14 P	1000	30	9.75
A-23/3	50 YD	Tournament, Top Sighter, 3 Bulls (1 Sighter, 2 Record)	14 x 24 T	250	20	32.00
A-23/3 G	50 YD	Tournament, Top Sighter, 3 Bulls (1 Sighter, 2 Record) Orange Center	10 x 20 T	500	20	33.00
A-23/5	50 YD	Tournament, Top Sighter, 5 Bulls (1 Sighter, 4 Record) Conventional 4 Position	14 x 24 T	250	20	32.00
A-25	100 YD	Tournament, Top Sighter, 3 Bulls (1 Sighter, 2 Record)	14 x 42 T	100	18	56.50
A-26	50 M	Tournament, Top Sighter, 5 Bulls (1 Sighter, 4 Record) Conventional Prone, UIT	14 x 24 T	250	20	32.00
A-27	50 YD	Reduced International 50 M, 5 Bulls (1 Sighter, 4 Record) Conventional Prone, UIT	14 x 24 T	250	20	32.00
A-32	50 FT	.22 Caliber, 6 Bulls (1 Sighter, 5 Record)	9 ¹ / ₂ x 12 T	1000	32	11.00
A-33	100 YD	Reduced 300 M UIT, 3 Bulls (1 Sighter, 2 Record) Metric Prone	14 x 42 P	100	10	56.50
A-36	50 FT	12 Bulls (2 Sighters, 10 Record) NRA & International, 3 Position	10 ¹ / ₂ x 12 T	1000	32	11.00
A-50/1	50 M	UIT Top Sighter, 1 Bull, NRA & International 3 Position, English Match & Metric, Prone	14 x 24 T	250	20	32.00
A-50	50 M	UIT Top Sighter, 6 Bulls, (2 Sighters, 4 Record) NRA & International, 3 Position, English Match & Metric, Prone	14 x 24 T	250	20	32.00
A-51	50 YD	Reduced 50 M, 6 Bulls (2 Sighters, 4 Record), NRA & International, 3 Position, English Match & Metric, Prone, UIT	14 x 24 T	250	20	32.00
USA-50	50 FT	US Shooting Team 50 FT Competition	10 ¹ / ₂ x 12 T	1000	32	11.00

Note *1*: P = Paper / T = Tagboard / CB = 200 lb. cardboard / * Non NRA target

1.800.243.8274 □ IN NJ 908.355.8600 □ FAX 908.355.1414



NRA High Power Rifle Targets, IBS Targets

PRICES ARE PER 100 TARGETS.

PAGE 44

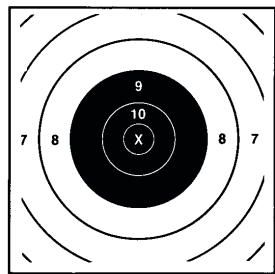

SR-C

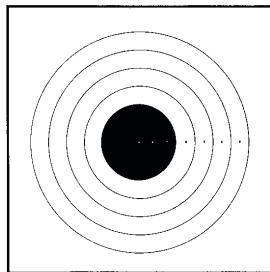

SR-1

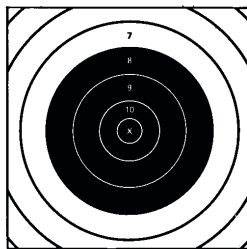

SR-3C

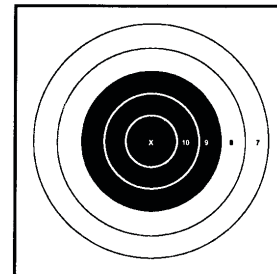

SR-5

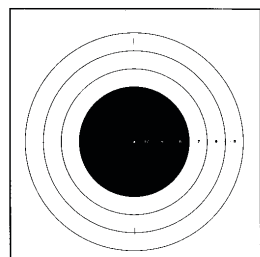

SR-21

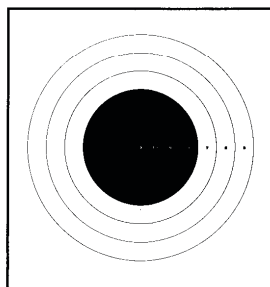

SR-42

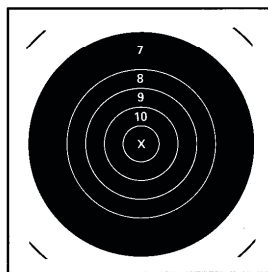

MR-1C

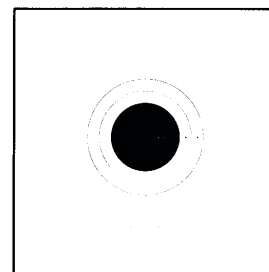

MR-31

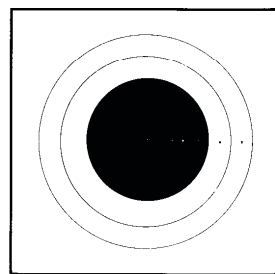

MR-52

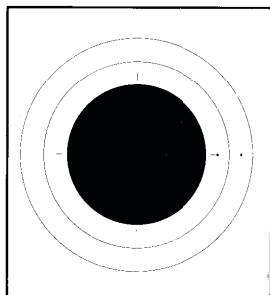

MR-63

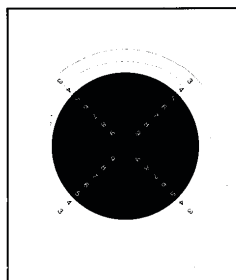

C-1

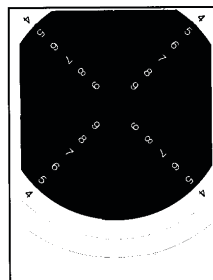

C-1C

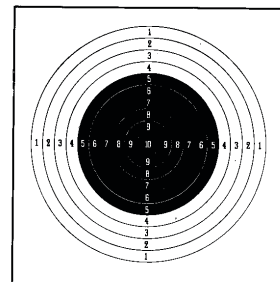

C-2

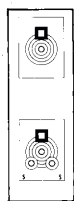

IBS-B/1 IBS-B/2

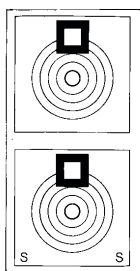

IBS-B/3

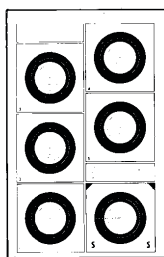

IBS-H/1

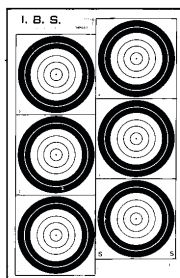

IBS-H/2

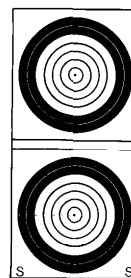

IBS-H/3



1.800.243.8274 □ IN NJ 908.355.8600 □ FAX 908.355.1414

NRA High Power Rifle Targets, IBS Targets

PRICES ARE PER 100 TARGETS.

PAGE 45

TARGET NUMBER		DESCRIPTION	SIZE ¹ / STOCK		TARGETS PER CARTON	SHIPPING WEIGHT PER CARTON	LIST PRICE PER 100
* SR	200 YD	Standard 200 YD Target	42 x 42	P	100	36	\$96.00
* SR-C	200 YD	Repair Center for SR	23 ¹ / ₂ x 23 ¹ / ₂	P	250	18	36.50
* SR-1	100 YD	Reduced 200 YD SR, Military	21 x 21	T	250	30	49.00
* SR-1 C	100 YD	Repair Center for SR-1	10 ¹ / ₂ x 10 ¹ / ₂	T	1000	30	11.00
* SR-3 C	300 YD	Repair Center for SR-3, Rapid Fire	28 x 28	P	100	14	40.00
* SR-5	200 YD	Military, same as SR except no 5 & 6 scoring rings, Narrow Scoring Rings, for Small Target Frames	28 x 28	P	100	14	40.00
* SR-21	100 YD	Reduce 300 YD SR-3, Military	21 x 21	T	250	30	49.00
* SR-21 C	100 YD	Repair Center for SR-21	10 ¹ / ₂ x 10 ¹ / ₂	T	1000	30	11.00
* SR-42	200 YD	Reduced 300 YD SR-3, Military	27 x 29	P	100	14	67.00
* SR-42 C	200 YD	Repair Center for SR-42	15 x 15	T	500	32	19.50
* MR-1 C	600 YD	Repair Center for MR - 1, 600 YD	37 x 37	P	100	20	61.00
* MR-31	100 YD	Reduced 600 YD MR-1, Military	21 x 21	T	250	30	49.00
* MR-31 C	100 YD	Repair Center for MR-31	10 ¹ / ₂ x 10 ¹ / ₂	T	1000	30	11.00
* MR-52	200 YD	Reduced 600 YD MR-1, Military	21 x 24	T	250	35	49.00
* MR-52 C	200 YD	Repair Center for MR-52	13 x 13	T	500	32	19.00
* MR-63	300 YD	Reduced 600 YD MR-1, Military	35 x 35	P	100	18	66.50
* MR-63 C	300 YD	Repair Center for MR-63	20 x 20	P	500	32	25.00
* C-1 C	300 YD	Repair Center for C-1, 300 M, UIT	20 x 28	T	250	24	55.00
* C-2	200 YD	Reduced 300 M, C-1, UIT	28 x 28	P	100	14	38.75

INTERNATIONAL BENCHREST SHOOTERS TARGETS

Prices are NET – Discounts DO NOT Apply

* IBS-B/1	100 YD	Benchrest, Black 2 Bulls (1 Sighter, 1 Score)	8 x 15 ¹ / ₂	T	500	15	9.75 Net
* IBS-B/2	200 YD	Benchrest, Black 2 Bulls (1 Sighter, 1 Score)	8 x 16 ¹ / ₂	T	500	15	9.75 Net
* IBS-B/3	300 YD	Benchrest, Red 2 Bulls (1 Sighter, 1 Score)	12 x 23 ¹ / ₂	T	250	19	29.25 Net
* IBS-H/1	100 YD	Hunter, Black 6 Bulls, (1 Sighter, 5 Score)	12 x 19	T	250	14	14.75 Net
* IBS-H/2	200 YD	Hunter, Black 6 Bulls, (1 Sighter, 5 Score)	13 x 21	T	250	15	14.75 Net
* IBS-H/3	300 YD	Hunter, Red 2 Bulls, (1 Sighter, 1 Score)	13 x 26	T	250	22	34.25 Net

Note *1*: P = Paper / T = Tagboard / CB = 200 lb. cardboard / * Non NRA target

PRICES ARE NET – DISCOUNTS DO NOT APPLY

1.800.243.8274 ◻ IN NJ 908.355.8600 ◻ FAX 908.355.1414



High Power Rifle Spotters, Spindles, Value Indicators, Group Markers, Pastors

TARGET NUMBER	DESCRIPTION	SIZE ¹ / STOCK	TARGETS PER CARTON	SHIPPING WEIGHT PER CARTON	LIST PRICE PER 100
SPO-1	1" Target Disc Spotter, Black/White, 2-300 YD Rapid Fire	1 CH	100	2	\$19.00
SPO-3	3" Target Disc Spotter, Black/White , 2-300 YD	3 CH	100	3	27.50
SPO-5	5" Target Disc Spotter, Black/White , 600-1000 YD	5 CH	100	4	36.50
SPO-10	10" Target Disc Spotter, Black/White , 1000 YD	5 CH	100	20	61.00
SPO-SW	Target Disc Spotter Spindle, Hardwood	3 ¹ / ₄ W	100	3	66.00
SPO-SP	Target Disc Spotter Spindle, Plastic	3 PL	100	3	66.00
SPO-GM380	Rapid Fire Group Marker 3/8" Orange	³ / ₈ PL	100	1	66.00
SPO-GM120	Rapid Fire Group Marker 1/2" Orange	³ / ₈ PL	100	1	66.00
SPO-GM10	Rapid Fire Group Marker 1" Orange	1 PL	100	1	66.00
SPO-GM1B	Rapid Fire Group Marker 1" Black	1 PL	100	1	66.00
SPO-GM1W	Rapid Fire Group Marker 1" White	1 PL	100	1	66.00
SPO-GM150	Rapid Fire Group Marker 1.5" Orange	1.5 PL	100	1	66.00
SPO-GM15B	Rapid Fire Group Marker 1.5" Black	1.5 PL	100	1	66.00
SPO-GM15W	Rapid Fire Group Marker 1.5" White	1.5 PL	100	1	66.00
SPO-TVI80	Target Value Indicator 8" Orange	8 PL	10	4	52.50
SPO-KIT	Assorted Value Pack	PL	60	5	48.75

Contains:

- 1 Each – SPO-TVI80
- 10 Each – SPO-GM380
- 10 Each – SPO-GM1B
- 10 Each – SPO-GM15B
- 6 Each – SPO-SP
- 10 Each – SPO-GM120
- 10 Each – SPO-GM1W
- 10 Each – SPO-GM15W

PAS-BL S	Pasters Black Square Pressure Sensitive	□	1 PSP	1000	1	7.80 Roll
PAS-BL R	Pasters Black Round Pressure Sensitive	○	³ / ₄ PSP	1000	1	7.80 Roll
PAS-WH S	Pasters White Square Pressure Sensitive	□	1 PSP	1000	1	7.80 Roll
PAS-WH R	Pasters White Round Pressure Sensitive	○	³ / ₄ PSP	1000	1	7.80 Roll
PAS-BU S	Pasters Buff Square Pressure Sensitive	□	1 PSP	1000	1	7.80 Roll
PAS-BR S	Pasters Brown Square Pressure Sensitive	□	1 PSP	1000	1	7.80 Roll
PAS-BLUE S	Pasters Blue Square Pressure Sensitive	□	1 PSP	1000	1	7.80 Roll
PAS-GR S	Pasters Green Square Pressure Sensitive	□	1 PSP	1000	1	7.80 Roll
PAS-RE R	Pasters Red Round Pressure Sensitive	○	³ / ₄ PSP	1000	1	7.80 Roll
PAS-RE R2	Pasters Red Round Pressure Sensitive	□	2 PSP	400	1	7.80 Roll

Note *1": P = Paper / CH = Chip Board / W = Hardwood / PL = Plastic / PSP = Pressure Sensitive Paper

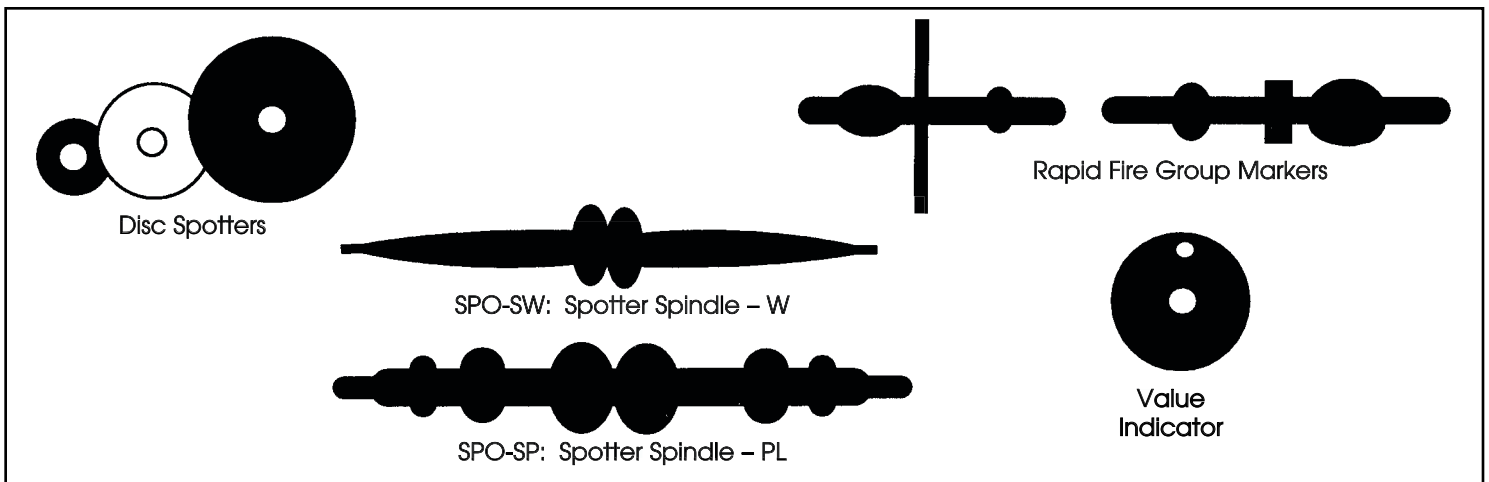

NRA Air Rifle Targets

PRICES ARE PER 100 TARGETS.

PAGE 47

TARGET NUMBER		DESCRIPTION	SIZE ¹ / STOCK	TARGETS PER CARTON	SHIPPING WEIGHT PER CARTON	LIST PRICE PER 100
AR-4/1	5 M	Air Rifle, Single Bull	6 x 8 ¹ / ₂ T	1000	11	\$ 5.25
AR-4/5	5 M	Air Rifle, 5 Bulls	8 ¹ / ₂ x 11 T	1000	30	9.75
AR-4/10	5 M	Air Rifle, 10 Bulls	12 x 14 T	1000	40	15.25
AR-5/1	10 M	Air Rifle, Single Bull	5 ¹ / ₂ x 5 ¹ / ₂ T	1000	8	3.50
AR-5/5	10 M	Air Rifle, 5 Bulls	7 x 9 T	1000	12	6.50
AR-5/10	10 M	Air Rifle, 12 Bulls, 2 Sighters Bulls, 10 Record	10 ¹ / ₂ x 12 T	1000	32	12.50
AR-6	10 M	Air Rifle, Moving Target, 2 Bulls, 1 Sighter (Replaces RB-L & RB-R)	4 x 10 ¹ / ₂ T	1000	12	6.50
AR-TYRO	10 M	Air Rifle, TYRO USA Shooting Target	6 ¹ / ₂ x 7 T	1000	15	5.25
BMC	10 M	Air Rifle / 50' Small Bore	7 x 9 T	1000	12	5.00

Note "1": T = Tagboard / *Non NRA Target

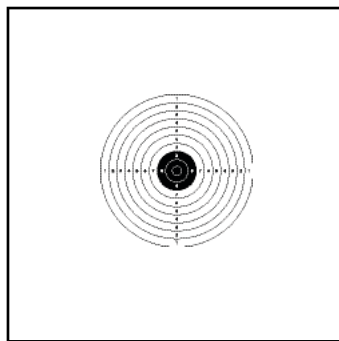

AR-4/1

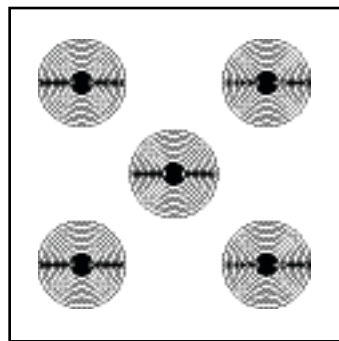

AR-4/5

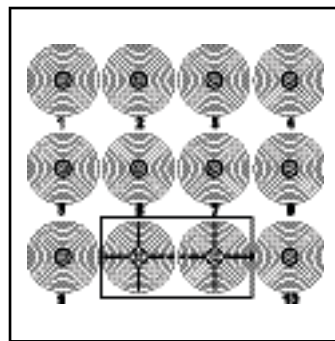

AR-4/10

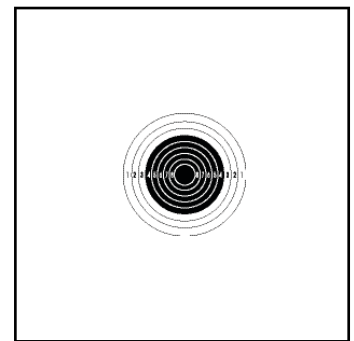

AR-5/1

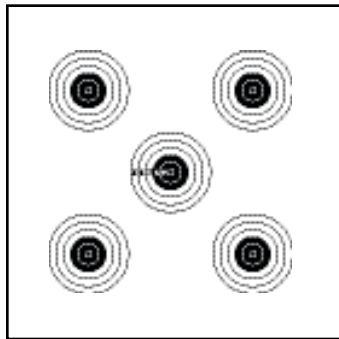

AR-5/5

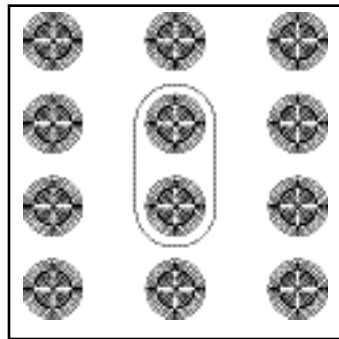

AR-5/10

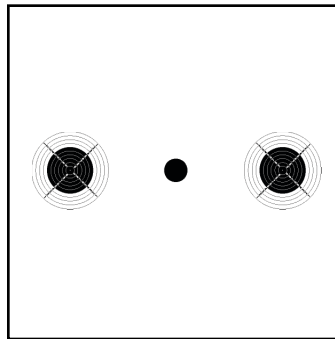

AR-6

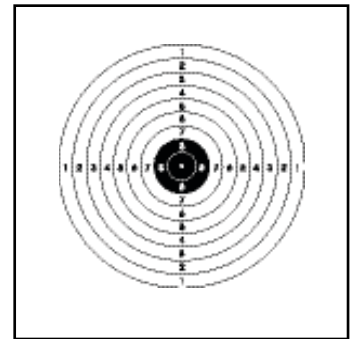

AR-TYRO

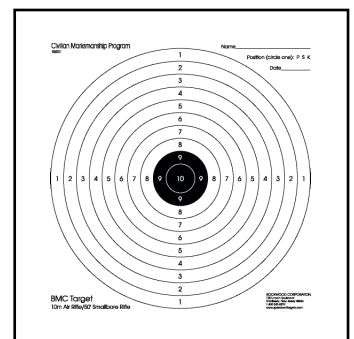

BMC

Military DOD Targets

PRICES ARE PER 100 TARGETS.

PAGE 48

TARGET NUMBER	DESCRIPTION	SIZE ¹ / STOCK	TARGETS PER CARTON	SHIPPING WEIGHT PER CARTON	LIST PRICE PER 100
DOD-A 1000	1000 Inch DCM Rifle / Carbine Target	8 1/2 x 11 T	1000	30	\$10.00
DOD-F PRONE	Silhouette "F" Prone Olive	26 1/8 x 19 1/8 T	1000	70	37.60
DOD-M16	15 Meter Indoor 15M Training Target	8 1/2 x 11 T	1000	32	10.00
DOD-M16	175 METER MILITARY TRAINING TARGET	33 X 42 1/4 T	500	100	75.68
DOD-M4	25 Meter Zeroing Target M-4 Carbine	8 3/4 x 11 T	1000	28	11.00
DOD-M16A1	25 METER ALT COURSE C RECORD FIRE	17 1/2 X 22 1/2 T	250	30	43.75
DOD-M16A1 TF	25 Meter Timed Fire Course	17-1/2 x 22 T	250	30	43.75
DOD-M16A2	25 Meter Zeroing Target	8 3/4 x 11 1/2 T	1000	28	10.00
DOD-M60	Military Training Target M-60	35 x 45 P	100	25	66.00
DOD-M9	US Army 25 Meter E Silhouette 9mm Pistol	24 x 40 P	200	22	76.00
DOD-MG 10M	Target Machine Gun ABCD 10 Meter	35 x 45 P	100	20	56.40
DOD-TRAPEZ	Target Silhouette Trapezoidal	19 1/2 x 27 1/2 P	500	40	25.25
B-60 DOD	Thug w/ Handgun DOD IG Black	22 1/2 x 35 P	200	20	47.00
BOB-1	Bobber Silhouette 1/4 Chipboard	19-1/2 x 40 CH	100	200	430.00
BOB-3	Bobber Silhouette 1/4 Chipboard	19-1/2 x 40 CH	100	75	430.00
BLACK SPOT	DOD Training Target Type I	22 2/3 x 30 P	250	30	86.00
DOD-3 DOT	3" DOT Training Target	19 x 24 P	500	32	22.00
DOT-6 DOT	6" DOT Training Target	19 x 24 P	500	32	22.00

Note ¹: P = Paper / T = Tagboard / CB = 200 lb. cardboard / Non NRA target



DOD-M16A1

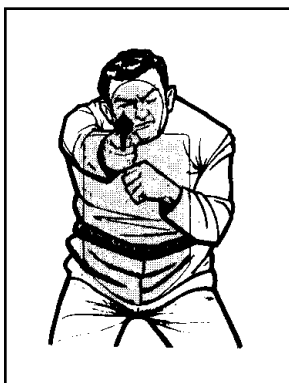

B-60 DOD

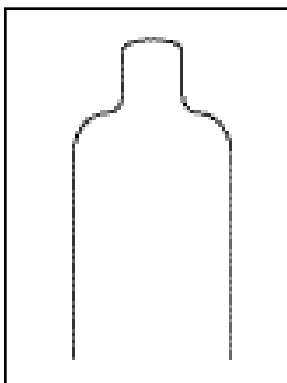

BOB-1

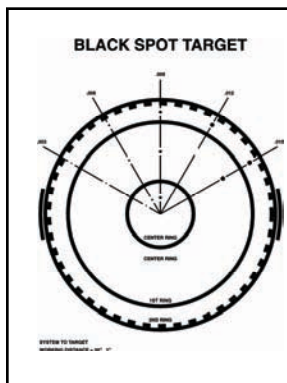

BLACK SPOT

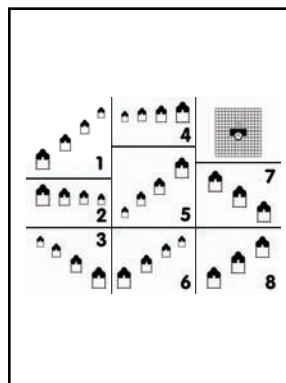

DOD-M60

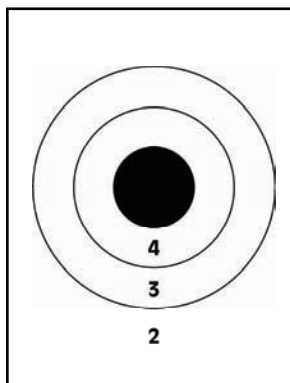

DOD-A 1000

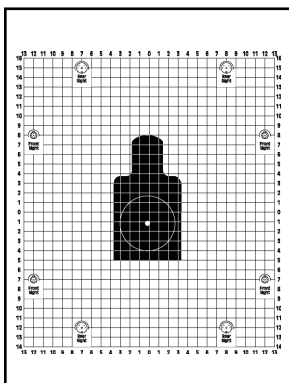

DOD-M16A2

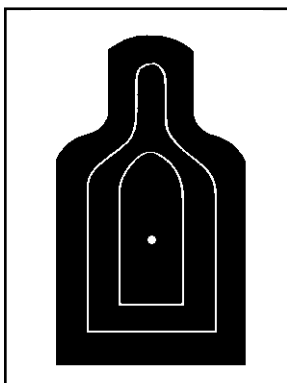

DOD-M9

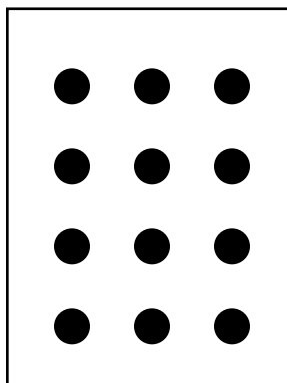

DOD-3 DOT

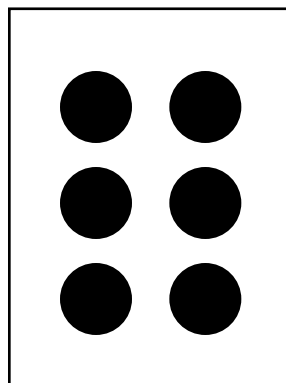

DOT-6 DOT



1.800.243.8274 □ IN NJ 908.355.8600 □ FAX 908.355.1414

Sighting Targets

PRICES ARE PER 100 TARGETS.

PAGE 49

TARGET NUMBER		DESCRIPTION	SIZE ¹ / STOCK		TARGETS PER CARTON	SHIPPING WEIGHT PER CARTON	LIST PRICE PER 100
S-5	100 YD	Sighting Target, 1" Grid, Round Bull, Red	14 x 14	P	500	15	\$12.75
ST-1	50 YD	M1 Rifle & M72 Match Ammunition	14 x 30	T	100	10	47.00
ST-2	40 YD	Shotgun Patterning, Claybird Bull	35 x 45	P	100	20	66.50
ST-3	100 YD	Rifle Sighting Target, White Index	14 x 14	T	500	32	23.50
G-R	VAR	Scoped Rifle Sighting Target, 1" Grid Red	16 x 16	P	500	25	25.25
G-E	100 YD	Big Bore Rifle, 8" Bull, White Center	9 x 10	P	1000	9	8.00
RD-4	100 YD	Deer Target	22 1/2 x 35	P	100	10	42.00
TM-1	50 FT	Rifle Silhouette, Turkey	10 1/2 x 12	P	500	10	11.00
SIM	VAR	Simmons Scoped Rifle Target	16 1/2 x 20	P	500	10	18.25

ANIMAL "PLINKING" TARGETS

G-23	VAR	Rabbit	9 x 10	P	250	9	8.00
G-24	VAR	Rabbit - Crow - Turkey - Woodchuck	10 1/2 x 12	P	250	8	8.00
G-25	VAR	Woodchuck - Raccoon - Fox - Turkey - Rabbit - Crow Bullseye - Squirrel	10 1/2 x 12	P	250	8	8.00
G-26	VAR	Woodchuck	10 x 14	P	250	10	8.00
TQ-12	50 FT	2 Chicken, 2 Pigs	10 1/2 x 12	T	250	8	11.00
TQ-13	50 FT	2 Turkeys, 2 Rams	10 1/2 x 12	T	250	8	11.00
TQ-14	50 FT	5 Chickens, 5 Pigs, 5 Turkeys, 5 Rams	10 1/2 x 12	T	250	8	11.00

"GAMES OF CHANCE" FUN TARGETS

PT-1	50 YD	Poker, 52 card deck target	12 1/2 x 12 1/2	T	250	20	19.25
LT-1	VAR	Turkey Shoot, Small Luck Target	7 x 9 1/2	P	250	4	9.00
LT-2	VAR	Turkey Shoot, Large Luck Target	10 1/2 x 12	P	250	8	11.00
MT-1	50 YD	Moonlight Target, 5 Bulls	14 x 14	T	250	16	22.25
MT-2	100 YD	Moonlight Target, 5 Bulls	14 x 20	T	250	18	28.50

ARCHERY TARGETS

G-N	VAR	8-1/2" Bull, 2" Red X Center	9 x 10	P	1000	9	8.00
G-NA	VAR	8" Bull, White X, 1-1/2" Red Center	9 x 10	P	1000	9	8.00
G-66	VAR	Indoor Archery Target, Blue	17 x 17	P	250	14	27.00
G-67	VAR	5 Spot Archery Target, Blue	17 x 17	P	250	14	27.00
G-68	VAR	4 Color Archery Target, 1-10 Rings	17 x 17	P	250	14	44.50
G-69	VAR	Turkey Target with Vitals	17 1/2 x 23	P	250	18	42.00

MUZZLE LOADING TARGETS

* ML-25P	25 YD	Single Bull, 25 YD Timed Fire ML, Round Ball, Pistol Target	21 x 24	T	100	16	\$30.00 NET
* ML-50R	VAR	6 Bulls, 25 & 50 YD Round Ball, ML Rifle Target, 8, 9, 10 Rings	17 1/2 x 22	T	100	12	31.25 NET
* ML-50B	50 YD	Single Bull, 50 YD, ML, Round Ball, Buffalo Target	17 1/2 x 22	T	100	12	31.25 NET
ML-50B2	50 YD	Double Bull, 50 YD, ML, Round Ball, Buffalo Target	17 1/2 x 22	T	100	12	31.25 NET
* ML-100	100 YD	Single Bull, 100 YD, ML, Round Ball, Rifle Target 8, 9, 10 Rings	14 x 16	t	100	10	25.00 NET
* ML-SG	50 YD	Six Bulls, 50 YD, ML, Slug Gun Target	17 1/2 x 22	T	100	10	31.25 NET
* ML-FDL	50 YD	3-1/2 Bulls, 50 YD, ML, Fur-Du-Lac Target	16 x 28	t	100	14	31.25 NET
* FR-CON	200 YD	French Concours, Muzzle Loading Target	35 x 45	P	100	20	42.00 NET

Note *1": P = Paper / T = Tagboard / * Non NRA target

1.800.243.8274 □ IN NJ 908.355.8600 □ FAX 908.355.1414



Gallery & Sighting Targets

PRICES ARE PER 100 TARGETS.

PAGE 50

TARGET NUMBER	DESCRIPTION	SIZE ¹ / STOCK		TARGETS PER CARTON	SHIPPING WEIGHT PER CARTON	LIST PRICE PER 100
G-15	25 YD Slow Fire Pistol	10 ¹ / ₂ x 12	P	1000	18	\$8.00
G-16	50 FT Slow Fire Pistol	10 x 12	P	1000	18	8.00
G-17	50 FT Timed And Rapid Pistol	10 x 12	P	1000	18	8.00
G-21	25 F Thug w/ Handgun	9 ¹ / ₂ x 14	P	1000	20	8.00
G-22	25 FT Small 5X Silhouette Target	9 ¹ / ₂ x 14	P	1000	18	8.00
G-23	Rabbit – (same as AN-23)	9 x 10	P	250	9	8.00
G-24	Rabbit, Crow, Turkey, Woodchuck	10 ¹ / ₂ x 12	P	250	8	8.00
G-25	Woodchuck, Raccoon, Fox, Turkey, Rabbit, Crow, Squirrel	10 ¹ / ₂ x 12	P	250	8	8.00
G-26	Woodchuck	10 x 14	P	250	10	8.00
G-28	100 YD Large Bore Rifle	14 x 14	P	1000	30	10.00
G-31	25 YD Rifle and Pistol Target	14 x 14	P	1000	30	10.00
G-46	50 F Thug w/ Handgun, Black	14 x 23	P	500	22	25.25
G-47	50 FT 5X Silhouette Target, Black	14 x 23	P	500	22	25.25
G-50	Shotgun Pattern Target	23 x 23	P	100	14	42.00
G-52	Thug Silhouette	20 x 29	P	250	32	42.00
G-53	5X Silhouette	20 x 29	P	250	32	42.00
G-60	Terrorist	20 x 29	P	100	11	56.00
G-60A	Blue 1 up 6" Bull	6 ¹ / ₂ x 6 ¹ / ₂	P	250	11	6.50
G-60B	Blue 2 up 2 – 6" Bull	6 ¹ / ₂ x 13	P	250	14	11.00
G-64	Vital Organs Silhouette	20 x 30	P	100	12	42.00
G-66	Indoor Archery Target, Blue	17 x 17	P	250	14	27.00
G-67	5 Spot Archery Target, Blue	17 x 17	P	250	14	27.00
G-68	4 Color Archery Target 1-10 Rings	17 x 17	P	250	14	44.50
G-69	Turkey Archery Target w/ vitals	17 ¹ / ₂ x 23	P	250	18	42.00
G-A	6" Bull 1" White Center	6 ¹ / ₂ x 7	P	1000	10	6.50
G-B	8" Bull 1 ³ / ₈ " Red Center w/ 3 Rings	9 x 9	P	1000	10	8.00
G-BB	Combat Sighting in Pistol Target	9 ¹ / ₂ x 10	P	1000	14	8.00
G-C	5-3" Bulls, Each w/ Red Centers	9 x 9	P	1000	10	8.00
G-C/C	Boxed with 1 ³ / ₄ " Red Center	7 x 10 ¹ / ₂	P	1000	12	8.00
G-D	8" Bull w/ Red Center and 3 Rings	9 x 9	P	1000	10	8.00
G-E	8" Bull White Center 3 Red w/ 1 White Outer	9 x 9	P	1000	10	8.00
G-F	8" Bull White w. Red 2 RG Center White Outer Ring	9 x 9	P	1000	10	8.00
G-I	5-4" Bull 2 ¹ / ₂ Red Center ³ / ₄ Red Outer	10 x 7 ¹ / ₂	P	1000	14	8.00
G-J	12" Bull 2" White Center 2 ¹ / ₈ w/ Red/White	13 x 13 ¹ / ₂	P	500	20	25.25
G-K	15" Bull Red Center 9876 White Rings	16 x 16	P	500	20	25.25
G-L	B-24 Silhouette Red	12 x 19	P	500	20	25.25
G-M	B-34 Silhouette Red	13 x 23	P	500	20	25.25
G-N	8 ¹ / ₂ " Bull 2" Center	9 ¹ / ₂ x 9 ¹ / ₂	P	1000	10	8.00
G-N/A	8" Bull 1 ¹ / ₂ " Red Center	9 x 9	P	1000	10	8.00
G-R	Scoped Rifle Sighting Target, 1" Grid Red	16 x 16	P	500	25	25.25
G-T	8" Bull 2" White Center	9 x 9	P	1000	10	8.00
G-U	6" Red Bulls with 2" White Center	9 ¹ / ₂ x 17	P	250	12	21.00
G-V	Silhouette with Red Head & Chest	11 x 17	P	250	12	21.00
G-Y	8" Bull 1" White Center w/3 Red Rings	9 x 9	P	1000	10	8.00
G-W	50 YD Small Bore Red 5 Bulls	13 ¹ / ₂ x 13	P	500	20	21.00
G-X	10" Bull 2 ¹ / ₂ Red Center, 7, 8, 9 Rings	11 x 11 ¹ / ₂	P	500	20	21.00
G-Z	50 YD Reduced Rapid Fire Silhouette Red	17 ¹ / ₂ x 6	P	250	11	21.00



1.800.243.8274 □ IN NJ 908.355.8600 □ FAX 908.355.1414

Gallery & Sighting Targets

PRICES ARE PER 100 TARGETS.

PAGE 51

TARGET NUMBER	DESCRIPTION	SIZE ¹ / STOCK	TARGETS PER CARTON	SHIPPING WEIGHT PER CARTON	LIST PRICE PER 100
* B-2 G 50 FT	Slow Fire, Indoor Gallery	10 ¹ / ₂ x 12 P	1000	15	\$12.00
* B-6 G 50 YD	Slow Fire, NRA American Standard	21 x 24 P	500	35	25.00
* B-8 G 25 YD	Timed and Rapid Fire, Competition	21 x 24 P	500	35	25.00
* B-16 G 25 YD	Slow Fire	10 ¹ / ₂ x 12 P	1000	32	12.00
* B-17 G 50 M	Slow Fire, UIT, Free Pistol, Precision	21 x 24 P	500	35	25.00
* B-40 G 10 M	Air Pistol (33 FT), Single Bull	7 x 8 P	1000	13	8.00
* B-40 / 4G 10 M	Air Pistol (33 FT), 4 Bulls	14 x 14 P	500	25	20.50
* A-17 G 50 FT	Small Bore, 11 Bulls (1 Sighter, 10 Record)	10 ¹ / ₂ x 12 P	1000	15	12.00
* A-23 / 3G 50 YD	Tournament, Top Sighter, 3 Bulls	14 x 24 P	500	30	33.00
* S-5 100 YD	Sighting Target, 1" Grid, Round Bull, Red	14 x 14 P	1000	30	12.75

Pasters

PAS-RE 1/2	1/2" Round Pasters Red Pressure Sensitive	P	110	1	\$3.80
PAS-RE 1	1" Round Pasters Red Pressure Sensitive	P	100	1	3.80
PAS-RE 1 1/2	1 1/2" Round Pasters Red Pressure Sensitive	P	70	1	3.80
PAS-RE 2	2" Round Pasters Red Pressure Sensitive	P	45	1	3.80
PAS-RE 3	3" Round Pasters Red Pressure Sensitive	P	25	1	3.80
PAS-RE 5 1/2	5 1/2" Round Pasters Red Pressure Sensitive	P	15	1	3.80

Note "1": P = Paper / T = Tagboard / * Non NRA target

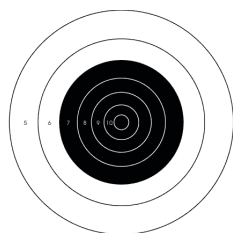

G-15

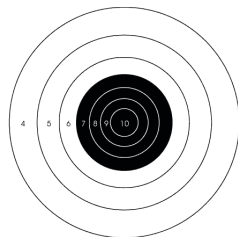

G-16

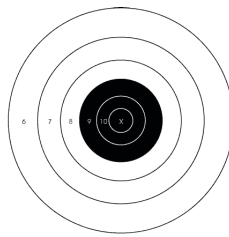

G-17

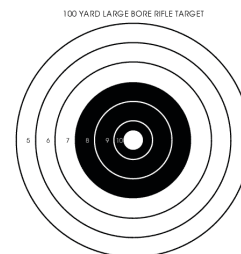

G-28

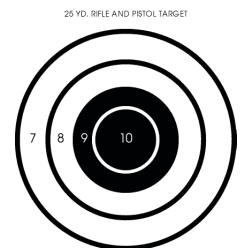

G-31



G-50



G-60A



G-60B

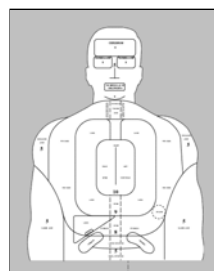

G-64



G-66



G-67

Gallery & Sighting Targets

PRICES ARE PER 100 TARGETS.

PAGE 52

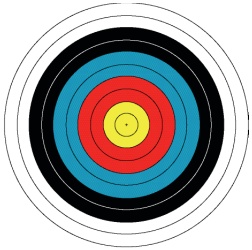

G-68



G-A



G-B



G-B/B

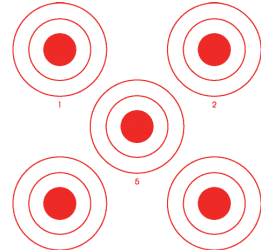

G-C

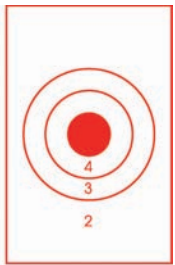

G-C/C



G-D



G-E

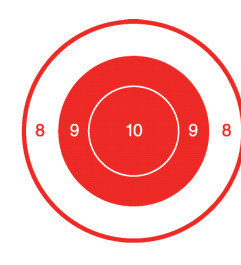

G-F



G-I



G-J



G-K



G-L



G-M



G-N

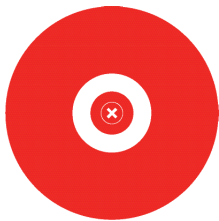

G-N/A

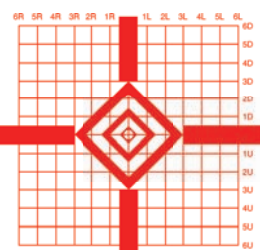

G-R



G-T

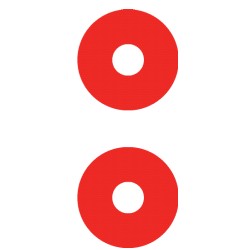

G-U

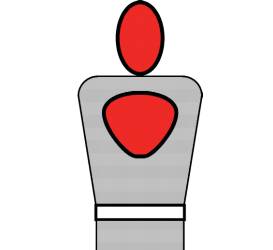

G-V



1.800.243.8274 □ IN NJ 908.355.8600 □ FAX 908.355.1414

Gallery & Sighting Targets

PRICES ARE PER 100 TARGETS.

PAGE 53

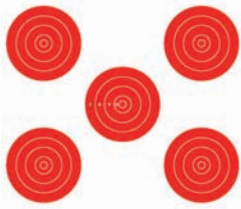

G-W

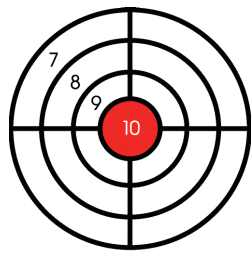

G-X



G-Y



G-Z



G-21 / G-46 / G-52

Archery Targets

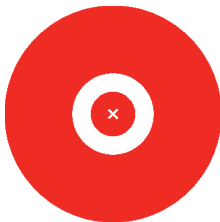

G-NA

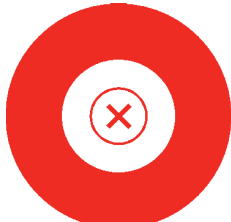

G-N

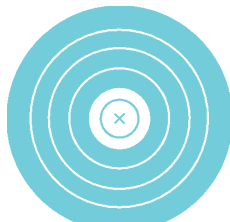

G-66

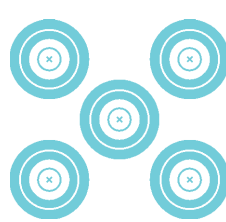

G-67

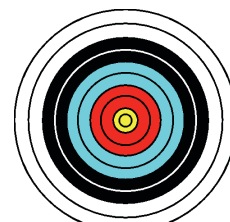

G-68



G-69

Sighting Targets

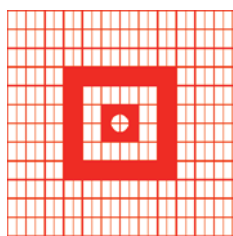

S-5

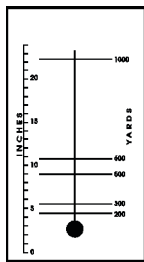

ST-1

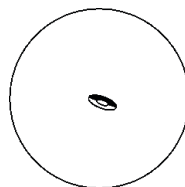

ST-2

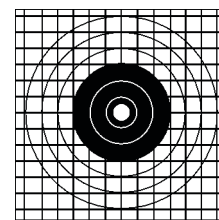

ST-3

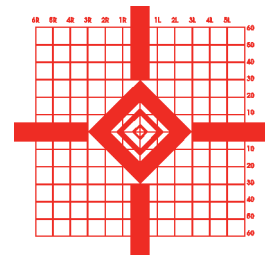

G-R



G-E

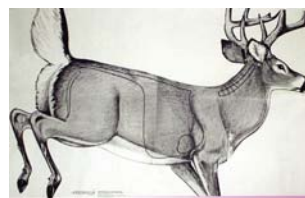

RD-4

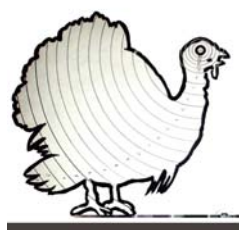

TM-1

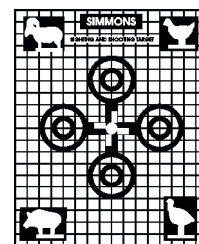

SIM



Gallery & Sighting Targets

PRICES ARE PER 100 TARGETS.

Animal Plinking Targets



G-23



G-24

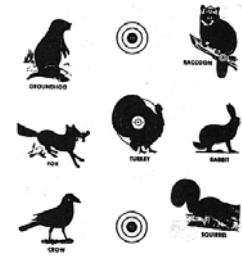

G-25



G-26

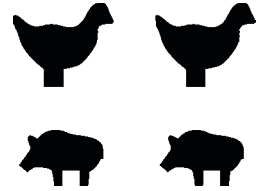

TQ-12

"Game of Chance" Fun Targets

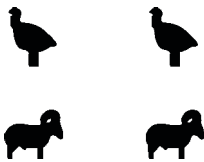

TQ-13



TQ-14

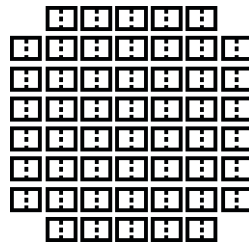

PT-1

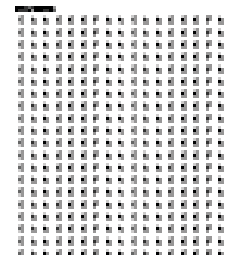

LT-1 / LT-2

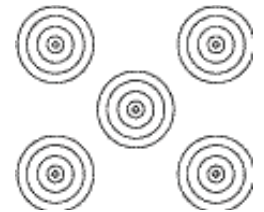

MT-1 / MT-2

Muzzle Loading targets

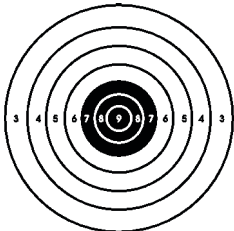

ML-25P

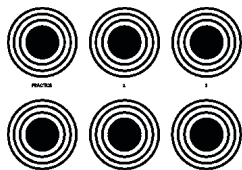

ML-50R



ML-50B

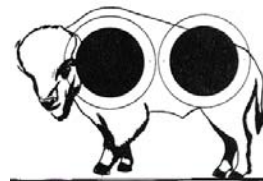

ML-50B2

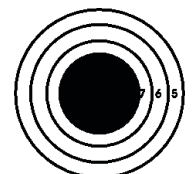

ML-100

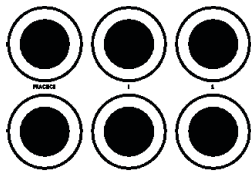

ML-SG

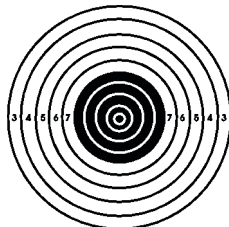

FR-CON

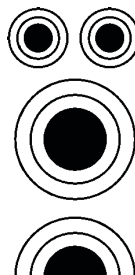

ML-FDL

Bullseye Gallery Target

PRICES ARE PER 100 TARGETS.

PAGE 55

TARGET NUMBER		DESCRIPTION	SIZE ¹ / STOCK	TARGETS PER CARTON	SHIPPING WEIGHT PER CARTON	LIST PRICE PER 100
* B-2 G	50 FT	Slow Fire, Indoor Gallery	10 1/2 x 12 P	1000	15	\$12.00
* B-6 G	50 YD	Slow Fire, NRA American Standard	21 x 24 P	500	35	25.00
* B-8 G	25 YD	Timed and Rapid Fire, Competition	21 x 24 P	500	35	25.00
* B-16 G	25 YD	Slow Fire	10 1/2 x 12 P	1000	32	12.00
* B-17 G	50 M	Slow Fire, UIT, Free Pistol, Precision	21 x 24 P	500	35	25.00
* B-40 G	10 M	Air Pistol (33 FT), Single Bull	7 x 8 P	1000	13	8.00
* B-40 / 4G	10 M	Air Pistol (33 FT), 4 Bulls	14 x 14 P	500	25	20.50
* A-17 G	50 FT	Small Bore, 11 Bulls (1 Sighter, 10 Record)	10 1/2 x 12 P	1000	15	12.00
* A-23 / 3G	50 YD	Tournament, Top Sighter, 3 Bulls	14 x 24 P	500	30	33.00
* S-5	100 YD	Sighting Target, 1" Grid, Round Bull, Red	14 x 14 P	500	30	12.75

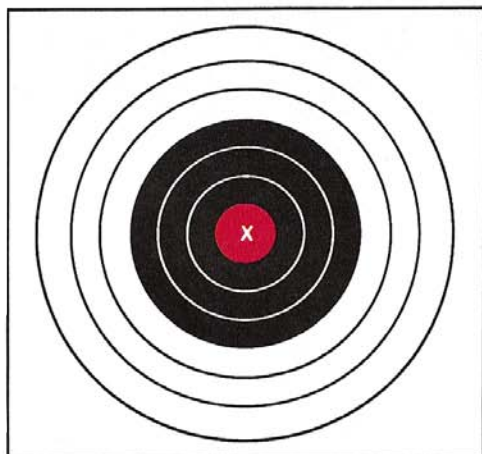

B-6 G



A-23 / 3 G



A-17 G



B-16 G

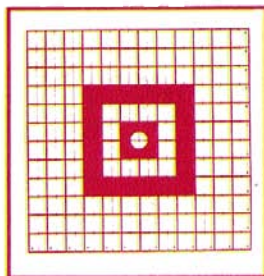

S-5

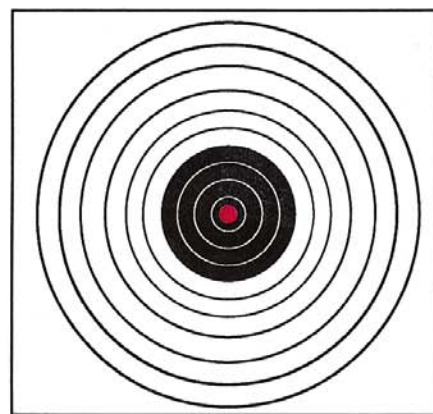

B-40 G

Reactive "Sealite"™ Plastic Targets

Speedwell™ "SEALITE"™ Targets manufactured of high visibility orange polymer, are self sealing and will literally take over a thousand hits. SEALITE Targets eliminate the hazards of steel targets. They will perform in both low and high temperature ranges without softening or cracking

TARGET NUMBER	DESCRIPTION	TARGET SIZE	SHIPPING WEIGHT	LIST PRICE
ST-PR 6P	Steel Plate Rack, 6 x 8" Round Plastic Plates Mounted on competition spec table 45" high x 10' long. Reset with single handle or remotely with pull cord	45" x 10"	250	\$1425.00
PP-8 AR	Plastic Plate, 8" Round, w/Base, and automatic reset - 1/2" Thick	8"	1.5	64.95
PP-H AR	Plastic Plate, 8" Heart, w/Base, and automatic reset - 1/2" Thick	8"	1.5	64.95
PP-S AR	Plastic Plate, 8" Spade, w/Base, and automatic reset - 1/2" Thick	8"	1.5	64.95
PP-D AR	Plastic Plate, 8" Diamond, w/Base, and automatic reset - 1/2" Thick	8"	1.5	64.95
PP-C AR	Plastic Plate, 8" Club, w/Base, and automatic reset - 1/2" Thick	8"	1.5	64.95
PP-BP AR	Plastic Plate, 8" Bowling Pin, w/Base, and automatic reset - 1/2" Thick	18"	2	72.95

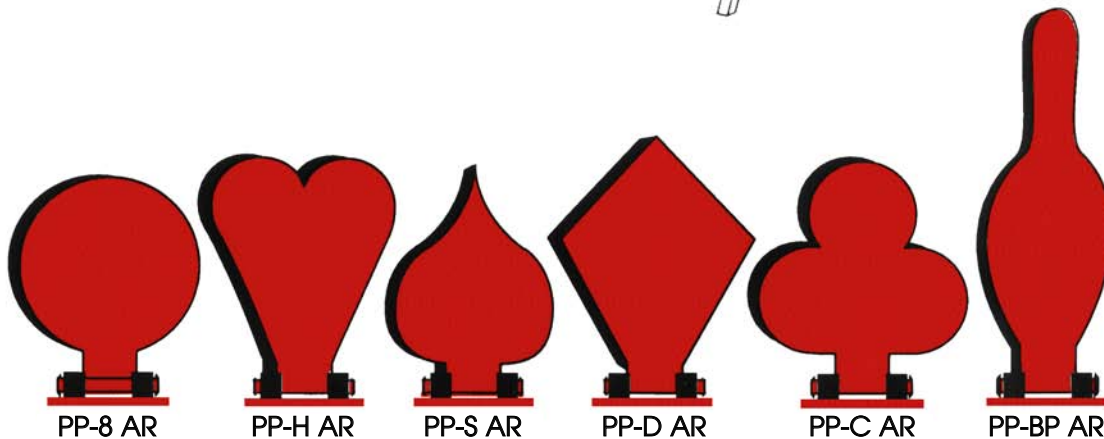
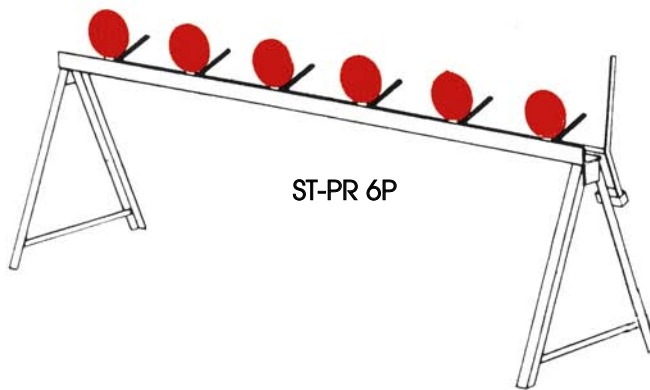



The Long Gun Data Books™ were developed by Christopher Rodgers and provide a unique system to efficiently organize, document and access critical information related to tactical observation and long range shooting situations.

Three data books offer a variety of formulas, charts and formatted information which is vital to accurate training and legal documentation.

Provide your marksman with the The Long Gun Data Books™ today and benefit immediately with standardized record keeping and enhanced performance.

DATA BOOK 1

Provides the foundation for training documentation, observation technique and precision shooting. Best suited as a training aid. Excellent resource for logging detailed information that would not normally be required on an operation. Incorporates a series of removable formatted training logs for supervisors and external record keeping. Black Cordura™ zip cover with pouch, 3-ring internal poly-binder, large tabbed sections include: Communications, Observations, Range Estimations, Elevations, Wind & Moving Targets, Cold Bore & Temperature Logs, Conversion Table & Training Logs.

Operational & Common Range Data Cards. Each section loaded with various

charts and marksmanship information. 68 double-sided pages, measures 9" x 7" x 1 1/2".

DB-1 SW 1lb \$69.95

DATA BOOK 2

Same basic format as Data Book 1 with-out the non-operational administrative logs. Tailored to meet the needs of the operational personnel in the field. Compact, waterproof never-tear paper will hold up in any environment. Black Cordura™ zip cover with internal pouch, two hole internal poly cover, low profile tabbed sections. Red lens flashlight & temp. gauge. 38 double-sided pages, measures 8" x 5 3/4" x 3/4".

DB-2 SW 1lb \$89.95

DATA BOOK 3

Fitting in the palm of your hand, this data book is the perfect reference to keep with your weapon at all times. Same basic format as above, but condensed to include some helpful hints and Mill scale chart for estimating ranges. Spiral bound poly-cover, waterproof never-tear paper, 27 double-sided pages, measures 4 1/4" x 3 1/2" x 1/8".

DB-3 SW 1/2lb \$19.95

COMPLETE DATA BOOK SYSTEM

Value \$164.85 / Special purchase all three Long Gun Data Books™

DB-4 SW 2 1/2lb \$169.95



TRAINING

DOCUMENTATION

OPERATIONAL

LIABILITY

SHOT LOG / DATA CARD SYSTEM

Developed for the law enforcement marksman, our new Shot Log/Data Card System™ will provide the most versatile and compact record keeping log available today. Formatted information is provided on each side of the Shot Log/Data Cards enabling the marksman to efficiently log pre & post shooting information. Each Shot Log/Data Card comes complete with our full size and mini T-Section Targets. Place the full size target down range and paste the mini target in the space provided. With the exact image of the target being observed located at the shooters position, bullet placement and all necessary information can be recorded with consistency and precision.

Once target is fired upon and cards are completed, simply fold target in half and combine with matching Shot Log / Data Card. The shooter now has a complete admissible record of marksmanship and training performance which can be submitted in the event of litigation.

The system includes: forty 8-1/2" x 5-1/2" heavy card stock Shot Log / Data Cards, forty 8-1/2" x 11" heavy card stock T-Section Targets, forty mini targets, 3- ring binder and thermometer.

STS-1 SW 1lb. \$44.95

Date:	Hour:	Log Number:
Shooter:	Agency / Dept:	Elevation:
Location:	Agency / Dept:	Scope:
Ammunition used:	Iron Sight used:	Zero:
		Log Number:
Type of shot: <input type="checkbox"/> Cold Bore Shot <input type="checkbox"/> Angle Shot <input type="checkbox"/> Shooting a Group <input type="checkbox"/> Qualification		
<input type="checkbox"/> Training Exercise <input type="checkbox"/> Weapon proficiency (bench rest) <input type="checkbox"/> Competition <input type="checkbox"/> Other		
<input type="checkbox"/> Supported <input type="checkbox"/> Un-supported	Shooting Position:	
Set-up time: Begin: End: Total time:		
Comments concerning performance:		
Witness: Name: Title:		

Light Direction	Weather Conditions	Wind Direction	Velocity	Elevation	Windage
<input type="checkbox"/> Day <input type="checkbox"/> Night	Barometric: <input type="checkbox"/> Sunny <input type="checkbox"/> Partly cloudy <input type="checkbox"/> Fair <input type="checkbox"/> Rain <input type="checkbox"/> Snow <input type="checkbox"/> Fog	<input type="checkbox"/> Light <input type="checkbox"/> Heavy	<input type="checkbox"/> None <input type="checkbox"/> High	<input type="checkbox"/> None <input type="checkbox"/> High	<input type="checkbox"/> None <input type="checkbox"/> High
Light Direction	Weather Conditions	Wind Direction	Velocity	Elevation	Windage
<input type="checkbox"/> Day <input type="checkbox"/> Night	Barometric: <input type="checkbox"/> Sunny <input type="checkbox"/> Partly cloudy <input type="checkbox"/> Fair <input type="checkbox"/> Rain <input type="checkbox"/> Snow <input type="checkbox"/> Fog	<input type="checkbox"/> Light <input type="checkbox"/> Heavy	<input type="checkbox"/> None <input type="checkbox"/> High	<input type="checkbox"/> None <input type="checkbox"/> High	<input type="checkbox"/> None <input type="checkbox"/> High
Remarks					
Word Line <input type="checkbox"/> Moving <input type="checkbox"/> Stationary					
Grip Position Sight Alignment Sight Picture Breathing Trigger Control Follow Through					

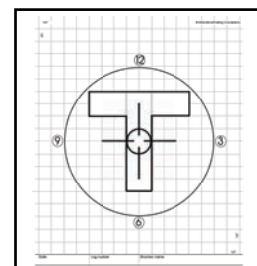

T-Section Target™



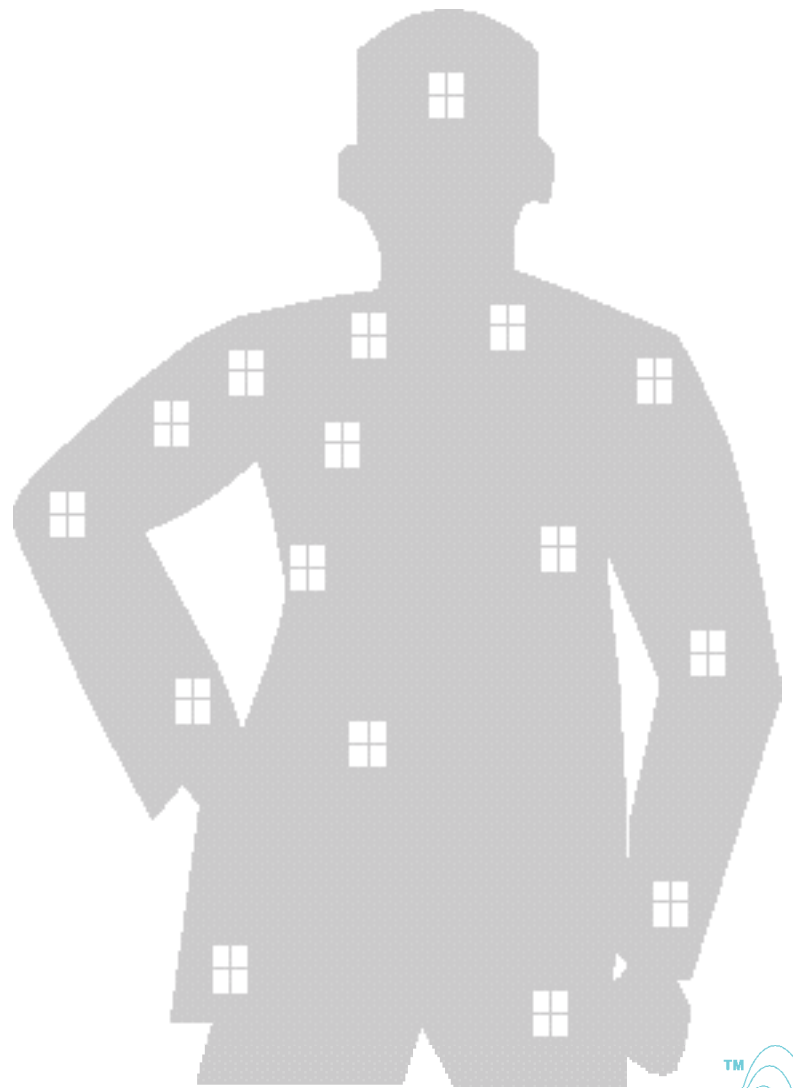

Special Police Target Sample Pack

NEW 600
SERIES COLOR
TARGETS

Designed Specifically for Advanced In-Service Tactical
Police Firearms Training

SP-50 – 50 TARGETS

\$31⁷⁵

25 Series 500, 10 Series 600 Color
REALISTIC SITUATION™ Targets &
Overlays PLUS 15 ADVANCED
"CENTER MASS" Tactical Training
Targets.

(Plus shipping & Handling \$5.00)

SP-100 – 100 TARGETS

\$58²⁵

50 Series 500, 25 Series 600 Color
REALISTIC SITUATION™ Targets &
Overlays PLUS 15 ADVANCED
"CENTER MASS" Tactical Training
Targets.

(Plus shipping & Handling \$8.50)



To Order Use Order Blank or CALL TOLL FREE **1.800.243.8274**



410 Clermont Terrace, Suite D
Union, New Jersey 07083

Address Correction Requested